

## Overview

The KEMET Organic Capacitor (KO-CAP) is a tantalum capacitor with a Ta anode and Ta<sub>2</sub>O<sub>5</sub> dielectric. A conductive organic polymer replaces the traditionally used MnO<sub>2</sub> as the cathode plate of the capacitor. This results in very low ESR and improved capacitance retention at high frequency. The KO-CAP also exhibits a benign failure mode which eliminates the ignition failures that can occur in standard MnO<sub>2</sub> tantalum types. KO-CAPs may also be operated at steady state voltages up to 90% of rated voltage for part types with rated voltages of ≤ 10 volts and up to 80% of rated voltage for part types > 10 volts with equivalent or better reliability than traditional MnO<sub>2</sub> tantalum capacitors operated at 50% of rated voltage.

The T520 Series KO-CAP Low ESR Polymer captures the best features of multilayer ceramic (low ESR, high frequency capacitance retention), aluminum electrolytic (higher capacitance, benign failure mode), and proven solid tantalum technology (volumetric efficiency, surface mount capability, extremely long life). The T520 can reduce component counts, eliminate through-hole assembly by replacing cumbersome leaded aluminum capacitors, and offer a cost-effective and space-saving solution.

## Benefits

- Extremely low ESR
- -55°C to 105°C operating temperature range
- Polymer cathode technology
- High frequency capacitance retention
- Non-ignition failure mode
- Capacitance up to 1,500 µF
- 100% accelerated steady state aging
- 100% surge current tested
- Taped and reeled per EIA 481
- Volumetric efficiency
- Self-healing mechanism
- EIA standard case sizes

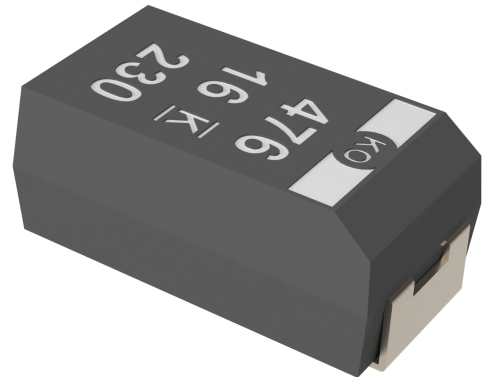

## Environmental Compliance

RoHS Compliant (6/6) according to Directive 2002/95/EC when ordered with 100% Sn solder.



RoHS Compliant

## SPICE

For a detailed analysis of specific part numbers, please visit [www.kemet.com](http://www.kemet.com) for a free download of KEMET's SPICE software. The KEMET SPICE program is freeware intended to aid design engineers in analyzing the performance of these capacitors over frequency, temperature, ripple, and DC bias conditions.

## Applications

Typical applications include DC/DC converters, notebook PCs, portable electronics, telecommunications (mobile phone and base station), displays, SSD, HDD and USB.

## Ordering Information

T	520	V	157	M	006	A	T	E045	
Capacitor Class	Series	Case Size	Capacitance Code (pF)	Capacitance Tolerance	Voltage	Failure Rate/Design	Lead Material	ESR Code	Packaging (C-Spec)
T = Tantalum	520 = Polymer	A, B, C, D, H, L, M, Q, T, U, V, W, X, Y	First two digits represent significant figures. Third digit specifies number of zeros.	M = ±20%	2R5 = 2.5 V 003 = 3 V 004 = 4 V 006 = 6.3 V 008 = 8 V 010 = 10 V 011 = 11 V 12R = 12.5 V 016 = 16 V 020 = 20 V 025 = 25 V	A = N/A	T = 100% Matte Tin (Sn) Plated H = Tin/Lead (SnPb) Solder Coated (5% Pb minimum)	E = ESR Last three digits specify ESR in mΩ. (045 = 45 mΩ)	Blank = 7" Reel 7280 = 13" Reel

## Performance Characteristics

Item	Performance Characteristics
Operating Temperature	-55°C to 105°C
Rated Capacitance Range	10 – 1,500 μF @ 120 Hz/25°C
Capacitance Tolerance	M Tolerance (20%)
Rated Voltage Range	2.5 – 25 V
DF (120 Hz)	≤ 10%
ESR (100 kHz)	Refer to Part Number Electrical Specification Table
Leakage Current	≤ 0.1 CV (μA) at rated voltage after 5 minutes

## Qualification

Test	Condition	Characteristics				
Endurance	105°C @ rated voltage, 2,000 hours	Δ C/C	Within -20%/+10% of initial value			
		DF	Within initial limits			
		DCL	Within 1.25 x initial limit			
		ESR	Within 2.0 x initial limit			
Storage Life	105°C @ 0 volts, 2,000 hours	Δ C/C	Within -20%/+10% of initial value			
		DF	Within initial limits			
		DCL	Within 1.25 x initial limit			
		ESR	Within 2.0 x initial limit			
Humidity	60°C, 90% RH, 500 hours, No Load	Δ C/C	Within -5%/+35% of initial value			
		DF	Within initial limits			
		DCL	Within 5.0 x initial limit			
		ESR	Within 2.0 x initial limit			
Temperature Stability	Extreme temperature exposure at a succession of continuous steps at +25°C, -55°C, +25°C, +85°C, +105°C, +25°C		+25°C	-55°C	+85°C	+105°C
		Δ C/C	IL*	±20%	±20%	±30%
		DF	IL	IL	1.2 x IL	1.5 x IL
Surge Voltage	105°C, 1.32 x rated voltage, 1,000 cycles	Δ C/C	Within -20%/+10% of initial value			
		DF	Within initial limits			
		DCL	Within initial limits			
Mechanical Shock/Vibration	MIL-STD-202, Method 213, Condition I, 100 G peak. MIL-STD-202, Method 204, Condition D, 10 Hz to 2,000 Hz, 20 G peak	Δ C/C	Within ±10% of initial value			
		DF	Within initial limits			
		DCL	Within initial limits			

\*IL = Initial limit

## Electrical Characteristics

ESR vs. Frequency

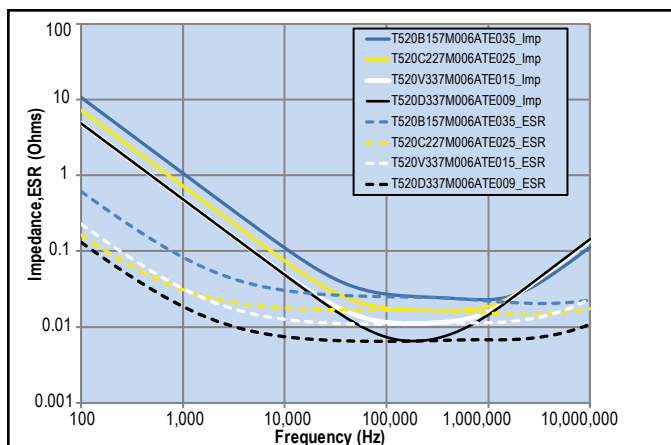

Capacitance vs. Frequency

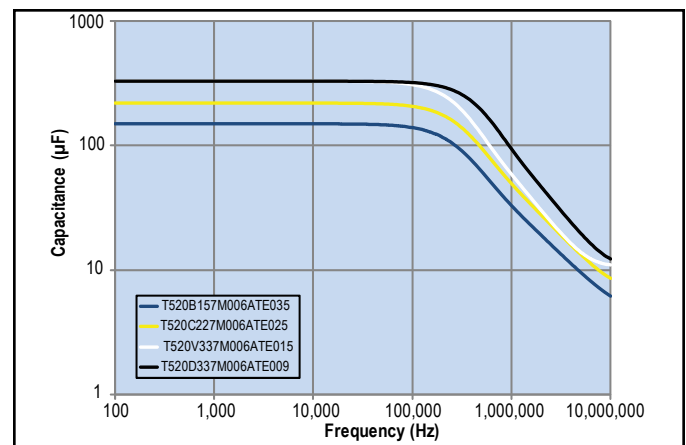

## Dimensions – Millimeters (Inches)

Metric will govern

CATHODE (-) END VIEW

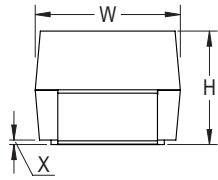

SIDE VIEW

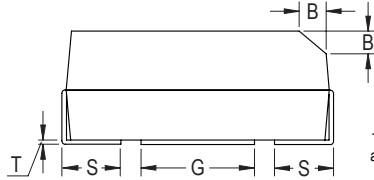

ANODE (+) END VIEW

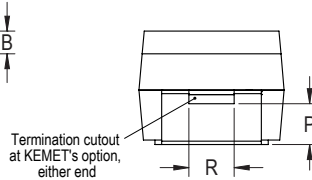

BOTTOM VIEW

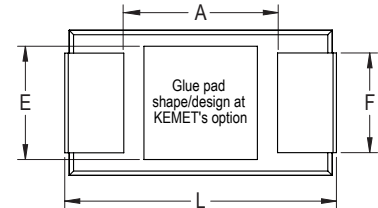

Case Size		Component													
KEMET	EIA	L*	W*	H*	F* ±0.1 ±(0.004)	S* ±0.3 ±(0.012)	B* ±0.15 (Ref) ±0.006	X (Ref)	P (Ref)	R (Ref)	T (Ref)	A (Min)	G (Ref)	E (Ref)	
A	3216-18	3.2 ±0.2 (0.126 ±0.008)	1.6 ±0.2 (0.063 ±0.008)	1.6 ±0.2 (0.063 ±0.008)	1.2 (.047)	0.8 (.031)	0.4 (.016)	0.10 ± 0.10 (.004 ± .004)	0.4 (.016)	0.4 (.016)	0.13 (.005)	0.8 (.31)	1.1 (.043)	1.3 (.051)	
B	3528-21	3.5 ±0.2 (0.138 ±0.008)	2.8 ±0.2 (0.110 ±0.008)	1.9 ±0.1 (0.075 ±0.004)	2.2 (.087)	0.8 (.031)	0.4 (.016)	0.10 ± 0.10 (.004 ± .004)	0.5 (.020)	1.0 (.039)	0.13 (.005)	1.1 (.043)	1.8 (.071)	2.2 (.087)	
C	6032-28	6.0 ±0.3 (0.236 ±0.03)	3.2 ±0.3 (0.126 ±0.012)	2.5 ±0.3 (0.098 ±0.012)	2.2 (.087)	1.3 (.051)	0.5 (.020)	0.10 ± 0.10 (.004 ± .004)	0.9 (.035)	1.0 (.039)	0.13 (.005)	2.5 (.098)	2.8 (.110)	2.4 (.094)	
D	7343-31	7.3 ±0.3 (0.287 ±0.012)	4.3 ±0.3 (0.169 ±0.012)	2.8 ±0.3 (0.110 ±0.012)	2.4 (.094)	1.3 (.051)	0.5 (.020)	0.10 ± 0.10 (.004 ± .004)	0.9 (.035)	1.0 (.039)	0.13 (.005)	3.8 (.150)	3.5 (.138)	3.5 (.138)	
H	7360-20	7.3 ±0.3 (0.287 ±0.012)	6.0 ±0.3 (0.236 ±0.012)	2.0 (0.078) Maximum	4.1 (.161)	1.3 (.051)	n/a	0.10 ± 0.10 (.004 ± .004)	n/a	n/a	0.13 (.005)	3.3 (.130)	3.5 (.138)	3.5 (.138)	
L	6032-19	6.0 ±0.3 (0.236 ±0.012)	3.2 ±0.2 (0.110 ±0.008)	1.9 (0.075)	2.2 (.087)	1.3 (.051)	n/a	0.05 (.002)	n/a	n/a	0.13 (.005)	2.5 (.098)	2.8 (.110)	2.4 (.094)	
M	3528-15	3.5 ±0.2 (0.138 ±0.008)	2.8 ±0.2 (0.110 ±0.008)	1.5 (0.059)	2.2 (.087)	0.8 (.031)	n/a	0.05 (.002)	n/a	n/a	0.13 (.005)	1.1 (.043)	1.8 (.071)	2.2 (.087)	
Q	7343-12	7.3 ±0.3 (0.287 ±0.012)	4.3 ±0.3 (0.169 ±0.012)	1.2 (0.047) Maximum	2.4 (.094)	1.3 (.051)	n/a	0.05 (.002)	n/a	n/a	0.13 (.005)	3.8 (.150)	3.5 (.138)	3.5 (.138)	
T	3528-12	3.5 ±0.2 (0.138 ±0.008)	2.8 ±0.2 (0.110 ±0.008)	1.2 (0.047)	2.2 (.087)	0.8 (.031)	n/a	0.05 (.002)	n/a	n/a	0.13 (.005)	1.1 (.043)	1.8 (.071)	2.2 (.087)	
U	6032-15	6.0 ±0.3 (0.236 ±0.012)	3.2 ±0.2 (0.110 ±0.008)	1.5 (0.059)	2.2 (.087)	1.3 (.051)	n/a	0.05 (.002)	n/a	n/a	0.13 (.005)	2.5 (.098)	2.8 (.110)	2.4 (.094)	
V	7343-20	7.3 ±0.3 (0.287 ±0.012)	4.3 ±0.3 (0.169 ±0.012)	1.9 ±0.1 (0.075 ±0.004)	2.4 (.094)	1.3 (.051)	n/a	0.05 (.002)	n/a	n/a	0.13 (.005)	3.8 (.150)	3.5 (.138)	3.5 (.138)	
W	7343-15	7.3 ±0.3 (0.287 ±0.012)	4.3 ±0.3 (0.169 ±0.012)	1.5 (0.059)	2.4 (.094)	1.3 (.051)	n/a	0.05 (.002)	n/a	n/a	0.13 (.005)	3.8 (.150)	3.5 (.138)	3.5 (.138)	
X	7343-43	7.3 ±0.3 (0.287 ±0.012)	4.3 ±0.3 (0.169 ±0.012)	4.0 ±0.3 (0.157 ±0.012)	2.4 (.094)	1.3 (.051)	0.5 (.020)	0.10 ± 0.10 (.004 ± .004)	1.7 (.067)	1.0 (.039)	0.13 (.005)	3.8 (.150)	3.5 (.138)	3.5 (.138)	
Y	7343-40	7.3 ±0.3 (0.287 ±0.012)	4.3 ±0.3 (0.169 ±0.012)	4.0 (0.157)	2.4 (.094)	1.3 (.051)	0.5 (.020)	0.10 ± 0.10 (.004 ± .004)	1.7 (.067)	1.0 (.039)	0.13 (.005)	3.8 (.150)	3.5 (.138)	3.5 (.138)	

Notes: (Ref) – Dimensions provided for reference only. No dimensions are provided for B, P or R because low profile cases do not have a bevel or a notch.

\* MIL-PRF-55365/8 specified dimensions

**Table 1 – Ratings & Part Number Reference**

Rated Voltage	Rated Cap	Case Code/ Case Size	KEMET Part Number	DC Leakage	DF	ESR	Maximum Allowable Ripple Current	MSL	Maximum Operating Temp
VDC @ 105°C	µF	KEMET/EIA	(See below for part options)	µA @ 20°C Maximum/5 Minutes	% @ 20°C 120 Hz Maximum	mΩ @ 20°C 100 kHz Maximum	mA @ 45°C 100 kHz	Reflow Temp ≤ 260°C	°C
2	470	V/7343-19	T520V477M002A(1)E040	94	10	40	2200	3	105
2.5	47	A/3216-18	T520A476M2R5A(1)E090	12	8	90	1100	3	105
2.5	56	T/3528-12	T520T566M2R5A(1)E040	14	8	40	1600	3	105
2.5	68	A/3216-18	T520A686M2R5A(1)E070	17	8	70	1300	3	105
2.5	68	A/3216-18	T520A686M2R5A(1)E080	17	8	80	1200	3	105
2.5	100	T/3528-12	T520T107M2R5A(1)E040	25	8	40	1600	3	105
2.5	100	T/3528-12	T520T107M2R5A(1)E070	25	8	70	1200	3	105
2.5	100	B/3528-21	T520B107M2R5A(1)E025	25	8	25	2300	3	105
2.5	100	B/3528-21	T520B107M2R5A(1)E035	25	8	35	1900	3	105
2.5	100	B/3528-21	T520B107M2R5A(1)E040	25	8	40	1800	3	105
2.5	100	B/3528-21	T520B107M2R5A(1)E070	25	8	70	1300	3	105
2.5	150	U/6032-15	T520U157M2R5A(1)E055	38	8	55	1600	3	105
2.5	220	B/3528-21	T520B227M2R5A(1)E015	55	8	15	2900	3	105
2.5	220	B/3528-21	T520B227M2R5A(1)E018	55	8	18	2700	3	105
2.5	220	B/3528-21	T520B227M2R5A(1)E021	55	8	21	2500	3	105
2.5	220	B/3528-21	T520B227M2R5A(1)E025	55	8	25	2300	3	105
2.5	220	B/3528-21	T520B227M2R5A(1)E030	55	8	30	2100	3	105
2.5	220	B/3528-21	T520B227M2R5A(1)E035	55	8	35	1900	3	105
2.5	220	B/3528-21	T520B227M2R5A(1)E055	55	8	55	1500	3	105
2.5	220	B/3528-21	T520B227M2R5A(1)E070	55	8	70	1300	3	105
2.5	220	T/3528-12	T520T227M2R5A(1)E070	55	10	70	1225	3	105
2.5	220	U/6032-15	T520U227M2R5A(1)E055	55	8	55	1600	3	105
2.5	220	C/6032-28	T520C227M2R5A(1)E025	55	8	25	2600	3	105
2.5	220	C/6032-28	T520C227M2R5A(1)E045	55	8	45	1900	3	105
2.5	220	W/7343-15	T520W227M2R5A(1)E025	55	10	25	2700	3	105
2.5	220	V/7343-19	T520V227M2R5A(1)E006	55	10	6	5600	3	105
2.5	220	V/7343-19	T520V227M2R5A(1)E007	55	10	7	5200	3	105
2.5	220	V/7343-19	T520V227M2R5A(1)E009	55	10	9	4600	3	105
2.5	220	V/7343-19	T520V227M2R5A(1)E012	55	10	12	3900	3	105
2.5	220	V/7343-19	T520V227M2R5A(1)E015	55	10	15	3500	3	105
2.5	220	V/7343-19	T520V227M2R5A(1)E025	55	10	25	2700	3	105
2.5	220	V/7343-19	T520V227M2R5A(1)E045	55	10	45	2000	3	105
2.5	220	D/7343-31	T520D227M2R5A(1)E007	55	10	7	5700	3	105
2.5	220	D/7343-31	T520D227M2R5A(1)E040	55	10	40	2400	3	105
2.5	330	B/3528-21	T520B337M2R5A(1)E009	83	8	9	3073	3	105
2.5	330	B/3528-21	T520B337M2R5A(1)E012	83	8	12	2700	3	105
2.5	330	B/3528-21	T520B337M2R5A(1)E015	83	8	15	2900	3	105
2.5	330	B/3528-21	T520B337M2R5A(1)E018	83	8	18	2700	3	105
2.5	330	B/3528-21	T520B337M2R5A(1)E035	83	8	35	1900	3	105
2.5	330	B/3528-21	T520B337M2R5A(1)E045	83	8	45	1700	3	105
2.5	330	B/3528-21	T520B337M2R5A(1)E070	83	8	70	1300	3	105
2.5	330	C/6032-28	T520C337M2R5A(1)E015	83	8	15	3300	3	105
2.5	330	C/6032-28	T520C337M2R5A(1)E018	83	8	18	3000	3	105
2.5	330	C/6032-28	T520C337M2R5A(1)E025	83	8	25	2600	3	105
2.5	330	C/6032-28	T520C337M2R5A(1)E045	83	8	45	1900	3	105
2.5	330	L/6032-19	T520L337M2R5A(1)E009	83	8	9	4100	3	105
2.5	330	L/6032-19	T520L337M2R5A(1)E012	83	8	12	3500	3	105
2.5	330	L/6032-19	T520L337M2R5A(1)E025	83	8	25	2400	3	105
VDC @ 105°C	µF	KEMET/EIA	(See below for part options)	µA @ 20°C Maximum/5 Minutes	% @ 20°C 120 Hz Maximum	mΩ @ 20°C 100 kHz Maximum	mA @ 45°C 100 kHz	Reflow Temp ≤ 260°C	°C
Rated Voltage	Rated Cap	Case Code/ Case Size	KEMET Part Number	DC Leakage	DF	ESR	Maximum Allowable Ripple Current	MSL	Maximum Operating Temp

(1) Standard with tin terminations (14th character = T). Tin/lead terminations is also available (14th character = H).

Also available on large (13 inch) reels. Add 7280 to the end of the part number.

Higher voltage ratings and tighter tolerance product including ESR may be substituted within the same size at KEMET's option. Voltage substitutions will be marked with the higher voltage rating. Substitutions can include better than series.

Blue color text denotes "Under Development"

Bold text denotes black epoxy product

**Table 1 – Ratings & Part Number Reference cont'd**

Rated Voltage	Rated Cap	Case Code/ Case Size	KEMET Part Number	DC Leakage	DF	ESR	Maximum Allowable Ripple Current	MSL	Maximum Operating Temp
VDC @ 105°C	µF	KEMET/EIA	(See below for part options)	µA @ 20°C Maximum/5 Minutes	% @ 20°C 120 Hz Maximum	mΩ @ 20°C 100 kHz Maximum	mA @ 45°C 100 kHz	Reflow Temp ≤ 260°C	°C
2.5	330	W/7343-15	T520W337M2R5A(1)E015	83	10	15	3500	3	105
2.5	330	W/7343-15	T520W337M2R5A(1)E025	83	10	25	2700	3	105
2.5	330	W/7343-15	T520W337M2R5A(1)E040	83	10	40	2100	3	105
2.5	330	V/7343-19	T520V337M2R5A(1)E006	83	10	6	5600	3	105
2.5	330	V/7343-19	T520V337M2R5A(1)E007	83	10	7	5200	3	105
2.5	330	V/7343-19	T520V337M2R5A(1)E009	83	10	9	4600	3	105
2.5	330	V/7343-19	T520V337M2R5A(1)E012	83	10	12	3900	3	105
2.5	330	V/7343-19	T520V337M2R5A(1)E015	83	10	15	3500	3	105
2.5	330	V/7343-19	T520V337M2R5A(1)E018	83	10	18	3200	3	105
2.5	330	V/7343-19	T520V337M2R5A(1)E025	83	10	25	2700	3	105
2.5	330	V/7343-19	T520V337M2R5A(1)E040	83	10	40	2200	3	105
2.5	330	D/7343-31	T520D337M2R5A(1)E006	83	10	6	6100	3	105
2.5	330	D/7343-31	T520D337M2R5A(1)E007	83	10	7	5700	3	105
2.5	470	V/7343-19	T520V477M2R5A(1)E006	118	10	6	5600	3	105
2.5	470	V/7343-19	T520V477M2R5A(1)E007	118	10	7	5200	3	105
2.5	470	V/7343-19	T520V477M2R5A(1)E009	118	10	9	4600	3	105
2.5	470	V/7343-19	T520V477M2R5A(1)E012	118	10	12	3900	3	105
2.5	470	V/7343-19	T520V477M2R5A(1)E015	118	10	15	3500	3	105
2.5	470	V/7343-19	T520V477M2R5A(1)E018	118	10	18	3200	3	105
2.5	470	C/6032-28	T520C477M2R5A(1)E025	118	8	25	2600	3	105
2.5	470	C/6032-28	T520C477M2R5A(1)E045	118	8	45	1900	3	105
2.5	470	D/7343-31	T520D477M2R5A(1)E006	118	10	6	6100	3	105
2.5	470	D/7343-31	T520D477M2R5A(1)E007	118	10	7	5700	3	105
2.5	470	D/7343-31	T520D477M2R5A(1)E009	118	10	9	5000	3	105
2.5	680	D/7343-31	T520D687M2R5A(1)E010	170	10	10	4700	3	105
2.5	680	D/7343-31	T520D687M2R5A(1)E015	170	10	15	3900	3	105
2.5	680	D/7343-31	T520D687M2R5A(1)E040	170	10	40	2400	3	105
2.5	680	Y/7343-40	T520Y687M2R5A(1)E025	170	10	25	3100	3	105
2.5	1000	D/7343-31	T520D108M2R5A(1)E015	250	10	15	3900	3	105
2.5	1000	D/7343-31	T520D108M2R5A(1)E030	250	10	30	2700	3	105
2.5	1000	Y/7343-40	T520Y108M2R5A(1)E010	250	10	10	4900	3	105
2.5	1000	Y/7343-40	T520Y108M2R5A(1)E015	250	10	15	4000	3	105
2.5	1000	Y/7343-40	T520Y108M2R5A(1)E025	250	10	25	3100	3	105
2.5	1000	X/7343-43	T520X108M2R5A(1)E010	250	10	10	5000	3	105
3	100	B/3528-21	T520B107M003A(1)E025	30	8	25	2300	3	105
3	100	B/3528-21	T520B107M003A(1)E035	30	8	35	1900	3	105
3	100	B/3528-21	T520B107M003A(1)E040	30	8	40	1800	3	105
3	100	B/3528-21	T520B107M003A(1)E070	30	8	70	1300	3	105
3	150	B/3528-21	T520B157M003A(1)E025	45	8	25	2300	3	105
3	150	B/3528-21	T520B157M003A(1)E035	45	8	35	1900	3	105
3	150	B/3528-21	T520B157M003A(1)E040	45	8	40	1800	3	105
3	150	B/3528-21	T520B157M003A(1)E070	45	8	70	1300	3	105
3	330	V/7343-19	T520V337M003A(1)E009	99	10	9	4600	3	105
3	330	V/7343-19	T520V337M003A(1)E012	99	10	12	3900	3	105
3	330	V/7343-19	T520V337M003A(1)E015	99	10	15	3500	3	105
3	330	V/7343-19	T520V337M003A(1)E025	99	10	25	2700	3	105
3	680	D/7343-31	T520D687M003A(1)E015	204	10	15	3900	3	105
3	680	D/7343-31	T520D687M003A(1)E040	204	10	40	2400	3	105
VDC @ 105°C	µF	KEMET/EIA	(See below for part options)	µA @ 20°C Maximum/5 Minutes	% @ 20°C 120 Hz Maximum	mΩ @ 20°C 100 kHz Maximum	mA @ 45°C 100 kHz	Reflow Temp ≤ 260°C	°C
Rated Voltage	Rated Cap	Case Code/ Case Size	KEMET Part Number	DC Leakage	DF	ESR	Maximum Allowable Ripple Current	MSL	Maximum Operating Temp

(1) Standard with tin terminations (14th character = T). Tin/lead terminations is also available (14th character = H).

Also available on large (13 inch) reels. Add 7280 to the end of the part number.

Higher voltage ratings and tighter tolerance product including ESR may be substituted within the same size at KEMET's option. Voltage substitutions will be marked with the higher voltage rating. Substitutions can include better than series.

**Blue color text denotes "Under Development"**

**Bold text denotes black epoxy product**

**Table 1 – Ratings & Part Number Reference cont'd**

Rated Voltage	Rated Cap	Case Code/ Case Size	KEMET Part Number	DC Leakage	DF	ESR	Maximum Allowable Ripple Current	MSL	Maximum Operating Temp
VDC @ 105°C	µF	KEMET/EIA	(See below for part options)	µA @ 20°C Maximum/5 Minutes	% @ 20°C 120 Hz Maximum	mΩ @ 20°C 100 kHz Maximum	mA @ 45°C 100 kHz	Reflow Temp ≤ 260°C	°C
3	1000	X/7343-43	T520X108M003A(1)E015	300	10	15	4100	3	105
3	1000	X/7343-43	T520X108M003A(1)E030	300	10	30	2900	3	105
4	15	T/3528-12	T520T156M004A(1)E100	6	8	100	1000	3	105
4	33	A/3216-18	T520A336M004A(1)E070	13	8	70	1300	3	105
4	33	A/3216-18	T520A336M004A(1)E080	13	8	80	1200	3	105
4	47	A/3216-18	T520A476M004A(1)E070	19	8	70	1300	3	105
4	47	A/3216-18	T520A476M004A(1)E080	19	8	80	1200	3	105
4	47	T/3528-12	T520T476M004A(1)E070	19	8	70	1200	3	105
4	68	T/3528-12	T520T686M004A(1)E070	27	8	70	1200	3	105
4	68	B/3528-21	T520B686M004A(1)E025	27	8	25	2300	3	105
4	68	B/3528-21	T520B686M004A(1)E035	27	8	35	1900	3	105
4	68	B/3528-21	T520B686M004A(1)E040	27	8	40	1800	3	105
4	68	B/3528-21	T520B686M004A(1)E070	27	8	70	1300	3	105
4	68	U/6032-15	T520U686M004A(1)E055	27	8	55	1600	3	105
4	100	A/3216-18	T520A107M004A(1)E150	40	8	150	900	3	105
4	100	A/3216-18	T520A107M004A(1)E200	40	8	200	700	3	105
4	100	T/3528-12	T520T107M004A(1)E070	40	8	70	1200	3	105
4	100	T/3528-12	T520T107M004A(1)E150	40	8	150	800	3	105
4	100	B/3528-21	T520B107M004A(1)E025	40	8	25	2300	3	105
4	100	B/3528-21	T520B107M004A(1)E035	40	8	35	1900	3	105
4	100	B/3528-21	T520B107M004A(1)E040	40	8	40	1800	3	105
4	100	B/3528-21	T520B107M004A(1)E070	40	8	70	1300	3	105
4	100	U/6032-15	T520U107M004A(1)E055	40	8	55	1600	3	105
4	150	B/3528-21	T520B157M004A(1)E015	60	8	15	2900	3	105
4	150	B/3528-21	T520B157M004A(1)E018	60	8	18	2700	3	105
4	150	B/3528-21	T520B157M004A(1)E025	60	8	25	2300	3	105
4	150	B/3528-21	T520B157M004A(1)E030	60	8	30	2100	3	105
4	150	B/3528-21	T520B157M004A(1)E035	60	8	35	1900	3	105
4	150	B/3528-21	T520B157M004A(1)E040	60	8	40	1800	3	105
4	150	B/3528-21	T520B157M004A(1)E070	60	8	70	1300	3	105
4	150	U/6032-15	T520U157M004A(1)E055	60	8	55	1600	3	105
4	150	C/6032-28	T520C157M004A(1)E015	60	8	15	3300	3	105
4	150	C/6032-28	T520C157M004A(1)E025	60	8	25	2600	3	105
4	150	C/6032-28	T520C157M004A(1)E045	60	8	45	1900	3	105
4	150	C/6032-28	T520C157M004A(1)E100	60	8	100	1300	3	105
4	150	V/7343-19	T520V157M004A(1)E007	60	10	7	5200	3	105
4	150	V/7343-19	T520V157M004A(1)E009	60	10	9	4600	3	105
4	150	V/7343-19	T520V157M004A(1)E012	60	10	12	3900	3	105
4	150	V/7343-19	T520V157M004A(1)E015	60	10	15	3500	3	105
4	150	V/7343-19	T520V157M004A(1)E025	60	10	25	2700	3	105
4	150	D/7343-31	T520D157M004A(1)E007	60	10	7	5700	3	105
4	220	B/3528-21	T520B227M004A(1)E035	88	8	35	1900	3	105
4	220	B/3528-21	T520B227M004A(1)E045	88	8	45	1700	3	105
4	220	B/3528-21	T520B227M004A(1)E070	88	8	70	1300	3	105
4	220	C/6032-28	T520C227M004A(1)E015	88	8	15	3300	3	105
4	220	C/6032-28	T520C227M004A(1)E018	88	8	18	3000	3	105
4	220	C/6032-28	T520C227M004A(1)E025	88	8	25	2600	3	105
4	220	C/6032-28	T520C227M004A(1)E045	88	8	45	1900	3	105
VDC @ 105°C	µF	KEMET/EIA	(See below for part options)	µA @ 20°C Maximum/5 Minutes	% @ 20°C 120 Hz Maximum	mΩ @ 20°C 100 kHz Maximum	mA @ 45°C 100 kHz	Reflow Temp ≤ 260°C	°C
Rated Voltage	Rated Cap	Case Code/ Case Size	KEMET Part Number	DC Leakage	DF	ESR	Maximum Allowable Ripple Current	MSL	Maximum Operating Temp

(1) Standard with tin terminations (14th character = T). Tin/lead terminations is also available (14th character = H).

Also available on large (13 inch) reels. Add 7280 to the end of the part number.

Higher voltage ratings and tighter tolerance product including ESR may be substituted within the same size at KEMET's option. Voltage substitutions will be marked with the higher voltage rating. Substitutions can include better than series.

**Blue color text denotes "Under Development"**

**Bold text denotes black epoxy product**



Table 1 – Ratings &amp; Part Number Reference cont'd

Rated Voltage	Rated Cap	Case Code/ Case Size	KEMET Part Number	DC Leakage	DF	ESR	Maximum Allowable Ripple Current	MSL	Maximum Operating Temp
VDC @ 105°C	µF	KEMET/EIA	(See below for part options)	µA @ 20°C Maximum/5 Minutes	% @ 20°C 120 Hz Maximum	mΩ @ 20°C 100 kHz Maximum	mA @ 45°C 100 kHz	Reflow Temp ≤ 260°C	°C
4	220	C/6032-28	T520C227M004A(1)E055	88	8	55	1700	3	105
4	220	L/6032-19	T520L227M004A(1)E012	88	8	12	3500	3	105
4	220	L/6032-19	T520L227M004A(1)E025	88	8	25	2400	3	105
4	220	W/7343-15	T520W227M004A(1)E025	88	10	25	2700	3	105
4	220	W/7343-15	T520W227M004A(1)E040	88	10	40	2100	3	105
4	220	V/7343-19	T520V227M004A(1)E006	88	10	6	5600	3	105
4	220	V/7343-19	T520V227M004A(1)E007	88	10	7	5200	3	105
4	220	V/7343-19	T520V227M004A(1)E009	88	10	9	4600	3	105
4	220	V/7343-19	T520V227M004A(1)E012	88	10	12	3900	3	105
4	220	V/7343-19	T520V227M004A(1)E015	88	10	15	3500	3	105
4	220	V/7343-19	T520V227M004A(1)E018	88	10	18	3200	3	105
4	220	V/7343-19	T520V227M004A(1)E025	88	10	25	2700	3	105
4	220	V/7343-19	T520V227M004A(1)E040	88	10	40	2200	3	105
4	220	V/7343-19	T520V227M004A(1)E045	88	10	45	2000	3	105
4	220	D/7343-31	T520D227M004A(1)E006	88	10	6	6100	3	105
4	220	D/7343-31	T520D227M004A(1)E007	88	10	7	5700	3	105
4	220	D/7343-31	T520D227M004A(1)E012	88	10	12	4300	3	105
4	220	D/7343-31	T520D227M004A(1)E065	88	10	65	1900	3	105
4	330	C/6032-28	T520C337M004A(1)E025	132	8	25	2600	3	105
4	330	C/6032-28	T520C337M004A(1)E045	132	8	45	1900	3	105
4	330	V/7343-19	T520V337M004A(1)E007	132	10	7	5200	3	105
4	330	V/7343-19	T520V337M004A(1)E009	132	10	9	4600	3	105
4	330	V/7343-19	T520V337M004A(1)E012	132	10	12	3900	3	105
4	330	V/7343-19	T520V337M004A(1)E018	132	10	18	3200	3	105
4	330	V/7343-19	T520V337M004A(1)E025	132	10	25	2700	3	105
4	330	V/7343-19	T520V337M004A(1)E040	132	10	40	2200	3	105
4	330	D/7343-31	T520D337M004A(1)E006	132	10	6	6100	3	105
4	330	D/7343-31	T520D337M004A(1)E007	132	10	7	5700	3	105
4	330	D/7343-31	T520D337M004A(1)E009	132	10	9	5000	3	105
4	330	D/7343-31	T520D337M004A(1)E012	132	10	12	4300	3	105
4	330	D/7343-31	T520D337M004A(1)E015	132	10	15	3900	3	105
4	330	D/7343-31	T520D337M004A(1)E040	132	10	40	2400	3	105
4	330	D/7343-31	T520D337M004A(1)E045	132	10	45	2200	3	105
4	470	D/7343-31	T520D477M004A(1)E010	188	10	10	4700	3	105
4	470	D/7343-31	T520D477M004A(1)E012	188	10	12	4300	3	105
4	470	D/7343-31	T520D477M004A(1)E015	188	10	15	3900	3	105
4	470	D/7343-31	T520D477M004A(1)E018	188	10	18	3500	3	105
4	470	D/7343-31	T520D477M004A(1)E025	188	10	25	3000	3	105
4	470	D/7343-31	T520D477M004A(1)E040	188	10	40	2400	3	105
4	680	D/7343-31	T520D687M004A(1)E012	272	10	12	4300	3	105
4	680	D/7343-31	T520D687M004A(1)E015	272	10	15	3900	3	105
4	680	D/7343-31	T520D687M004A(1)E025	272	10	25	3000	3	105
4	680	Y/7343-40	T520Y687M004A(1)E010	272	10	10	4900	3	105
4	680	Y/7343-40	T520Y687M004A(1)E015	272	10	15	4000	3	105
4	680	Y/7343-40	T520Y687M004A(1)E025	272	10	25	3100	3	105
4	680	X/7343-43	T520X687M004A(1)E010	272	10	10	5000	3	105
4	680	X/7343-43	T520X687M004A(1)E015	272	10	15	4100	3	105
4	680	X/7343-43	T520X687M004A(1)E035	272	10	35	2700	3	105
VDC @ 105°C	µF	KEMET/EIA	(See below for part options)	µA @ 20°C Maximum/5 Minutes	% @ 20°C 120 Hz Maximum	mΩ @ 20°C 100 kHz Maximum	mA @ 45°C 100 kHz	Reflow Temp ≤ 260°C	°C
Rated Voltage	Rated Cap	Case Code/ Case Size	KEMET Part Number	DC Leakage	DF	ESR	Maximum Allowable Ripple Current	MSL	Maximum Operating Temp

(1) Standard with tin terminations (14th character = T). Tin/lead terminations is also available (14th character = H).

Also available on large (13 inch) reels. Add 7280 to the end of the part number.

Higher voltage ratings and tighter tolerance product including ESR may be substituted within the same size at KEMET's option. Voltage substitutions will be marked with the higher voltage rating. Substitutions can include better than series.

**Blue color text denotes "Under Development"**

**Bold text denotes black epoxy product**



**Table 1 – Ratings & Part Number Reference cont'd**

Rated Voltage	Rated Cap	Case Code/ Case Size	KEMET Part Number	DC Leakage	DF	ESR	Maximum Allowable Ripple Current	MSL	Maximum Operating Temp
VDC @ 105°C	µF	KEMET/EIA	(See below for part options)	µA @ 20°C Maximum/5 Minutes	% @ 20°C 120 Hz Maximum	mΩ @ 20°C 100 kHz Maximum	mA @ 45°C 100 kHz	Reflow Temp ≤ 260°C	°C
6.3	15	T/3528-12	T520T156M006A(1)E100	9	8	100	1000	3	105
6.3	22	A/3216-18	T520A226M006A(1)E090	14	8	90	1100	3	105
6.3	22	A/3216-18	T520A226M006A(1)E100	14	8	100	1100	3	105
6.3	22	T/3528-12	T520T226M006A(1)E100	14	8	100	1000	3	105
6.3	33	A/3216-18	T520A336M006A(1)E070	21	8	70	1300	3	105
6.3	33	A/3216-18	T520A336M006A(1)E080	21	8	80	1200	3	105
6.3	33	A/3216-18	T520A336M006A(1)E120	21	8	120	1000	3	105
6.3	33	T/3528-12	T520T336M006A(1)E070	21	8	70	1200	3	105
6.3	33	B/3528-21	T520B336M006A(1)E025	21	8	25	2300	3	105
6.3	33	B/3528-21	T520B336M006A(1)E035	21	8	35	1900	3	105
6.3	33	B/3528-21	T520B336M006A(1)E040	21	8	40	1800	3	105
6.3	33	B/3528-21	T520B336M006A(1)E070	21	8	70	1300	3	105
6.3	33	C/6032-28	T520C336M006A(1)E100	21	8	100	1300	3	105
6.3	47	A/3216-18	T520A476M006A(1)E150	30	8	150	900	3	105
6.3	47	T/3528-12	T520T476M006A(1)E040	30	8	40	1600	3	105
6.3	47	T/3528-12	T520T476M006A(1)E070	30	8	70	1200	3	105
6.3	47	B/3528-21	T520B476M006A(1)E025	30	8	25	2300	3	105
6.3	47	B/3528-21	T520B476M006A(1)E035	30	8	35	1900	3	105
6.3	47	B/3528-21	T520B476M006A(1)E040	30	8	40	1800	3	105
6.3	47	B/3528-21	T520B476M006A(1)E070	30	8	70	1300	3	105
6.3	68	A/3216-18	T520A686M006A(1)E150	43	8	150	900	3	105
6.3	68	T/3528-12	T520T686M006A(1)E070	43	8	70	1200	3	105
6.3	68	T/3528-12	T520T686M006A(1)E150	43	8	150	800	3	105
6.3	68	B/3528-21	T520B686M006A(1)E025	43	8	25	2300	3	105
6.3	68	B/3528-21	T520B686M006A(1)E035	43	8	35	1900	3	105
6.3	68	B/3528-21	T520B686M006A(1)E040	43	8	40	1800	3	105
6.3	68	B/3528-21	T520B686M006A(1)E070	43	8	70	1300	3	105
6.3	68	U/6032-15	T520U686M006A(1)E055	43	8	55	1600	3	105
6.3	68	U/6032-15	T520U686M006A(1)E070	43	8	70	1400	3	105
6.3	68	C/6032-28	T520C686M006A(1)E100	43	8	100	1300	3	105
<b>6.3</b>	<b>100</b>	<b>A/3216-18</b>	<b>T520A107M006ATE070</b>	<b>63</b>	<b>8</b>	<b>70</b>	<b>1035</b>	<b>3</b>	<b>105</b>
6.3	100	T/3528-12	T520T107M006A(1)E070	63	8	70	1200	3	105
6.3	100	B/3528-21	T520B107M006A(1)E015	63	8	15	2900	3	105
6.3	100	B/3528-21	T520B107M006A(1)E018	63	8	18	2700	3	105
6.3	100	B/3528-21	T520B107M006A(1)E025	63	8	25	2300	3	105
6.3	100	B/3528-21	T520B107M006A(1)E035	63	8	35	1900	3	105
6.3	100	B/3528-21	T520B107M006A(1)E040	63	8	40	1800	3	105
6.3	100	B/3528-21	T520B107M006A(1)E045	63	8	45	1700	3	105
6.3	100	B/3528-21	T520B107M006A(1)E070	63	8	70	1300	3	105
6.3	100	U/6032-15	T520U107M006A(1)E055	63	8	55	1600	3	105
6.3	100	W/7343-15	T520W107M006A(1)E040	63	10	40	2100	3	105
6.3	100	V/7343-19	T520V107M006A(1)E009	63	10	9	4600	3	105
6.3	100	V/7343-19	T520V107M006A(1)E012	63	10	12	3900	3	105
6.3	100	V/7343-19	T520V107M006A(1)E015	63	10	15	3500	3	105
6.3	100	V/7343-19	T520V107M006A(1)E045	63	10	45	2000	3	105
6.3	100	C/6032-28	T520C107M006A(1)E025	63	8	25	2600	3	105
6.3	100	C/6032-28	T520C107M006A(1)E045	63	8	45	1900	3	105
6.3	120	B/3528-21	T520B127M006A(1)E035	76	8	35	1900	3	105
VDC @ 105°C	µF	KEMET/EIA	(See below for part options)	µA @ 20°C Maximum/5 Minutes	% @ 20°C 120 Hz Maximum	mΩ @ 20°C 100 kHz Maximum	mA @ 45°C 100 kHz	Reflow Temp ≤ 260°C	°C
Rated Voltage	Rated Cap	Case Code/ Case Size	KEMET Part Number	DC Leakage	DF	ESR	Maximum Allowable Ripple Current	MSL	Maximum Operating Temp

(1) Standard with tin terminations (14th character = T). Tin/lead terminations is also available (14th character = H).

Also available on large (13 inch) reels. Add 7280 to the end of the part number.

Higher voltage ratings and tighter tolerance product including ESR may be substituted within the same size at KEMET's option. Voltage substitutions will be marked with the higher voltage rating. Substitutions can include better than series.

**Blue color text denotes "Under Development"**

**Bold text denotes black epoxy product**

**Table 1 – Ratings & Part Number Reference cont'd**

Rated Voltage	Rated Cap	Case Code/ Case Size	KEMET Part Number	DC Leakage	DF	ESR	Maximum Allowable Ripple Current	MSL	Maximum Operating Temp
VDC @ 105°C	µF	KEMET/EIA	(See below for part options)	µA @ 20°C Maximum/5 Minutes	% @ 20°C 120 Hz Maximum	mΩ @ 20°C 100 kHz Maximum	mA @ 45°C 100 kHz	Reflow Temp ≤ 260°C	°C
6.3	150	M/3528-15	T520M157M006A(1)E070	95	8	70	1300	3	105
6.3	150	M/3528-15	T520M157M006A(1)E150	95	8	150	900	3	105
6.3	150	M/3528-15	T520M157M006A(1)E200	95	8	200	800	3	105
6.3	150	B/3528-21	T520B157M006A(1)E025	95	8	25	2300	3	105
6.3	150	B/3528-21	T520B157M006A(1)E035	95	8	35	1900	3	105
6.3	150	B/3528-21	T520B157M006A(1)E045	95	8	45	1700	3	105
6.3	150	B/3528-21	T520B157M006A(1)E070	95	8	70	1300	3	105
6.3	150	C/6032-28	T520C157M006A(1)E015	95	8	15	3300	3	105
6.3	150	C/6032-28	T520C157M006A(1)E025	95	8	25	2600	3	105
6.3	150	C/6032-28	T520C157M006A(1)E045	95	8	45	1900	3	105
6.3	150	C/6032-28	T520C157M006A(1)E055	95	8	55	1700	3	105
6.3	150	U/6032-15	T520U157M006A(1)E045	95	8	45	1700	3	105
6.3	150	U/6032-15	T520U157M006A(1)E055	95	8	55	1600	3	105
6.3	150	L/6032-19	T520L157M006A(1)E012	95	8	12	3500	3	105
6.3	150	L/6032-19	T520L157M006A(1)E025	95	8	25	2400	3	105
6.3	150	W/7343-15	T520W157M006A(1)E025	95	10	25	2700	3	105
6.3	150	W/7343-15	T520W157M006A(1)E040	95	10	40	2100	3	105
6.3	150	V/7343-19	T520V157M006A(1)E006	95	10	6	5600	3	105
6.3	150	V/7343-19	T520V157M006A(1)E007	95	10	7	5200	3	105
6.3	150	V/7343-19	T520V157M006A(1)E009	95	10	9	4600	3	105
6.3	150	V/7343-19	T520V157M006A(1)E012	95	10	12	3900	3	105
6.3	150	V/7343-19	T520V157M006A(1)E015	95	10	15	3500	3	105
6.3	150	V/7343-19	T520V157M006A(1)E018	95	10	18	3200	3	105
6.3	150	V/7343-19	T520V157M006A(1)E025	95	10	25	2700	3	105
6.3	150	V/7343-19	T520V157M006A(1)E040	95	10	40	2200	3	105
6.3	150	V/7343-19	T520V157M006A(1)E045	95	10	45	2000	3	105
6.3	150	D/7343-31	T520D157M006A(1)E006	95	10	6	6100	3	105
6.3	150	D/7343-31	T520D157M006A(1)E007	95	10	7	5700	3	105
6.3	150	D/7343-31	T520D157M006A(1)E015	95	10	15	3900	3	105
6.3	150	D/7343-31	T520D157M006A(1)E025	95	10	25	3000	3	105
6.3	150	D/7343-31	T520D157M006A(1)E055	95	10	55	2000	3	105
6.3	220	B/3528-21	T520B227M006A(1)E025	139	8	25	2300	3	105
6.3	220	B/3528-21	T520B227M006A(1)E035	139	8	35	1900	3	105
6.3	220	B/3528-21	T520B227M006A(1)E045	139	8	45	1700	3	105
6.3	220	B/3528-21	T520B227M006A(1)E070	139	8	70	1300	3	105
6.3	220	C/6032-28	T520C227M006A(1)E015	139	8	15	3300	3	105
6.3	220	C/6032-28	T520C227M006A(1)E018	139	8	18	3000	3	105
6.3	220	C/6032-28	T520C227M006A(1)E025	139	8	25	2600	3	105
6.3	220	C/6032-28	T520C227M006A(1)E045	139	8	45	1900	3	105
6.3	220	V/7343-19	T520V227M006A(1)E007	139	10	7	5200	3	105
6.3	220	V/7343-19	T520V227M006A(1)E009	139	10	9	4600	3	105
6.3	220	V/7343-19	T520V227M006A(1)E012	139	10	12	3900	3	105
6.3	220	V/7343-19	T520V227M006A(1)E015	139	10	15	3500	3	105
6.3	220	V/7343-19	T520V227M006A(1)E018	139	10	18	3200	3	105
6.3	220	V/7343-19	T520V227M006A(1)E025	139	10	25	2700	3	105
6.3	220	V/7343-19	T520V227M006A(1)E040	139	10	40	2200	3	105
6.3	220	D/7343-31	T520D227M006A(1)E006	139	10	6	6100	3	105
6.3	220	D/7343-31	T520D227M006A(1)E007	139	10	7	5700	3	105
VDC @ 105°C	µF	KEMET/EIA	(See below for part options)	µA @ 20°C Maximum/5 Minutes	% @ 20°C 120 Hz Maximum	mΩ @ 20°C 100 kHz Maximum	mA @ 45°C 100 kHz	Reflow Temp ≤ 260°C	°C
Rated Voltage	Rated Cap	Case Code/ Case Size	KEMET Part Number	DC Leakage	DF	ESR	Maximum Allowable Ripple Current	MSL	Maximum Operating Temp

(1) Standard with tin terminations (14th character = T). Tin/lead terminations is also available (14th character = H).

Also available on large (13 inch) reels. Add 7280 to the end of the part number.

Higher voltage ratings and tighter tolerance product including ESR may be substituted within the same size at KEMET's option. Voltage substitutions will be marked with the higher voltage rating. Substitutions can include better than series.

**Blue color text denotes "Under Development"**

**Bold text denotes black epoxy product**

**Table 1 – Ratings & Part Number Reference cont'd**

Rated Voltage	Rated Cap	Case Code/ Case Size	KEMET Part Number	DC Leakage	DF	ESR	Maximum Allowable Ripple Current	MSL	Maximum Operating Temp
VDC @ 105°C	µF	KEMET/EIA	(See below for part options)	µA @ 20°C Maximum/5 Minutes	% @ 20°C 120 Hz Maximum	mΩ @ 20°C 100 kHz Maximum	mA @ 45°C 100 kHz	Reflow Temp ≤ 260°C	°C
6.3	220	D/7343-31	T520D227M006A(1)E009	139	10	9	5000	3	105
6.3	220	D/7343-31	T520D227M006A(1)E015	139	10	15	3900	3	105
6.3	220	D/7343-31	T520D227M006A(1)E018	139	10	18	3500	3	105
6.3	220	D/7343-31	T520D227M006A(1)E025	139	10	25	3000	3	105
6.3	220	D/7343-31	T520D227M006A(1)E040	139	10	40	2400	3	105
6.3	220	D/7343-31	T520D227M006A(1)E050	139	10	50	2100	3	105
6.3	330	V/7343-19	T520V337M006A(1)E015	208	10	15	3500	3	105
6.3	330	V/7343-19	T520V337M006A(1)E018	208	10	18	3200	3	105
6.3	330	V/7343-19	T520V337M006A(1)E025	208	10	25	2700	3	105
6.3	330	V/7343-19	T520V337M006A(1)E040	208	10	40	2200	3	105
6.3	330	V/7343-19	T520V337M006A(1)E045	208	10	45	2000	3	105
6.3	330	D/7343-31	T520D337M006A(1)E009	208	10	9	5000	3	105
6.3	330	D/7343-31	T520D337M006A(1)E010	208	10	10	4700	3	105
6.3	330	D/7343-31	T520D337M006A(1)E015	208	10	15	3900	3	105
6.3	330	D/7343-31	T520D337M006A(1)E018	208	10	18	3500	3	105
6.3	330	D/7343-31	T520D337M006A(1)E025	208	10	25	3000	3	105
6.3	330	D/7343-31	T520D337M006A(1)E040	208	10	40	2400	3	105
6.3	330	D/7343-31	T520D337M006A(1)E045	208	10	45	2200	3	105
6.3	330	Y/7343-40	T520Y337M006A(1)E010	208	10	10	4900	3	105
6.3	330	Y/7343-40	T520Y337M006A(1)E015	208	10	15	4000	3	105
6.3	330	Y/7343-40	T520Y337M006A(1)E025	208	10	25	3100	3	105
6.3	330	Y/7343-40	T520Y337M006A(1)E040	208	10	40	2500	3	105
6.3	470	W/7343-15	T520W477M006A(1)E055	296	10	55	1800	3	85
6.3	470	W/7343-15	T520W477M006A(1)E035	296	9	35	2300	3	85
6.3	470	V/7343-19	T520V477M006A(1)E055	296	10	55	1800	3	85
6.3	470	V/7343-19	T520V477M006A(1)E035	282	10	35	2300	3	105
6.3	470	Y/7343-40	T520Y477M006A(1)E010	296	10	10	4900	3	105
6.3	470	Y/7343-40	T520Y477M006A(1)E015	296	10	15	4000	3	105
6.3	470	Y/7343-40	T520Y477M006A(1)E018	296	10	18	3700	3	105
6.3	470	Y/7343-40	T520Y477M006A(1)E025	296	10	25	3100	3	105
6.3	470	Y/7343-40	T520Y477M006A(1)E035	296	10	35	2600	3	105
6.3	470	D/7343-31	T520D477M006A(1)E015	296	10	15	3900	3	105
6.3	470	D/7343-31	T520D477M006A(1)E025	296	10	25	3000	3	105
6.3	470	D/7343-31	T520D477M006A(1)E030	296	10	30	2700	3	105
6.3	470	X/7343-43	T520X477M006A(1)E010	296	10	10	5000	3	105
6.3	470	X/7343-43	T520X477M006A(1)E018	296	10	18	3700	3	105
6.3	470	X/7343-43	T520X477M006A(1)E035	296	10	35	2700	3	105
6.3	470	X/7343-43	T520X477M006A(1)E040	296	10	40	2500	3	105
6.3	680	X/7343-43	T520X687M006A(1)E025	428	10	25	3100	3	105
6.3	1000	H/7260-20	T520H108M006A(1)E055	630	20	55	1800	3	85
6.3	1500	H/7260-20	T520H158M006A(1)E055	945	20	55	1800	3	85
8	22	T/3528-12	T520T226M008A(1)E070	18	8	70	1200	3	105
8	33	T/3528-12	T520T336M008A(1)E070	26	8	70	1200	3	105
8	33	T/3528-12	T520T336M008A(1)E080	26	8	80	1100	3	105
8	33	B/3528-21	T520B336M008A(1)E025	26	8	25	2300	3	105
8	33	B/3528-21	T520B336M008A(1)E035	26	8	35	1900	3	105
8	33	B/3528-21	T520B336M008A(1)E040	26	8	40	1800	3	105
8	33	B/3528-21	T520B336M008A(1)E070	26	8	70	1300	3	105
VDC @ 105°C	µF	KEMET/EIA	(See below for part options)	µA @ 20°C Maximum/5 Minutes	% @ 20°C 120 Hz Maximum	mΩ @ 20°C 100 kHz Maximum	mA @ 45°C 100 kHz	Reflow Temp ≤ 260°C	°C
Rated Voltage	Rated Cap	Case Code/ Case Size	KEMET Part Number	DC Leakage	DF	ESR	Maximum Allowable Ripple Current	MSL	Maximum Operating Temp

(1) Standard with tin terminations (14th character = T). Tin/lead terminations is also available (14th character = H).

Also available on large (13 inch) reels. Add 7280 to the end of the part number.

Higher voltage ratings and tighter tolerance product including ESR may be substituted within the same size at KEMET's option. Voltage substitutions will be marked with the higher voltage rating. Substitutions can include better than series.

**Blue color text denotes "Under Development"**

**Bold text denotes black epoxy product**

**Table 1 – Ratings & Part Number Reference cont'd**

Rated Voltage	Rated Cap	Case Code/ Case Size	KEMET Part Number	DC Leakage	DF	ESR	Maximum Allowable Ripple Current	MSL	Maximum Operating Temp
VDC @ 105°C	µF	KEMET/EIA	(See below for part options)	µA @ 20°C Maximum/5 Minutes	% @ 20°C 120 Hz Maximum	mΩ @ 20°C 100 kHz Maximum	mA @ 45°C 100 kHz	Reflow Temp ≤ 260°C	°C
8	33	U/6032-15	T520U336M008A(1)E070	26	8	70	1400	3	105
8	47	B/3528-21	T520B476M008A(1)E035	38	8	35	1900	3	105
8	47	B/3528-21	T520B476M008A(1)E070	38	8	70	1300	3	105
8	82	C/6032-28	T520C826M008A(1)E025	66	8	25	2600	3	105
8	82	C/6032-28	T520C826M008A(1)E045	66	8	45	1900	3	105
8	150	D/7343-31	T520D157M008A(1)E025	120	10	25	3000	3	105
8	150	D/7343-31	T520D157M008A(1)E040	120	10	40	2400	3	105
8	150	D/7343-31	T520D157M008A(1)E055	120	10	55	2000	3	105
8	150	V/7343-19	T520V157M008A(1)E040	120	10	40	2200	3	105
10	10	A/3216-18	T520A106M010A(1)E080	10	8	80	1200	3	105
10	15	A/3216-18	T520A156M010A(1)E080	15	8	80	1200	3	105
10	22	A/3216-18	T520A226M010A(1)E080	22	8	80	1200	3	105
10	33	T/3528-12	T520T336M010A(1)E040	33	8	40	1600	3	105
10	33	T/3528-12	T520T336M010A(1)E070	33	8	70	1200	3	105
10	33	T/3528-12	T520T336M010A(1)E080	33	8	80	1100	3	105
10	33	B/3528-21	T520B336M010A(1)E025	33	8	25	2300	3	105
10	33	B/3528-21	T520B336M010A(1)E035	33	8	35	1900	3	105
10	33	B/3528-21	T520B336M010A(1)E040	33	8	40	1800	3	105
10	33	B/3528-21	T520B336M010A(1)E070	33	8	70	1300	3	105
10	33	U/6032-15	T520U336M010A(1)E070	33	8	70	1400	3	105
10	47	B/3528-21	T520B476M010A(1)E035	47	8	35	1900	3	105
10	47	B/3528-21	T520B476M010A(1)E070	47	8	70	1300	3	105
10	47	U/6032-15	T520U476M010A(1)E055	47	8	55	1600	3	105
10	47	C/6032-28	T520C476M010A(1)E100	47	8	100	1300	3	105
10	68	U/6032-15	T520U686M010A(1)E055	68	8	55	1600	3	105
10	68	W/7343-15	T520W686M010A(1)E025	68	10	25	2700	3	105
10	68	W/7343-15	T520W686M010A(1)E040	68	10	40	2100	3	105
10	68	C/6032-28	T520C686M010A(1)E045	68	8	45	1900	3	105
10	68	V/7343-19	T520V686M010A(1)E025	68	10	25	2700	3	105
10	68	V/7343-19	T520V686M010A(1)E040	68	10	40	2200	3	105
10	68	V/7343-19	T520V686M010A(1)E045	68	10	45	2000	3	105
10	68	V/7343-19	T520V686M010A(1)E060	68	10	60	1800	3	105
10	68	V/7343-19	T520V686M010A(1)E100	68	10	100	1400	3	105
10	68	D/7343-31	T520D686M010A(1)E100	68	10	100	1500	3	105
10	100	C/6032-28	T520C107M010A(1)E025	100	8	25	2600	3	105
10	100	C/6032-28	T520C107M010A(1)E045	100	8	45	1900	3	105
10	100	L/6032-19	T520L107M010A(1)E025	100	8	25	2400	3	105
10	100	W/7343-15	T520W107M010A(1)E040	100	10	40	2100	3	105
10	100	V/7343-19	T520V107M010A(1)E018	100	10	18	3200	3	105
10	100	V/7343-19	T520V107M010A(1)E025	100	10	25	2700	3	105
10	100	V/7343-19	T520V107M010A(1)E045	100	10	45	2000	3	105
10	100	V/7343-19	T520V107M010A(1)E050	100	10	50	1900	3	105
10	100	D/7343-31	T520D107M010A(1)E018	100	10	18	3500	3	105
10	100	D/7343-31	T520D107M010A(1)E055	100	10	55	2000	3	105
10	100	D/7343-31	T520D107M010A(1)E080	100	10	80	1700	3	105
10	150	C/6032-28	T520C157M010A(1)E055	150	8	55	1700	3	105
10	150	V/7343-19	T520V157M010A(1)E018	150	10	18	3200	3	105
10	150	V/7343-19	T520V157M010A(1)E025	150	10	25	2700	3	105
VDC @ 105°C	µF	KEMET/EIA	(See below for part options)	µA @ 20°C Maximum/5 Minutes	% @ 20°C 120 Hz Maximum	mΩ @ 20°C 100 kHz Maximum	mA @ 45°C 100 kHz	Reflow Temp ≤ 260°C	°C
Rated Voltage	Rated Cap	Case Code/ Case Size	KEMET Part Number	DC Leakage	DF	ESR	Maximum Allowable Ripple Current	MSL	Maximum Operating Temp

(1) Standard with tin terminations (14th character = T). Tin/lead terminations is also available (14th character = H).

Also available on large (13 inch) reels. Add 7280 to the end of the part number.

Higher voltage ratings and tighter tolerance product including ESR may be substituted within the same size at KEMET's option. Voltage substitutions will be marked with the higher voltage rating. Substitutions can include better than series.

**Blue color text denotes "Under Development"**

**Bold text denotes black epoxy product**

Table 1 – Ratings &amp; Part Number Reference cont'd

Rated Voltage	Rated Cap	Case Code/ Case Size	KEMET Part Number	DC Leakage	DF	ESR	Maximum Allowable Ripple Current	MSL	Maximum Operating Temp
VDC @ 105°C	µF	KEMET/EIA	(See below for part options)	µA @ 20°C Maximum/5 Minutes	% @ 20°C 120 Hz Maximum	mΩ @ 20°C 100 kHz Maximum	mA @ 45°C 100 kHz	Reflow Temp ≤ 260°C	°C
10	150	V/7343-19	T520V157M010A(1)E040	150	10	40	2200	3	105
10	150	D/7343-31	T520D157M010A(1)E015	150	10	15	3900	3	105
10	150	D/7343-31	T520D157M010A(1)E018	150	10	18	3500	3	105
10	150	D/7343-31	T520D157M010A(1)E025	150	10	25	3000	3	105
10	150	D/7343-31	T520D157M010A(1)E040	150	10	40	2400	3	105
10	150	D/7343-31	T520D157M010A(1)E055	150	10	55	2000	3	105
10	150	Y/7343-40	T520Y157M010A(1)E015	150	10	15	4000	3	105
10	150	Y/7343-40	T520Y157M010A(1)E018	150	10	18	3700	3	105
10	150	Y/7343-40	T520Y157M010A(1)E025	150	10	25	3100	3	105
10	220	V/7343-19	T520V227M010A(1)E045	220	10	45	2000	3	105
10	220	V/7343-19	T520V227M010A(1)E025	220	10	25	2700	3	105
10	220	D/7343-31	T520D227M010A(1)E018	220	10	18	3500	3	105
10	220	D/7343-31	T520D227M010A(1)E025	220	10	25	3000	3	105
10	220	D/7343-31	T520D227M010A(1)E040	220	10	40	2400	3	105
10	220	Y/7343-40	T520Y227M010A(1)E040	220	10	40	2500	3	105
10	330	Y/7343-40	T520Y337M010A(1)E015	330	10	15	4000	3	105
10	330	Y/7343-40	T520Y337M010A(1)E035	330	10	35	2600	3	105
10	330	X/7343-43	T520X337M010A(1)E010	330	10	10	5000	3	105
10	330	X/7343-43	T520X337M010A(1)E025	330	10	25	3100	3	105
10	330	X/7343-43	T520X337M010A(1)E040	330	10	40	2500	3	105
11	47	Q/7343-12	T520Q476M011A(1)E040	52	10	40	4500	3	105
12.5	10	T/3528-12	T520T106M12RA(1)E150	13	8	150	800	3	105
12.5	15	T/3528-12	T520T156M12RA(1)E080	19	8	80	1100	3	105
16	10	B/3528-21	T520B106M016A(1)E100	16	8	100	1100	3	105
16	22	C/6032-28	T520C226M016A(1)E080	35	8	80	1400	3	105
16	33	W/7343-15	T520W336M016A(1)E045	53	10	45	2000	3	105
16	33	V/7343-19	T520V336M016A(1)E045	53	10	45	2000	3	105
16	33	V/7343-19	T520V336M016A(1)E060	53	10	60	1800	3	105
16	33	V/7343-19	T520V336M016A(1)E070	53	10	70	1600	3	105
16	47	W/7343-15	T520W476M016A(1)E045	75	10	45	2000	3	105
16	47	V/7343-19	T520V476M016A(1)E045	75	10	45	2000	3	105
16	47	V/7343-19	T520V476M016A(1)E070	75	10	70	1600	3	105
16	47	D/7343-31	T520D476M016A(1)E035	75	10	35	2500	3	105
16	47	D/7343-31	T520D476M016A(1)E070	75	10	70	1800	3	105
16	68	D/7343-31	T520D686M016A(1)E050	109	10	50	2100	3	105
16	150	X/7343-43	T520X157M016A(1)E040	240	10	40	2500	3	105
20	22	V/7343-19	T520V226M020A(1)E040	44	10	40	2200	3	105
20	22	V/7343-19	T520V226M020A(1)E045	44	10	45	2000	3	105
20	22	V/7343-19	T520V226M020A(1)E090	44	10	90	1400	3	105
25	15	V/7343-19	T520V156M025A(1)E090	38	10	90	1400	3	105
25	15	D/7343-31	T520D156M025A(1)E060	38	10	60	1900	3	105
25	15	D/7343-31	T520D156M025A(1)E080	38	10	80	1700	3	105
VDC @ 105°C	µF	KEMET/EIA	(See below for part options)	µA @ 20°C Maximum/5 Minutes	% @ 20°C 120 Hz Maximum	mΩ @ 20°C 100 kHz Maximum	mA @ 45°C 100 kHz	Reflow Temp ≤ 260°C	°C
Rated Voltage	Rated Cap	Case Code/ Case Size	KEMET Part Number	DC Leakage	DF	ESR	Maximum Allowable Ripple Current	MSL	Maximum Operating Temp

(1) Standard with tin terminations (14th character = T). Tin/lead terminations is also available (14th character = H).

Also available on large (13 inch) reels. Add 7280 to the end of the part number.

Higher voltage ratings and tighter tolerance product including ESR may be substituted within the same size at KEMET's option. Voltage substitutions will be marked with the higher voltage rating. Substitutions can include better than series.

**Blue color text denotes "Under Development"**

**Bold text denotes black epoxy product**

## Derating Guidelines

Voltage Rating	Maximum Recommended Steady State Voltage	Maximum Recommended Transient Voltage (1 ms – 1 μs)
-55°C to 105°C		
$2. V \leq V_R \leq 10 V$	90% of $V_R$	$V_R$
$12.5 V \leq V_R \leq 25 V$	80% of $V_R$	$V_R$

$V_R$  = Rated Voltage

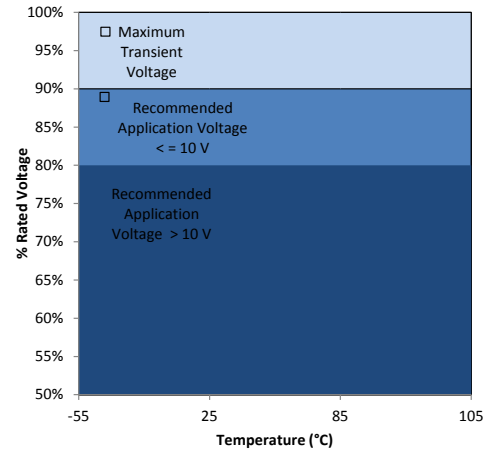

## Ripple Current/Ripple Voltage

Permissible AC ripple voltage and current are related to equivalent series resistance (ESR) and the power dissipation capabilities of the device. Permissible AC ripple voltage which may be applied is limited by two criteria:

1. The positive peak AC voltage plus the DC bias voltage, if any, must not exceed the DC voltage rating of the capacitor.
2. The negative peak AC voltage in combination with bias voltage, if any, must not exceed the allowable limits specified for reverse voltage. See the Reverse Voltage section for allowable limits.

The maximum power dissipation by case size can be determined using the table at right. The maximum power dissipation rating stated in the table must be reduced with increasing environmental operating temperatures. Refer to the table below for temperature compensation requirements.

Temperature Compensation Multipliers for Maximum Ripple Current		
$T \leq 45^\circ C$	$45^\circ C < T \leq 85^\circ C$	$85^\circ C < T \leq 125^\circ C$
1.00	0.70	0.25

$T$  = Environmental Temperature

Using the P max of the device, the maximum allowable rms ripple current or voltage may be determined.

$$I(max) = \sqrt{P_{max}/R}$$

$$E(max) = Z \sqrt{P_{max}/R}$$

$I$  = rms ripple current (amperes)

$E$  = rms ripple voltage (volts)

$P_{max}$  = maximum power dissipation(watts)

$R$  = ESR at specified frequency (ohms)

$Z$  = Impedance at specified frequency (ohms)

KEMET Series and Case Code	EIA Case Code	Maximum Power Dissipation (P max) mWatts @ 45°C with +30°C Rise
T520T	3528-12	105
T520M	3528-15	120
T520A	3216-18	112
T520B	3528-21	127
T520U	6032-15	135
T520L	6032-19	150
T520C	6032-28	165
T520W	7343-15	180
T520V / T522V	7343-19	187
T520Q	7343-12	170
T520D	7343-31	225
T520Y/T522Y	7343-40	241
T520X	7343-43	247
T520H	7360-20	187

The maximum power dissipation rating must be reduced with increasing environmental operating temperatures. Refer to the Temperature Compensation Multiplier table for details.



## Reverse Voltage

Polymer tantalum capacitors are polar devices and may be permanently damaged or destroyed if connected in the wrong polarity. These devices will withstand a small degree of transient voltage reversal for short periods as shown in the below table.

Temperature	Permissible Transient Reverse Voltage
25°C	15% of Rated Voltage
55°C	10% of Rated Voltage
85°C	5% of Rated Voltage
105°C	3% of Rated Voltage
125°C*	1% of Rated Voltage

\*For series rated to 125°C

### Table 2 – Land Dimensions/Courtyard

KEMET	Metric Size Code	Density Level A: Maximum (Most) Land Protrusion (mm)					Density Level B: Median (Nominal) Land Protrusion (mm)					Density Level C: Minimum (Least) Land Protrusion (mm)				
		Case	EIA	W	L	S	V1	V2	W	L	S	V1	V2	W	L	S
A	3216-18	1.35	2.20	0.62	6.02	2.80	1.23	1.80	0.82	4.92	2.30	1.13	1.42	0.98	4.06	2.04
B	3528-21	2.35	2.21	0.92	6.32	4.00	2.23	1.80	1.12	5.22	3.50	2.13	1.42	1.28	4.36	3.24
C	6032-25	2.35	2.77	2.37	8.92	4.50	2.23	2.37	2.57	7.82	4.00	2.13	1.99	2.73	6.96	3.74
D	7343-31	2.55	2.77	3.67	10.22	5.60	2.43	2.37	3.87	9.12	5.10	2.33	1.99	4.03	8.26	4.84
L	6032-19	2.35	2.77	2.37	8.92	4.50	2.23	2.37	2.57	7.82	4.00	2.13	1.99	2.73	6.96	3.74
M	3528-15	2.35	2.20	0.92	6.32	4.00	2.23	1.80	1.12	5.22	3.50	2.13	1.42	1.28	4.36	3.24
H	7360-20	4.25	2.77	3.67	10.22	7.30	4.13	2.37	3.87	9.12	6.80	4.03	1.99	4.03	8.26	6.54
Q	7343-12	2.55	2.77	3.67	10.22	5.60	2.43	2.37	3.87	9.12	5.10	2.33	1.99	4.03	8.26	4.84
T	3528-12	2.35	2.20	0.92	6.32	4.00	2.23	1.80	1.12	5.22	3.50	2.13	1.42	1.28	4.36	3.24
U	6032-15	2.35	2.77	2.37	8.92	4.50	2.23	2.37	2.57	7.82	4.00	2.13	1.99	2.73	6.96	3.74
V	7343-20	2.55	2.77	3.67	10.22	5.60	2.43	2.37	3.87	9.12	5.10	2.33	1.99	4.03	8.26	4.84
W	7343-15	2.55	2.77	3.67	10.22	5.60	2.43	2.37	3.87	9.12	5.10	2.33	1.99	4.03	8.26	4.84
X <sup>1</sup>	7343-43	2.55	2.77	3.67	10.22	5.60	2.43	2.37	3.87	9.12	5.10	2.33	1.99	4.03	8.26	4.84
Y <sup>1</sup>	7343-40	2.55	2.77	3.67	10.22	5.60	2.43	2.37	3.87	9.12	5.10	2.33	1.99	4.03	8.26	4.84

**Density Level A:** For low-density product applications. Recommended for wave solder applications and provides a wider process window for reflow solder processes.

**Density Level B:** For products with a moderate level of component density. Provides a robust solder attachment condition for reflow solder processes.

**Density Level C:** For high component density product applications. Before adapting the minimum land pattern variations the user should perform qualification testing based on the conditions outlined in IPC standard 7351 (IPC-7351).

<sup>1</sup> Height of these chips may create problems in wave soldering.

<sup>2</sup> Land pattern geometry is too small for silkscreen outline.

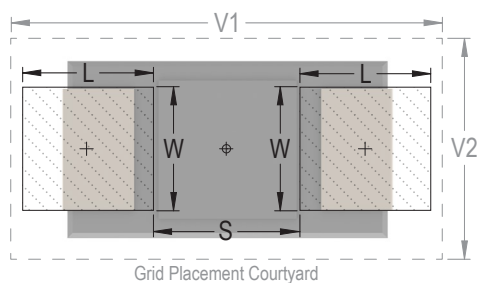



## Soldering Process

KEMET’s families of surface mount capacitors are compatible with wave (single or dual), convection, IR, or vapor phase reflow techniques. Preheating of these components is recommended to avoid extreme thermal stress. KEMET’s recommended profile conditions for convection and IR reflow reflect the profile conditions of the IPC/J–STD–020D standard for moisture sensitivity testing. The devices can safely withstand a maximum of three reflow passes at these conditions.

Please note that although the X/7343–43 case size can withstand wave soldering, the tall profile (4.3 mm maximum) dictates care in wave process development.

Hand soldering should be performed with care due to the difficulty in process control. If performed, care should be taken to avoid contact of the soldering iron to the molded case. The iron should be used to heat the solder pad, applying solder between the pad and the termination, until reflow occurs. Once reflow occurs, the iron should be removed immediately. “Wiping” the edges of a chip and heating the top surface is not recommended.

During typical reflow operations, a slight darkening of the gold-colored epoxy may be observed. This slight darkening is normal and not harmful to the product. Marking permanency is not affected by this change.

Profile Feature	SnPb Assembly	Pb-Free Assembly
Preheat/Soak		
Temperature Minimum ( $T_{Smin}$ )	100°C	150°C
Temperature Maximum ( $T_{Smax}$ )	150°C	200°C
Time ( $t_s$ ) from $T_{Smin}$ to $T_{Smax}$	60 – 120 seconds	60 – 120 seconds
Ramp-up Rate ( $T_L$ to $T_p$ )	3°C/seconds maximum	3°C/seconds maximum
Liquidous Temperature ( $T_L$ )	183°C	217°C
Time Above Liquidous ( $t_L$ )	60 – 150 seconds	60 – 150 seconds
Peak Temperature ( $T_p$ )	220°C* 235°C**	250°C* 260°C**
Time within 5°C of Maximum Peak Temperature ( $t_p$ )	20 seconds maximum	30 seconds maximum
Ramp-down Rate ( $T_p$ to $T_L$ )	6°C/seconds maximum	6°C/seconds maximum
Time 25°C to Peak Temperature	6 minutes maximum	8 minutes maximum

Note: All temperatures refer to the center of the package, measured on the package body surface that is facing up during assembly reflow.

\*Case Size D, E, P, Y, and X

\*\*Case Size A, B, C, H, I, K, M, R, S, T, U, V, W, and Z

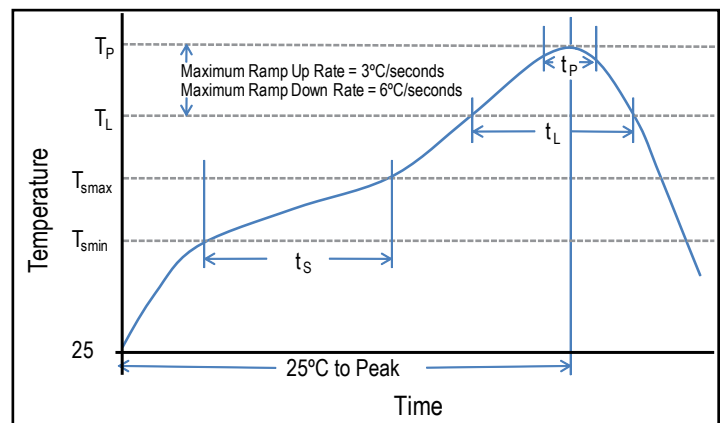

## Storage

All KO-CAP series are shipped in moisture barrier bags with a desiccant and moisture indicator card. These series are classified as MSL3 (Moisture Sensitivity Level 3). Product contained within the moisture barrier bags should be stored in normal working environments with temperatures not to exceed 40°C and humidity not in excess of 60% RH.

## Construction

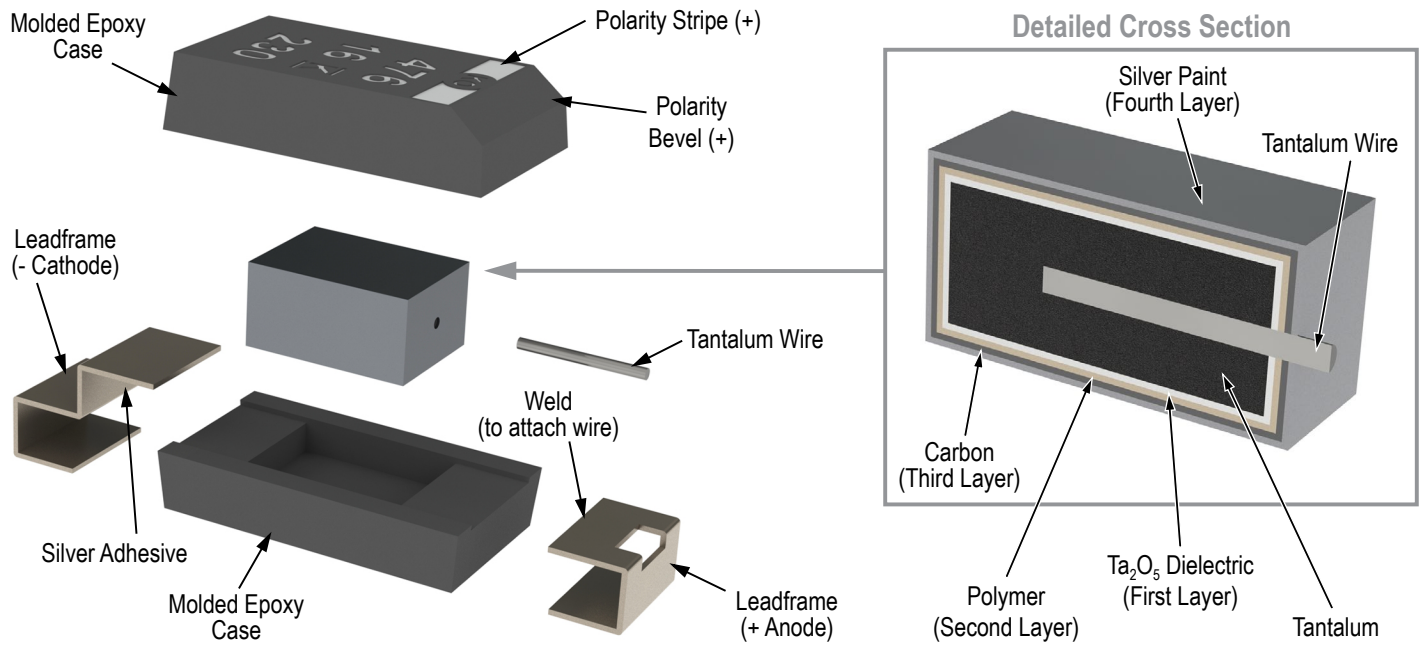

## Capacitor Marking

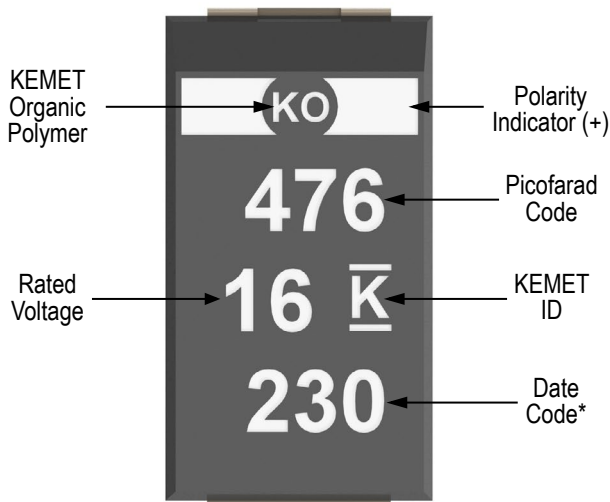

\* 230 = 30<sup>th</sup> week of 2012

Date Code *	
1 <sup>st</sup> digit = Last number of Year	9 = 2009 0 = 2010 1 = 2011 2 = 2012 3 = 2013 4 = 2014
2 <sup>nd</sup> and 3 <sup>rd</sup> digit = Week of the Year	01 = 1 <sup>st</sup> week of the Year to 52 = 52 <sup>nd</sup> week of the Year

## Capacitor Marking cont'd

### C, D, X Case Sizes

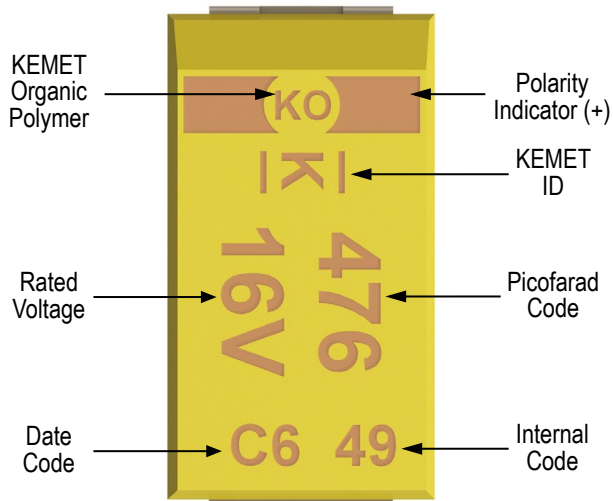

Date Code*		
Year	Month	
X = 2009	1 = Jan	7 = Jul
A = 2010	2 = Feb	8 = Aug
B = 2011	3 = Mar	9 = Sept
C = 2012	4 = Apr	O = Oct
D = 2013	5 = May	N = Nov
E = 2014	6 = Jun	D = Dec

### Black Epoxy

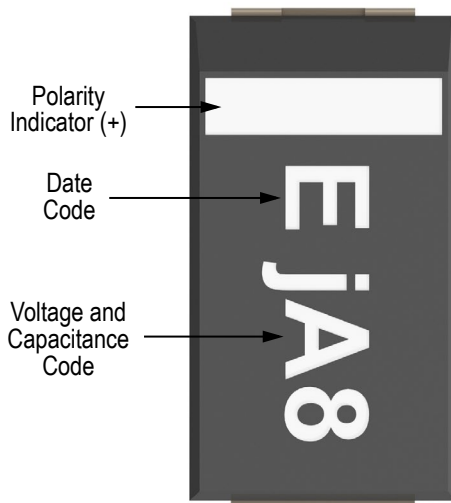

Date Code *												
	Jan	Feb	Mar	Apr	May	Jun	Jul	Aug	Sep	Oct	Nov	Dec
2013	A	B	C	D	E	F	G	H	J	K	L	M
2014	N	P	Q	R	S	T	U	V	W	X	Y	Z
2015	a	b	c	d	e	f	g	h	j	k	l	m
2016	n	p	q	r	s	t	u	v	w	x	y	z

Code	e	g	j	A
Rated Voltage	2.5 V	4 V	6 V	10 V

Code	J7	N7	S7	W7	A8	N8
Capacitance	22	33	47	68	100	330

## Tape & Reel Packaging Information

KEMET's molded tantalum and aluminum chip capacitor families are packaged in 8 and 12 mm plastic tape on 7" and 13" reels in accordance with *EIA Standard 481: Embossed Carrier Taping of Surface Mount Components for Automatic Handling*. This packaging system is compatible with all tape-fed automatic pick-and-place systems.

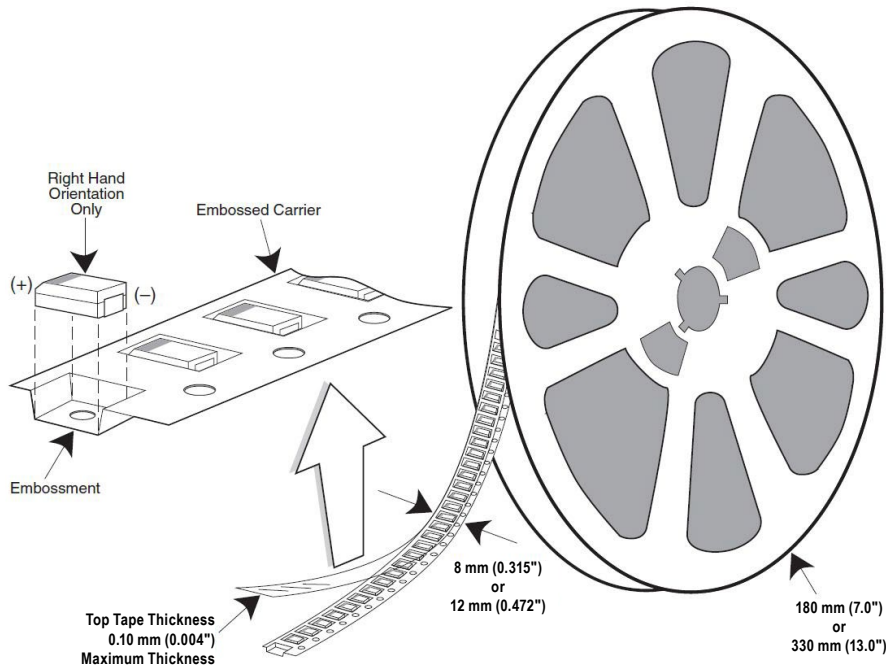

**Table 3 – Packaging Quantity**

Case Code		Tape Width (mm)	7" Reel*	13" Reel*
KEMET	EIA			
R	2012-12	8	2,500	10,000
I	3216-10	8	3,000	12,000
S	3216-12	8	2,500	10,000
T	3528-12	8	2,500	10,000
M	3528-15	8	2,000	8,000
U	6032-15	12	1,000	5,000
L	6032-19	12	1,000	5,000
W	7343-15	12	1,000	3,000
Z	7343-17	12	1,000	3,000
Q	7343-12	12	1,000	3,000
V	7343-19	12	1,000	3,000
A	3216-18	8	2,000	9,000
B	3528-21	8	2,000	8,000
C	6032-28	12	500	3,000
D	7343-31	12	500	2,500
Y	7343-40	12	500	2,000
X	7343-43	12	500	2,000
E/T428P	7360-38	12	500	2,000
H	7360-20	12	1,000	3,000

\* No C-Spec required for 7" reel packaging. C-7280 required for 13" reel packaging.

\* A case with black epoxy only available in 7" reel

**Figure 1 – Embossed (Plastic) Carrier Tape Dimensions**

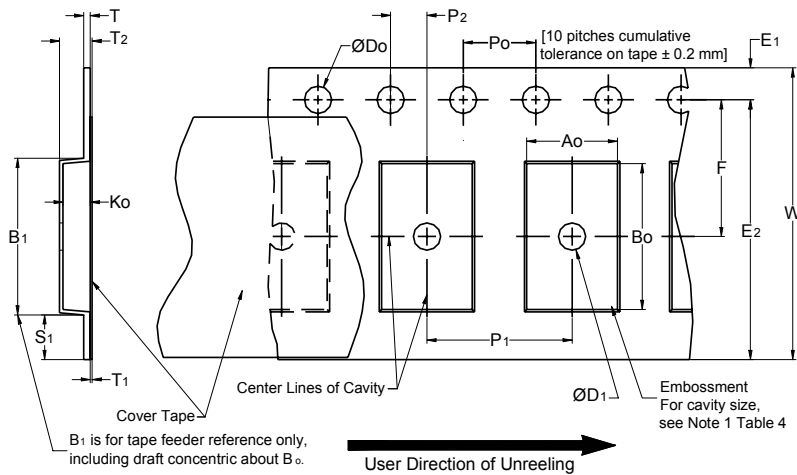

**Table 4 – Embossed (Plastic) Carrier Tape Dimensions**

Metric will govern

Constant Dimensions — Millimeters (Inches)											
Tape Size	D <sub>0</sub>	D <sub>1</sub> Minimum Note 1	E <sub>1</sub>	P <sub>0</sub>	P <sub>2</sub>	R Reference Note 2	S <sub>1</sub> Minimum Note 3	T Maximum	T <sub>1</sub> Maximum		
8 mm	1.5 +0.10/-0.0 (0.059 +0.004/-0.0)	1.0 (0.039)	1.75 ±0.10 (0.069 ±0.004)	4.0 ±0.10 (0.157 ±0.004)	2.0 ±0.05 (0.079 ±0.002)	25.0 (0.984)	0.600 (0.024)	0.600 (0.024)	0.100 (0.004)		
12 mm		1.5 (0.059)								2.0 ±0.1 (0.079 ±0.059)	30 (1.181)
16 mm											
Variable Dimensions — Millimeters (Inches)											
Tape Size	Pitch	B <sub>1</sub> Maximum Note 4	E <sub>2</sub> Minimum	F	P <sub>1</sub>	T <sub>2</sub> Maximum	W Maximum	A <sub>0</sub> , B <sub>0</sub> & K <sub>0</sub>			
8 mm	Single (4 mm)	4.35 (0.171)	6.25 (0.246)	3.5 ±0.05 (0.138 ±0.002)	2.0 ±0.05 or 4.0 ±0.10 (0.079 ±0.002 or 0.157 ±0.004)	2.5 (0.098)	8.3 (0.327)	Note 5			
12 mm	Single (4 mm) & Double (8 mm)	8.2 (0.323)	10.25 (0.404)	5.5 ±0.05 (0.217 ±0.002)	2.0 ±0.05 (0.079 ±0.002) or 4.0 ±0.10 (0.157 ±0.004) or 8.0 ±0.10 (0.315 ±0.004)	4.6 (0.181)	12.3 (0.484)				
16 mm	Triple (12 mm)	12.1 (0.476)	14.25 (0.561)	7.5 ±0.10 (0.295 ±0.004)	4.0 ±0.10 (0.157 ±0.004) to 12.0 ±0.10 (0.472 ±0.004)	8.0 (0.315)	16.3 (0.642)				

1. The embossment hole location shall be measured from the sprocket hole controlling the location of the embossment. Dimensions of embossment location and hole location shall be applied independent of each other.
2. The tape, with or without components, shall pass around R without damage (see Figure 4).
3. If S<sub>1</sub> < 1.0 mm, there may not be enough area for cover tape to be properly applied (see EIA Standard 481–D, paragraph 4.3, section b).
4. B<sub>1</sub> dimension is a reference dimension for tape feeder clearance only.
5. The cavity defined by A<sub>0</sub>, B<sub>0</sub> and K<sub>0</sub> shall surround the component with sufficient clearance that:
  - (a) the component does not protrude above the top surface of the carrier tape.
  - (b) the component can be removed from the cavity in a vertical direction without mechanical restriction, after the top cover tape has been removed.
  - (c) rotation of the component is limited to 20° maximum for 8 and 12 mm tapes and 10° maximum for 16 mm tapes (see Figure 2).
  - (d) lateral movement of the component is restricted to 0.5 mm maximum for 8 mm and 12 mm wide tape and to 1.0 mm maximum for 16 mm tape (see Figure 3).
  - (e) see Addendum in EIA Standard 481–D for standards relating to more precise taping requirements.

## Packaging Information Performance Notes

- 1. Cover Tape Break Force:** 1.0 Kg minimum.
- 2. Cover Tape Peel Strength:** The total peel strength of the cover tape from the carrier tape shall be:

Tape Width	Peel Strength
8 mm	0.1 to 1.0 Newton (10 to 100 gf)
12 and 16 mm	0.1 to 1.3 Newton (10 to 130 gf)

The direction of the pull shall be opposite the direction of the carrier tape travel. The pull angle of the carrier tape shall be 165° to 180° from the plane of the carrier tape. During peeling, the carrier and/or cover tape shall be pulled at a velocity of 300 ±10 mm/minute.

- 3. Labeling:** Bar code labeling (standard or custom) shall be on the side of the reel opposite the sprocket holes. Refer to EIA Standards 556 and 624.

### Figure 2 – Maximum Component Rotation

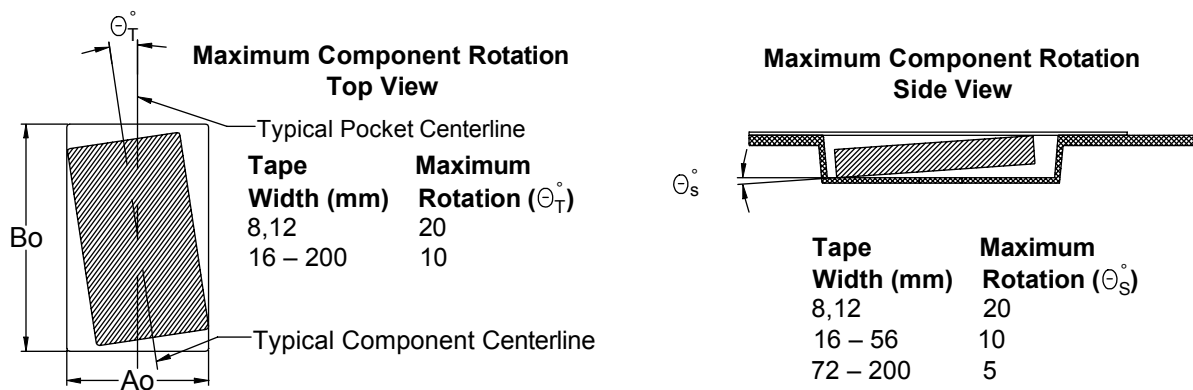

### Figure 3 – Maximum Lateral Movement

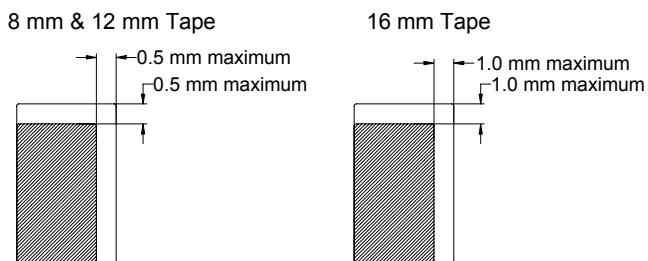

### Figure 4 – Bending Radius

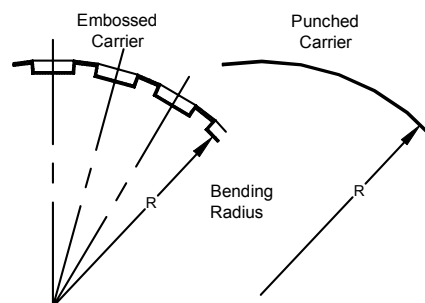

**Figure 5 – Reel Dimensions**

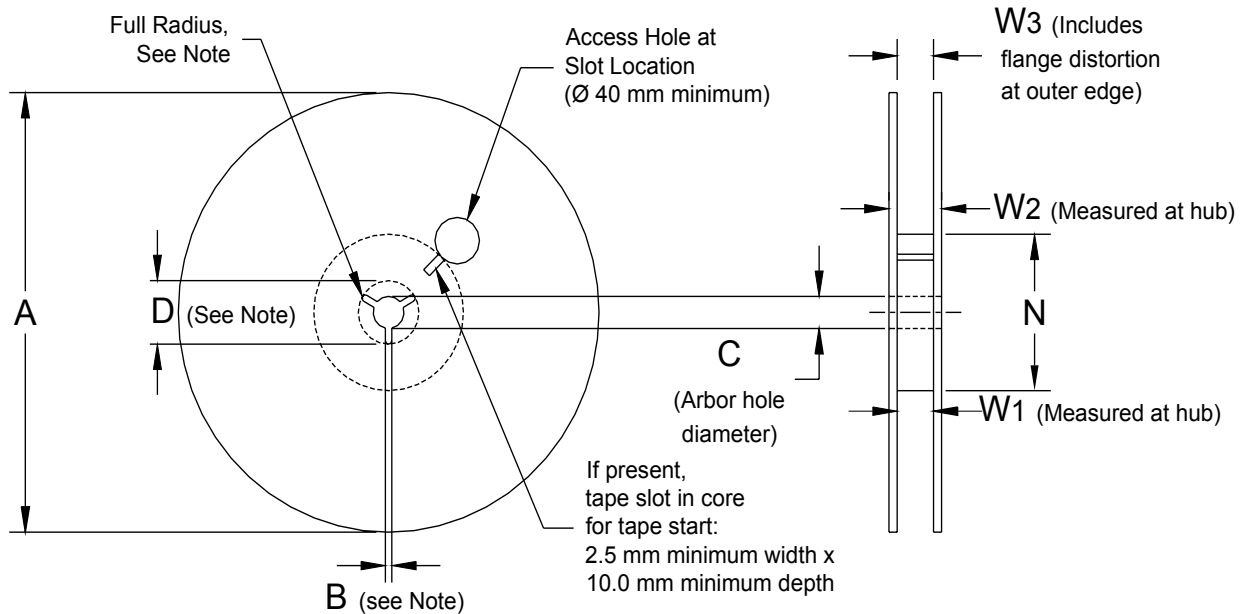

**Table 5 – Reel Dimensions**

Metric will govern

Constant Dimensions — Millimeters (Inches)				
Tape Size	A	B Minimum	C	D Minimum
8 mm	178 ±0.20 (7.008 ±0.008) or 330 ±0.20 (13.000 ±0.008)	1.5 (0.059)	13.0 +0.5/-0.2 (0.521 +0.02/-0.008)	20.2 (0.795)
12 mm				
16 mm				
Variable Dimensions — Millimeters (Inches)				
Tape Size	N Minimum	W <sub>1</sub>	W <sub>2</sub> Maximum	W <sub>3</sub>
8 mm	50 (1.969)	8.4 +1.5/-0.0 (0.331 +0.059/-0.0)	14.4 (0.567)	Shall accommodate tape width without interference
12 mm		12.4 +2.0/-0.0 (0.488 +0.078/-0.0)	18.4 (0.724)	
16 mm		16.4 +2.0/-0.0 (0.646 +0.078/-0.0)	22.4 (0.882)	



**Figure 6 – Tape Leader & Trailer Dimensions**

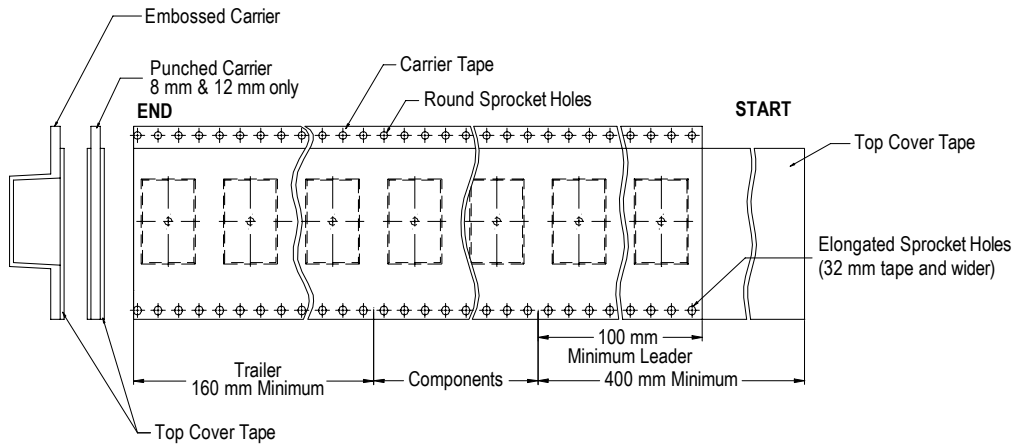

**Figure 7 – Maximum Camber**

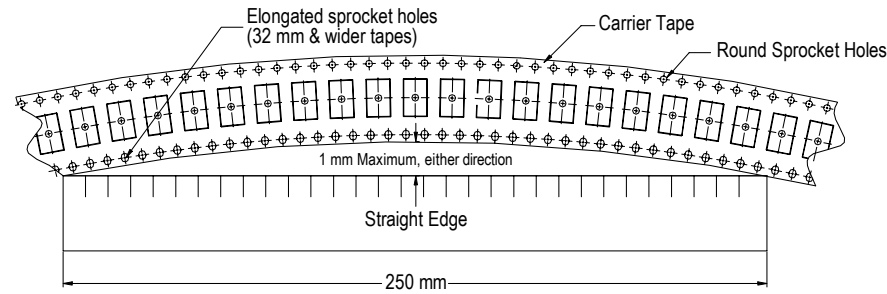

## KEMET Corporation World Headquarters

2835 KEMET Way  
Simpsonville, SC 29681

Mailing Address:  
P.O. Box 5928  
Greenville, SC 29606

www.kemet.com  
Tel: 864-963-6300  
Fax: 864-963-6521

**Corporate Offices**  
Fort Lauderdale, FL  
Tel: 954-766-2800

## North America

**Southeast**  
Lake Mary, FL  
Tel: 407-855-8886

**Northeast**  
Wilmington, MA  
Tel: 978-658-1663

**Central**  
Novi, MI  
Tel: 248-306-9353

**West**  
Milpitas, CA  
Tel: 408-433-9950

**Mexico**  
Guadalajara, Jalisco  
Tel: 52-33-3123-2141

## Europe

**Southern Europe**  
Paris, France  
Tel: 33-1-4646-1006

Sasso Marconi, Italy  
Tel: 39-051-939111

**Central Europe**  
Landsberg, Germany  
Tel: 49-8191-3350800

Kamen, Germany  
Tel: 49-2307-438110

**Northern Europe**  
Bishop's Stortford, United Kingdom  
Tel: 44-1279-460122

Espoo, Finland  
Tel: 358-9-5406-5000

## Asia

**Northeast Asia**  
Hong Kong  
Tel: 852-2305-1168

Shenzhen, China  
Tel: 86-755-2518-1306

Beijing, China  
Tel: 86-10-5829-1711

Shanghai, China  
Tel: 86-21-6447-0707

Taipei, Taiwan  
Tel: 886-2-27528585

**Southeast Asia**  
Singapore  
Tel: 65-6586-1900

Penang, Malaysia  
Tel: 60-4-6430200

Bangalore, India  
Tel: 91-806-53-76817

*Note: KEMET reserves the right to modify minor details of internal and external construction at any time in the interest of product improvement. KEMET does not assume any responsibility for infringement that might result from the use of KEMET Capacitors in potential circuit designs. KEMET is a registered trademark of KEMET Electronics Corporation.*

## Disclaimer

All product specifications, statements, information and data (collectively, the "Information") in this datasheet are subject to change. The customer is responsible for checking and verifying the extent to which the Information contained in this publication is applicable to an order at the time the order is placed.

All Information given herein is believed to be accurate and reliable, but it is presented without guarantee, warranty, or responsibility of any kind, expressed or implied.

Statements of suitability for certain applications are based on KEMET Electronics Corporation's ("KEMET") knowledge of typical operating conditions for such applications, but are not intended to constitute – and KEMET specifically disclaims – any warranty concerning suitability for a specific customer application or use. The Information is intended for use only by customers who have the requisite experience and capability to determine the correct products for their application. Any technical advice inferred from this Information or otherwise provided by KEMET with reference to the use of KEMET's products is given gratis, and KEMET assumes no obligation or liability for the advice given or results obtained.

Although KEMET designs and manufactures its products to the most stringent quality and safety standards, given the current state of the art, isolated component failures may still occur. Accordingly, customer applications which require a high degree of reliability or safety should employ suitable designs or other safeguards (such as installation of protective circuitry or redundancies) in order to ensure that the failure of an electrical component does not result in a risk of personal injury or property damage.

Although all product-related warnings, cautions and notes must be observed, the customer should not assume that all safety measures are indicated or that other measures may not be required.