



4-Mbit (128 K × 36) Flow-Through Sync SRAM

Features

- 128 K × 36 common I/O
- 3.3 V core power supply (V_{DD})
- 2.5 V or 3.3 V I/O supply (V_{DDQ})
- Fast clock-to-output times
 - 8.0 ns (100 MHz version)
- Provide high performance 2-1-1-1 access rate
- User selectable burst counter supporting Intel Pentium interleaved or linear burst sequences
- Separate processor and controller address strobes
- Synchronous self timed write
- Asynchronous output enable
- Available in Pb-free 100-pin TQFP package
- ZZ sleep mode option

Functional Description

The CY7C1345G is a 128 K × 36 synchronous cache RAM designed to interface with high speed microprocessors with minimum glue logic. The maximum access delay from clock rise is 8.0 ns (100 MHz version). A 2-bit on-chip counter captures the first address in a burst and increments the address automatically for the rest of the burst access. All synchronous inputs are gated by registers controlled by a positive edge triggered Clock Input (CLK). The synchronous inputs include all addresses, all data inputs, address pipelining chip enable (\overline{CE}_1), depth expansion chip enables (\overline{CE}_2 and \overline{CE}_3), burst control inputs (ADSC, ADSP, and ADV), write enables (\overline{BW}_x and \overline{BWE}), and global write (GW). Asynchronous inputs include the output enable (\overline{OE}) and the ZZ pin.

The CY7C1345G enables either interleaved or linear burst sequences, selected by the MODE input pin. A HIGH selects an interleaved burst sequence, while a LOW selects a linear burst sequence. Burst accesses are initiated with the processor address strobe (ADSP) or the cache controller address strobe (ADSC) inputs.

Addresses and chip enables are registered at rising edge of clock when either address strobe processor (ADSP) or address strobe controller (ADSC) is active. Subsequent burst addresses are internally generated as controlled by the Advance pin (ADV).

The CY7C1345G operates from a +3.3 V core power supply while all outputs operate with either a +2.5 or +3.3 V supply. All inputs and outputs are JEDEC standard JESD8-5 compatible.

For a complete list of related documentation, click [here](#).

Selection Guide

Description	100 MHz	Unit
Maximum access time	8.0	ns
Maximum operating current	205	mA
Maximum standby current	40	mA

Errata: For information on silicon errata, see [Errata on page 22](#). Details include trigger conditions, devices affected, and proposed workaround.

Logic Block Diagram

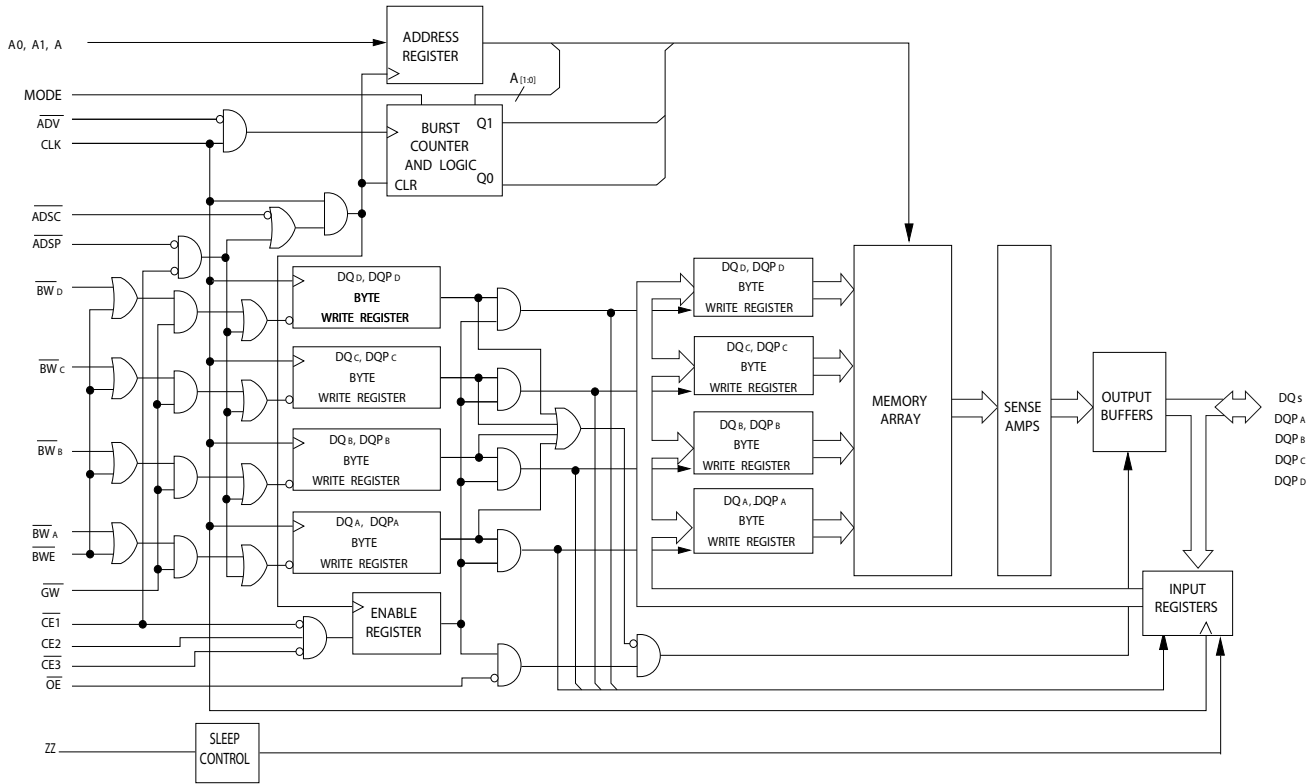

Contents

Pin Configurations	4	Switching Characteristics	14
Pin Definitions	5	Timing Diagrams	15
Functional Overview	7	Ordering Information	19
Single Read Accesses	7	Ordering Code Definitions	19
Single Write Accesses Initiated by $\overline{\text{ADSP}}$	7	Package Diagrams	20
Single Write Accesses Initiated by ADSC	7	Acronyms	21
Burst Sequences	7	Document Conventions	21
Sleep Mode	7	Units of Measure	21
Interleaved Burst Address Table	8	Errata	22
Linear Burst Address Table	8	Part Numbers Affected	22
ZZ Mode Electrical Characteristics	8	Product Status	22
Truth Table	9	Ram9 Sync ZZ Pin Issues Errata Summary	22
Truth Table for Read or Write	10	Document History Page	23
Maximum Ratings	11	Sales, Solutions, and Legal Information	25
Operating Range	11	Worldwide Sales and Design Support	25
Neutron Soft Error Immunity	11	Products	25
Electrical Characteristics	11	PSoC® Solutions	25
Capacitance	12	Cypress Developer Community	25
Thermal Resistance	12	Technical Support	25
AC Test Loads and Waveforms	13		

Pin Configurations

Figure 1. 100-pin TQFP (14 × 20 × 1.4 mm) pinout [1]

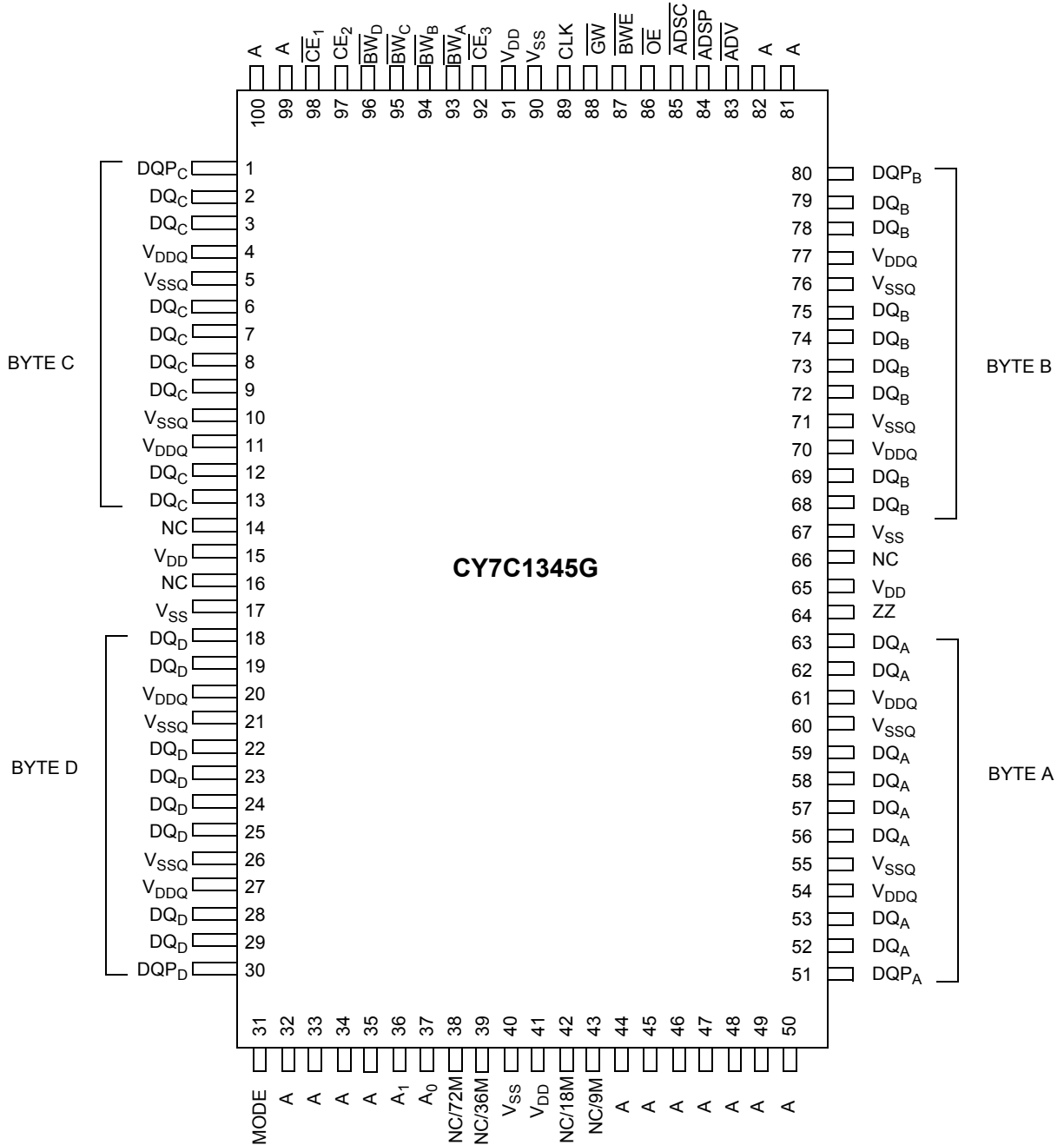

Note

1. **Errata:** The ZZ pin (Pin 64) needs to be externally connected to ground. For more information, see [Errata on page 22](#).

Pin Definitions

Name	I/O	Description
A ₀ , A ₁ , A	Input synchronous	Address inputs used to select one of the 128 K address locations. Sampled at the rising edge of the CLK if $\overline{\text{ADSP}}$ or $\overline{\text{ADSC}}$ is active LOW, and $\overline{\text{CE}}_1$, CE_2 , and $\overline{\text{CE}}_3$ are sampled active. A _[1:0] feed the two bit counter.
$\overline{\text{BW}}_A$, $\overline{\text{BW}}_B$, $\overline{\text{BW}}_C$, $\overline{\text{BW}}_D$	Input synchronous	Byte write select inputs, active LOW. Qualified with $\overline{\text{BWE}}$ to conduct byte writes to the SRAM. Sampled on the rising edge of CLK.
$\overline{\text{GW}}$	Input synchronous	Global write enable input, active LOW. When asserted LOW on the rising edge of CLK, a global write is conducted (all bytes are written, regardless of the values on $\overline{\text{BW}}_{[A:D]}$ and $\overline{\text{BWE}}$).
$\overline{\text{BWE}}$	Input synchronous	Byte write enable input, active LOW. Sampled on the rising edge of CLK. This signal is asserted LOW to conduct a byte write.
CLK	Input clock	Clock input. Used to capture all synchronous inputs to the device. Also used to increment the burst counter when $\overline{\text{ADV}}$ is asserted LOW, during a burst operation.
$\overline{\text{CE}}_1$	Input synchronous	Chip enable 1 input, active LOW. Sampled on the rising edge of CLK. Used in conjunction with CE_2 and CE_3 to select or deselect the device. $\overline{\text{ADSP}}$ is ignored if $\overline{\text{CE}}_1$ is HIGH. $\overline{\text{CE}}_1$ is sampled only when a new external address is loaded.
CE_2	Input synchronous	Chip enable 2 input, active HIGH. Sampled on the rising edge of CLK. Used in conjunction with $\overline{\text{CE}}_1$ and CE_3 to select or deselect the device. CE_2 is sampled only when a new external address is loaded.
$\overline{\text{CE}}_3$	Input synchronous	Chip enable 3 input, active LOW. Sampled on the rising edge of CLK. Used in conjunction with $\overline{\text{CE}}_1$ and CE_2 to select or deselect the device. $\overline{\text{CE}}_3$ is sampled only when a new external address is loaded.
$\overline{\text{OE}}$	Input asynchronous	Output enable, asynchronous input, active LOW. Controls the direction of the IO pins. When LOW, the IO pins act as outputs. When deasserted HIGH, IO pins are tristated and act as input data pins. $\overline{\text{OE}}$ is masked during the first clock of a read cycle when emerging from a deselected state.
$\overline{\text{ADV}}$	Input synchronous	Advance input signal, Sampled on the Rising Edge of CLK. When asserted, it automatically increments the address in a burst cycle.
$\overline{\text{ADSP}}$	Input synchronous	Address strobe from processor, sampled on the rising edge of CLK, active LOW. When asserted LOW, addresses presented to the device are captured in the address registers. A _[1:0] are also loaded into the burst counter. When $\overline{\text{ADSP}}$ and $\overline{\text{ADSC}}$ are both asserted, only $\overline{\text{ADSP}}$ is recognized. $\overline{\text{ADSP}}$ is ignored when $\overline{\text{CE}}_1$ is deasserted HIGH.
$\overline{\text{ADSC}}$	Input synchronous	Address strobe from controller, sampled on the rising edge of CLK, active LOW. When asserted LOW, addresses presented to the device are captured in the address registers. A _[1:0] are also loaded into the burst counter. When $\overline{\text{ADSP}}$ and $\overline{\text{ADSC}}$ are both asserted, only $\overline{\text{ADSP}}$ is recognized.
$\overline{\text{ZZ}}^{[2]}$	Input asynchronous	ZZ sleep input, active HIGH. When asserted HIGH places the device in a non-time critical sleep condition with data integrity preserved. During normal operation, this pin is low or left floating. ZZ pin has an internal pull-down.
DQ _s , DQP _A , DQP _B , DQP _C , DQP _D	IO synchronous	Bidirectional data IO lines. As inputs, they feed into an on-chip data register that is triggered by the rising edge of CLK. As outputs, they deliver the data contained in the memory location specified by the addresses presented during the previous clock rise of the read cycle. The direction of the pins is controlled by $\overline{\text{OE}}$. When $\overline{\text{OE}}$ is asserted LOW, the pins act as outputs. When HIGH, DQ _s and DQP _[A:D] are placed in a tristate condition.

Note

- Errata:** The ZZ pin (Pin 64) needs to be externally connected to ground. For more information, see [Errata on page 22](#).

Pin Definitions *(continued)*

Name	I/O	Description
V _{DD}	Power supply	Power supply inputs to the core of the device.
V _{SS}	Ground	Ground for the core of the device.
V _{DDQ}	IO power supply	Power supply for the IO circuitry.
V _{SSQ}	IO ground	Ground for the IO circuitry.
MODE	Input static	Selects burst order. When tied to GND selects linear burst sequence. When tied to V _{DD} or left floating selects interleaved burst sequence. This is a strap pin and must remain static during device operation. Mode pin has an internal pull up.
NC	–	No connects. Not Internally connected to the die.
NC/9M, NC/18M, NC/36M, NC/72M, NC/144M, NC/288M, NC/576M, NC/1G	–	No connects. Not internally connected to the die. NC/9M, NC/18M, NC/36M, NC/72M, NC/144M, NC/288M, NC/576M, and NC/1G are address expansion pins and are not internally connected to the die.

Functional Overview

All synchronous inputs pass through input registers controlled by the rising edge of the clock. Maximum access delay from the clock rise (t_{CO}) is 8.0 ns (100 MHz device).

The CY7C1345G supports secondary cache in systems using either a linear or interleaved burst sequence. The interleaved burst order supports Pentium and i486™ processors. The linear burst sequence is suited for processors that use a linear burst sequence. The burst order is user selectable and is determined by sampling the MODE input. Accesses are initiated with either the processor address strobe (ADSP) or the controller address strobe (ADSC). Address advancement through the burst sequence is controlled by the ADV input. A two bit on-chip wrap around burst counter captures the first address in a burst sequence and automatically increments the address for the rest of the burst access.

Byte write operations are qualified with the byte write enable (BWE) and byte write select ($BW_{[A:D]}$) inputs. A global write enable (GW) overrides all byte write inputs and writes data to all four bytes. All writes are simplified with on-chip synchronous self timed write circuitry.

Three synchronous chip selects (\overline{CE}_1 , CE_2 , and \overline{CE}_3) and an asynchronous output enable (\overline{OE}) provide for easy bank selection and output tristate control. ADSP is ignored if CE_1 is HIGH.

Single Read Accesses

A single read access is initiated when the following conditions are satisfied at clock rise:

1. \overline{CE}_1 , CE_2 , and \overline{CE}_3 are all asserted active.
2. ADSP or ADSC is asserted LOW (if the access is initiated by ADSC, the write inputs are deasserted during this first cycle).

The address presented to the address inputs is latched into the address register and the burst counter or control logic and presented to the memory core. If the \overline{OE} input is asserted LOW, the requested data is available at the data outputs a maximum to t_{CDV} after clock rise. ADSP is ignored if \overline{CE}_1 is HIGH.

Single Write Accesses Initiated by ADSP

Single write access is initiated when the following conditions are satisfied at clock rise:

1. \overline{CE}_1 , CE_2 , and \overline{CE}_3 are all asserted active
2. ADSP is asserted LOW.

The addresses presented are loaded into the address register and the burst inputs (GW, BWE, and BW_x) are ignored during this first clock cycle. If the write inputs are asserted active (see [Truth Table for Read or Write on page 10](#) for appropriate states that indicate a write) on the next clock rise, the appropriate data is

latched and written into the device. Byte writes are allowed. During byte writes, BW_A controls DQ_A and BW_B controls DQ_B , BW_C controls DQ_C , and BW_D controls DQ_D . All IOs are tristated during a byte write. Since this is a common IO device, the asynchronous \overline{OE} input signal is deasserted and the IOs are tristated prior to the presentation of data to DQ_s . As a safety precaution, the data lines are tristated after a write cycle is detected, regardless of the state of \overline{OE} .

Single Write Accesses Initiated by ADSC

This write access is initiated when the following conditions are satisfied at clock rise:

1. \overline{CE}_1 , CE_2 , and \overline{CE}_3 are all asserted active.
2. ADSC is asserted LOW.
3. ADSP is deasserted HIGH
4. The write input signals (\overline{GW} , \overline{BWE} , and \overline{BW}_x) indicate a write access. ADSC is ignored if ADSP is active LOW.

The addresses presented are loaded into the address register and the burst counter or control logic and delivered to the memory core. The information presented to $DQ_{[D:A]}$ is written into the specified address location. Byte writes are allowed. During byte writes, \overline{BW}_A controls DQ_A , \overline{BW}_B controls DQ_B , \overline{BW}_C controls DQ_C , and \overline{BW}_D controls DQ_D . All IOs and even a byte write are tristated when a write is detected. Since this is a common IO device, the asynchronous \overline{OE} input signal is deasserted and the IOs are tristated prior to the presentation of data to DQ_s . As a safety precaution, the data lines are tristated after a write cycle is detected, regardless of the state of \overline{OE} .

Burst Sequences

The CY7C1345G provides an on-chip two bit wrap around burst counter inside the SRAM. The burst counter is fed by $A_{[1:0]}$ and follows either a linear or interleaved burst order. The burst order is determined by the state of the MODE input. A LOW on MODE selects a linear burst sequence. A HIGH on MODE selects an interleaved burst order. Leaving MODE unconnected causes the device to default to a interleaved burst sequence.

Sleep Mode

The ZZ input pin is an asynchronous input. Asserting ZZ places the SRAM in a power conservation sleep mode. Two clock cycles are required to enter into or exit from this sleep mode. In this mode, data integrity is guaranteed. Accesses pending when entering the sleep mode are not considered valid nor is the completion of the operation guaranteed. The device is deselected prior to entering the sleep mode. CE_s , ADSP, and ADSC must remain inactive for the duration of t_{ZZREC} after the ZZ input returns LOW.

Interleaved Burst Address Table

 (MODE = Floating or V_{DD})

First Address A1:A0	Second Address A1:A0	Third Address A1:A0	Fourth Address A1:A0
00	01	10	11
01	00	11	10
10	11	00	01
11	10	01	00

Linear Burst Address Table

(MODE = GND)

First Address A1:A0	Second Address A1:A0	Third Address A1:A0	Fourth Address A1:A0
00	01	10	11
01	10	11	00
10	11	00	01
11	00	01	10

ZZ Mode Electrical Characteristics

Parameter	Description	Test Conditions	Min	Max	Unit
I_{DDZZ}	Sleep mode standby current	$ZZ \geq V_{DD} - 0.2 V$	–	40	mA
t_{ZZS}	Device operation to ZZ	$ZZ \geq V_{DD} - 0.2 V$	–	$2t_{CYC}$	ns
t_{ZZREC}	ZZ recovery time	$ZZ \leq 0.2 V$	$2t_{CYC}$	–	ns
t_{ZZI}	ZZ active to sleep current	This parameter is sampled	–	$2t_{CYC}$	ns
t_{RZZI}	ZZ inactive to exit sleep current	This parameter is sampled	0	–	ns

Truth Table

The Truth Table for part CY7C1345G is as follows. [3, 4, 5, 6, 7]

Cycle Description	Address Used	CE ₁	CE ₂	CE ₃	ZZ	ADSP	ADSC	ADV	WRITE	OE	CLK	DQ
Deselected cycle, power-down	None	H	X	X	L	X	L	X	X	X	L-H	Tri-state
Deselected cycle, power-down	None	L	L	X	L	L	X	X	X	X	L-H	Tri-state
Deselected cycle, power-down	None	L	X	H	L	L	X	X	X	X	L-H	Tri-state
Deselected cycle, power-down	None	L	L	X	L	H	L	X	X	X	L-H	Tri-state
Deselected cycle, power-down	None	X	X	X	L	H	L	X	X	X	L-H	Tri-state
Sleep mode, power-down	None	X	X	X	H	X	X	X	X	X	X	Tri-state
Read cycle, begin burst	External	L	H	L	L	L	X	X	X	L	L-H	Q
Read cycle, begin burst	External	L	H	L	L	L	X	X	X	H	L-H	Tri-state
Write cycle, begin burst	External	L	H	L	L	H	L	X	L	X	L-H	D
Read cycle, begin burst	External	L	H	L	L	H	L	X	H	L	L-H	Q
Read cycle, begin burst	External	L	H	L	L	H	L	X	H	H	L-H	Tri-state
Read cycle, continue burst	Next	X	X	X	L	H	H	L	H	L	L-H	Q
Read cycle, continue burst	Next	X	X	X	L	H	H	L	H	H	L-H	Tri-state
Read cycle, continue burst	Next	H	X	X	L	X	H	L	H	L	L-H	Q
Read cycle, continue burst	Next	H	X	X	L	X	H	L	H	H	L-H	Tri-state
Write cycle, continue burst	Next	X	X	X	L	H	H	L	L	X	L-H	D
Write cycle, continue burst	Next	H	X	X	L	X	H	L	L	X	L-H	D
Read cycle, suspend burst	Current	X	X	X	L	H	H	H	H	L	L-H	Q
Read cycle, suspend burst	Current	X	X	X	L	H	H	H	H	H	L-H	Tri-state
Read cycle, suspend burst	Current	H	X	X	L	X	H	H	H	L	L-H	Q
Read cycle, suspend burst	Current	H	X	X	L	X	H	H	H	H	L-H	Tri-state
Write cycle, suspend burst	Current	X	X	X	L	H	H	H	L	X	L-H	D
Write cycle, suspend burst	Current	H	X	X	L	X	H	H	L	X	L-H	D

Notes

- X = "Don't Care," H = Logic HIGH, and L = Logic LOW.
- WRITE = L when any one or more byte write enable signals ($\overline{BW_A}$, $\overline{BW_B}$, $\overline{BW_C}$, $\overline{BW_D}$) and $\overline{BWE} = L$ or $\overline{GW} = L$. WRITE = H when all byte write enable signals ($\overline{BW_A}$, $\overline{BW_B}$, $\overline{BW_C}$, $\overline{BW_D}$), BWE, GW = H.
- The DQ pins are controlled by the current cycle and the OE signal. OE is asynchronous and is not sampled with the clock.
- The SRAM always initiates a read cycle when ADSP is asserted, regardless of the state of GW, BWE, or $BW_{[A:D]}$. Writes may occur only on subsequent clocks after the ADSP or with the assertion of ADSC. As a result, OE is driven HIGH prior to the start of the write cycle to enable the outputs to tristate. OE is a "Do Not Care" for the remainder of the write cycle.
- OE is asynchronous and is not sampled with the clock rise. It is masked internally during write cycles. During a read cycle all data bits are tristate when OE is inactive or when the device is deselected, and all data bits behave as output when OE is active (LOW).

Truth Table for Read or Write

The Truth Table for read or write for part CY7C1345G is as follows. [8, 9]

Function	GW	BWE	BW _D	BW _C	BW _B	BW _A
Read	H	H	X	X	X	X
Read	H	L	H	H	H	H
Write byte (A, DQP _A)	H	L	H	H	H	L
Write byte (B, DQP _B)	H	L	H	H	L	H
Write bytes (B, A, DQP _A , DQP _B)	H	L	H	H	L	L
Write byte (C, DQP _C)	H	L	H	L	H	H
Write bytes (C, A, DQP _C , DQP _A)	H	L	H	L	H	L
Write bytes (C, B, DQP _C , DQP _B)	H	L	H	L	L	H
Write bytes (C, B, A, DQP _C , DQP _B , DQP _A)	H	L	H	L	L	L
Write byte (D, DQP _D)	H	L	L	H	H	H
Write bytes (D, A, DQP _D , DQP _A)	H	L	L	H	H	L
Write bytes (D, B, DQP _D , DQP _B)	H	L	L	H	L	H
Write bytes (D, B, A, DQP _D , DQP _B , DQP _A)	H	L	L	H	L	L
Write bytes (D, B, DQP _D , DQP _B)	H	L	L	L	H	H
Write bytes (D, B, A, DQP _D , DQP _C , DQP _A)	H	L	L	L	H	L
Write bytes (D, C, A, DQP _D , DQP _B , DQP _A)	H	L	L	L	L	H
Write all bytes	H	L	L	L	L	L
Write all bytes	L	X	X	X	X	X

Note

8. X = "Don't Care," H = Logic HIGH, and L = Logic LOW.

9. This table is only a partial listing of the byte write combinations. Any combination of \overline{BW}_x is valid. Appropriate write is done based on the active byte write.

Maximum Ratings

Exceeding the maximum ratings may shorten the battery life of the device. These user guidelines are not tested.

Storage temperature	-65 °C to +150 °C
Ambient temperature with power applied	-55 °C to +125 °C
Supply voltage on V _{DD} relative to GND	-0.5 V to +4.6 V
Supply voltage on V _{DDQ} relative to GND	-0.5 V to +V _{DD}
DC voltage applied to outputs in tristate	-0.5 V to V _{DDQ} + 0.5 V
DC input voltage	-0.5 V to V _{DD} + 0.5 V
Current into outputs (LOW)	20 mA
Static discharge voltage (MIL-STD-883, method 3015)	> 2001 V
Latch up current	> 200 mA

Operating Range

Range	Ambient Temperature	V _{DD}	V _{DDQ}
Commercial	0 °C to +70 °C	3.3 V – 5% / + 10%	2.5 V – 5% to V _{DD}
Industrial	-40 °C to +85 °C		

Neutron Soft Error Immunity

Parameter	Description	Test Conditions	Typ	Max*	Unit
LSBU	Logical single bit upsets	25 °C	361	394	FIT/Mb
LMBU	Logical multi bit upsets	25 °C	0	0.01	FIT/Mb
SEL	Single event latch up	85 °C	0	0.1	FIT/Dev

* No LMBU or SEL events occurred during testing; this column represents a statistical χ^2 , 95% confidence limit calculation. For more details refer to Application Note AN54908 "Accelerated Neutron SER Testing and Calculation of Terrestrial Failure Rates"

Electrical Characteristics

Over the Operating Range

Parameter ^[10, 11]	Description	Test Conditions	Min	Max	Unit	
V _{DD}	Power supply voltage		3.135	3.6	V	
V _{DDQ}	IO supply voltage		2.375	V _{DD}	V	
V _{OH}	Output HIGH voltage	For 3.3 V IO, I _{OH} = -4.0 mA	2.4	-	V	
		For 2.5 V IO, I _{OH} = -1.0 mA	2.0	-	V	
V _{OL}	Output LOW voltage	For 3.3 V IO, I _{OL} = 8.0 mA	-	0.4	V	
		For 2.5 V IO, I _{OL} = 1.0 mA	-	0.4	V	
V _{IH}	Input HIGH voltage	For 3.3 V IO	2.0	V _{DD} + 0.3 V	V	
		For 2.5 V IO	1.7	V _{DD} + 0.3 V	V	
V _{IL}	Input LOW voltage ^[10]	For 3.3 V IO	-0.3	0.8	V	
		For 2.5 V IO	-0.3	0.7	V	
I _X	Input leakage current except ZZ and MODE	GND ≤ V _I ≤ V _{DDQ}	-5	5	μA	
		Input current of MODE	Input = V _{SS}	-30	-	μA
		Input = V _{DD}	-	5	μA	
		Input current of ZZ	Input = V _{SS}	-5	-	μA
Input = V _{DD}	-	30	μA			
I _{OZ}	Output leakage current	GND ≤ V _I ≤ V _{DDQ} , output disabled	-5	5	μA	
I _{DD}	V _{DD} operating supply current	V _{DD} = Max, I _{OUT} = 0 mA, f = f _{MAX} = 1/t _{CYC}	10 ns cycle, 100 MHz	-	205	mA

Notes

10. Overshoot: V_{IH(AC)} < V_{DD} + 1.5 V (Pulse width less than t_{CYC}/2), undershoot: V_{IL(AC)} > -2 V (Pulse width less than t_{CYC}/2).
 11. T_{Power up}: Assumes a linear ramp from 0 V to V_{DD(min)} within 200 ms. During this time V_{IH} < V_{DD} and V_{DDQ} ≤ V_{DD}.

Electrical Characteristics *(continued)*

Over the Operating Range

Parameter ^[10, 11]	Description	Test Conditions	Min	Max	Unit
I _{SB1}	Automatic CE power-down current – TTL inputs	Max V _{DD} , device deselected, V _{IN} ≥ V _{IH} or V _{IN} ≤ V _{IL} , f = f _{MAX} , inputs switching	–	80	mA
I _{SB2}	Automatic CE power-down current – CMOS inputs	Max V _{DD} , device deselected, V _{IN} ≥ V _{DD} – 0.3 V or V _{IN} ≤ 0.3 V, f = 0, inputs static	–	40	mA
I _{SB3}	Automatic CE power-down current – CMOS inputs	Max V _{DD} , device deselected, V _{IN} ≥ V _{DDQ} – 0.3 V or V _{IN} ≤ 0.3 V, f = f _{MAX} , inputs switching	–	65	mA
I _{SB4}	Automatic CE power-down current – TTL inputs	Max V _{DD} , device deselected, V _{IN} ≥ V _{DD} – 0.3 V or V _{IN} ≤ 0.3 V, f = 0, inputs static	–	45	mA

Capacitance

Parameter ^[12]	Description	Test Conditions	100-pin TQFP Max	Unit
C _{IN}	Input capacitance	T _A = 25 °C, f = 1 MHz, V _{DD} = 3.3 V, V _{DDQ} = 3.3 V	5	pF
C _{CLK}	Clock input capacitance		5	pF
C _{IO}	Input or output capacitance		5	pF

Thermal Resistance

Parameter ^[12]	Description	Test Conditions	100-pin TQFP Package	Unit
Θ _{JA}	Thermal resistance (junction to ambient)	Test conditions follow standard test methods and procedures for measuring thermal impedance, per EIA/JESD51.	30.32	°C/W
Θ _{JC}	Thermal resistance (junction to case)		6.85	°C/W

Note

12. Tested initially and after any design or process change that may affect these parameters.

AC Test Loads and Waveforms

Figure 2. AC Test Loads and Waveforms

3.3 V I/O Test Load

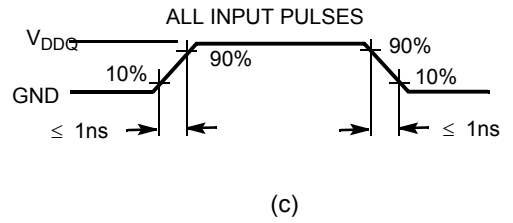
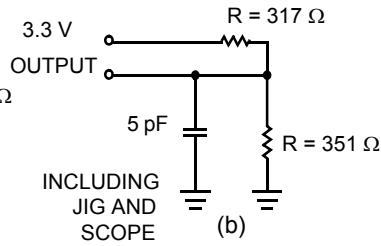
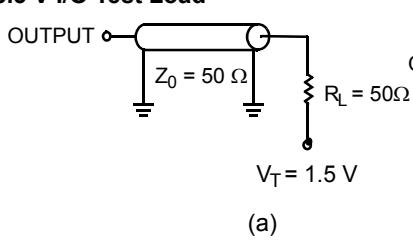

2.5 V I/O Test Load

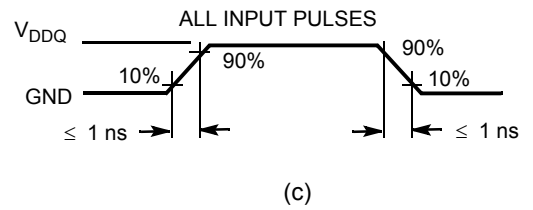
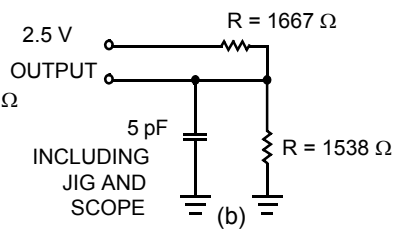
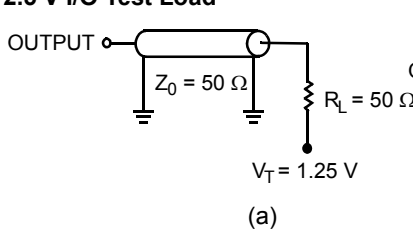

Switching Characteristics

Over the Operating Range

Parameter [13, 14]	Description	-100		Unit
		Min	Max	
t_{POWER}	$V_{DD}(\text{typical})$ to the first access [15]	1	–	ms
Clock				
t_{CYC}	Clock cycle time	10	–	ns
t_{CH}	Clock HIGH	4.0	–	ns
t_{CL}	Clock LOW	4.0	–	ns
Output Times				
t_{CDV}	Data output valid after CLK rise	–	8.0	ns
t_{DOH}	Data output hold after CLK rise	2.0	–	ns
t_{CLZ}	Clock to low Z [16, 17, 18]	0	–	ns
t_{CHZ}	Clock to high Z [16, 17, 18]	–	3.5	ns
$t_{OE\bar{V}}$	\overline{OE} LOW to output valid	–	3.5	ns
$t_{OE\bar{L}Z}$	\overline{OE} LOW to output low Z [16, 17, 18]	0	–	ns
$t_{OE\bar{H}Z}$	\overline{OE} HIGH to output high Z [16, 17, 18]	–	3.5	ns
Setup Times				
t_{AS}	Address setup before CLK rise	2.0	–	ns
t_{ADS}	ADSP, ADSC setup before CLK rise	2.0	–	ns
$t_{AD\bar{V}S}$	\overline{ADV} setup before CLK rise	2.0	–	ns
t_{WES}	\overline{GW} , \overline{BWE} , \overline{BW}_x setup before CLK rise	2.0	–	ns
t_{DS}	Data input setup before CLK rise	2.0	–	ns
t_{CES}	Chip enable setup	2.0	–	ns
Hold Times				
t_{AH}	Address hold after CLK rise	0.5	–	ns
t_{ADH}	ADSP, ADSC hold after CLK rise	0.5	–	ns
t_{WEH}	\overline{GW} , \overline{BWE} , \overline{BW}_x hold after CLK rise	0.5	–	ns
$t_{AD\bar{V}H}$	\overline{ADV} hold after CLK rise	0.5	–	ns
t_{DH}	Data input hold after CLK rise	0.5	–	ns
t_{CEH}	Chip enable hold after CLK rise	0.5	–	ns

Notes

13. Timing reference level is 1.5 V when $V_{DDQ} = 3.3$ V and is 1.25 V when $V_{DDQ} = 2.5$ V.

14. Test conditions shown in (a) of Figure 2 on page 13 unless otherwise noted.

15. This part has a voltage regulator internally; t_{POWER} is the time that the power needs to be supplied above $V_{DD(\text{minimum})}$ initially before a read or write operation is initiated.

16. t_{CHLZ} , t_{CLZ} , $t_{OE\bar{L}Z}$, and $t_{OE\bar{H}Z}$ are specified with AC test conditions shown in (b) of Figure 2 on page 13. Transition is measured ± 200 mV from steady state voltage.

17. At any voltage and temperature, $t_{OE\bar{H}Z}$ is less than $t_{OE\bar{L}Z}$ and t_{CHZ} is less than t_{CLZ} to eliminate bus contention between SRAMs when sharing the same data bus.

These specifications do not imply a bus contention condition, but reflect parameters guaranteed over worst case user conditions. Device is designed to achieve high Z

prior to low Z under the same system conditions.

18. This parameter is sampled and not 100% tested.

Timing Diagrams

Figure 3. Read Cycle Timing [19]

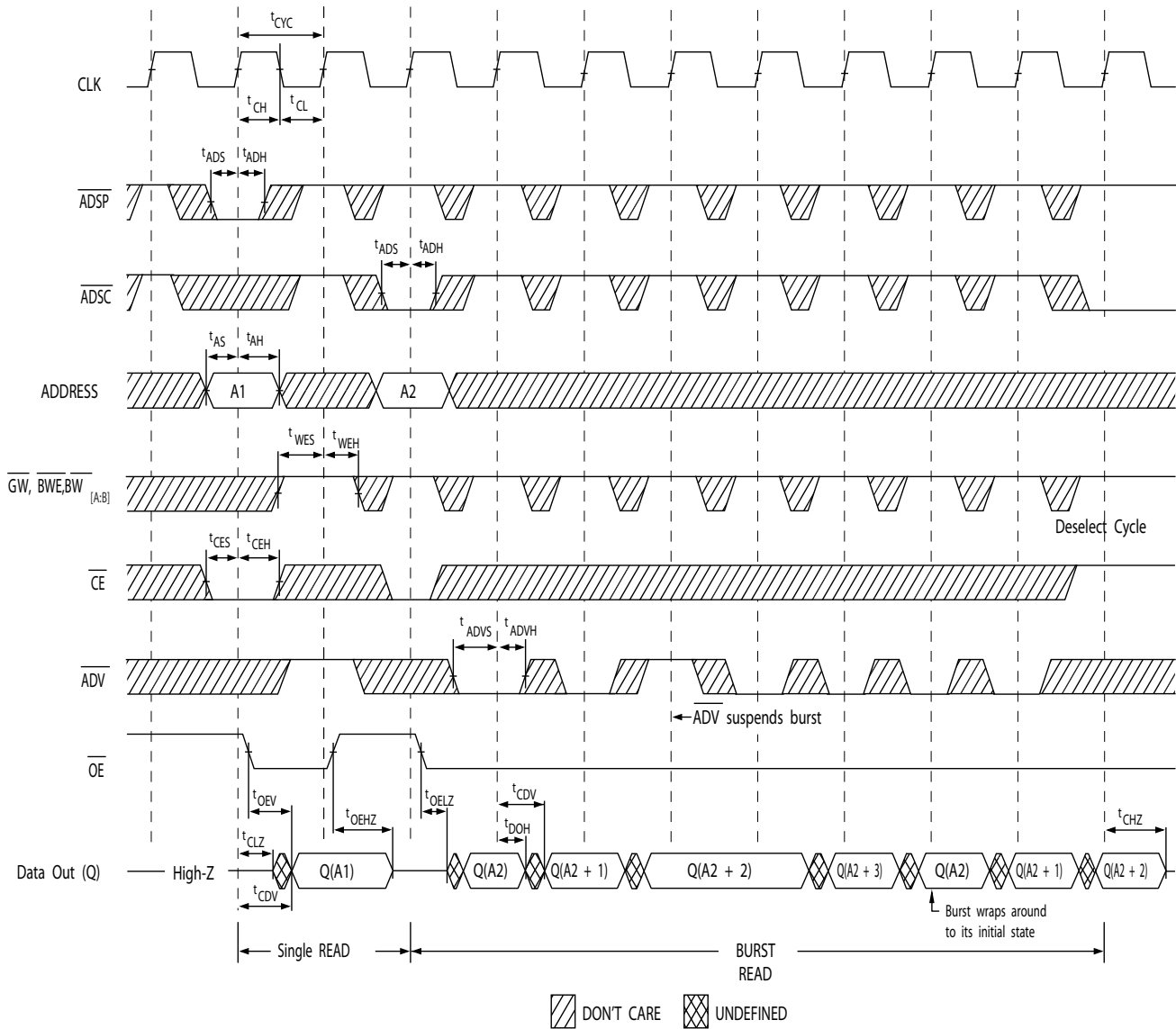

Note

19. On this diagram, when \overline{CE} is LOW: \overline{CE}_1 is LOW, \overline{CE}_2 is HIGH and \overline{CE}_3 is LOW. When \overline{CE} is HIGH: \overline{CE}_1 is HIGH or \overline{CE}_2 is LOW or \overline{CE}_3 is HIGH.

Timing Diagrams (continued)

Figure 4. Write Cycle Timing [20, 21]

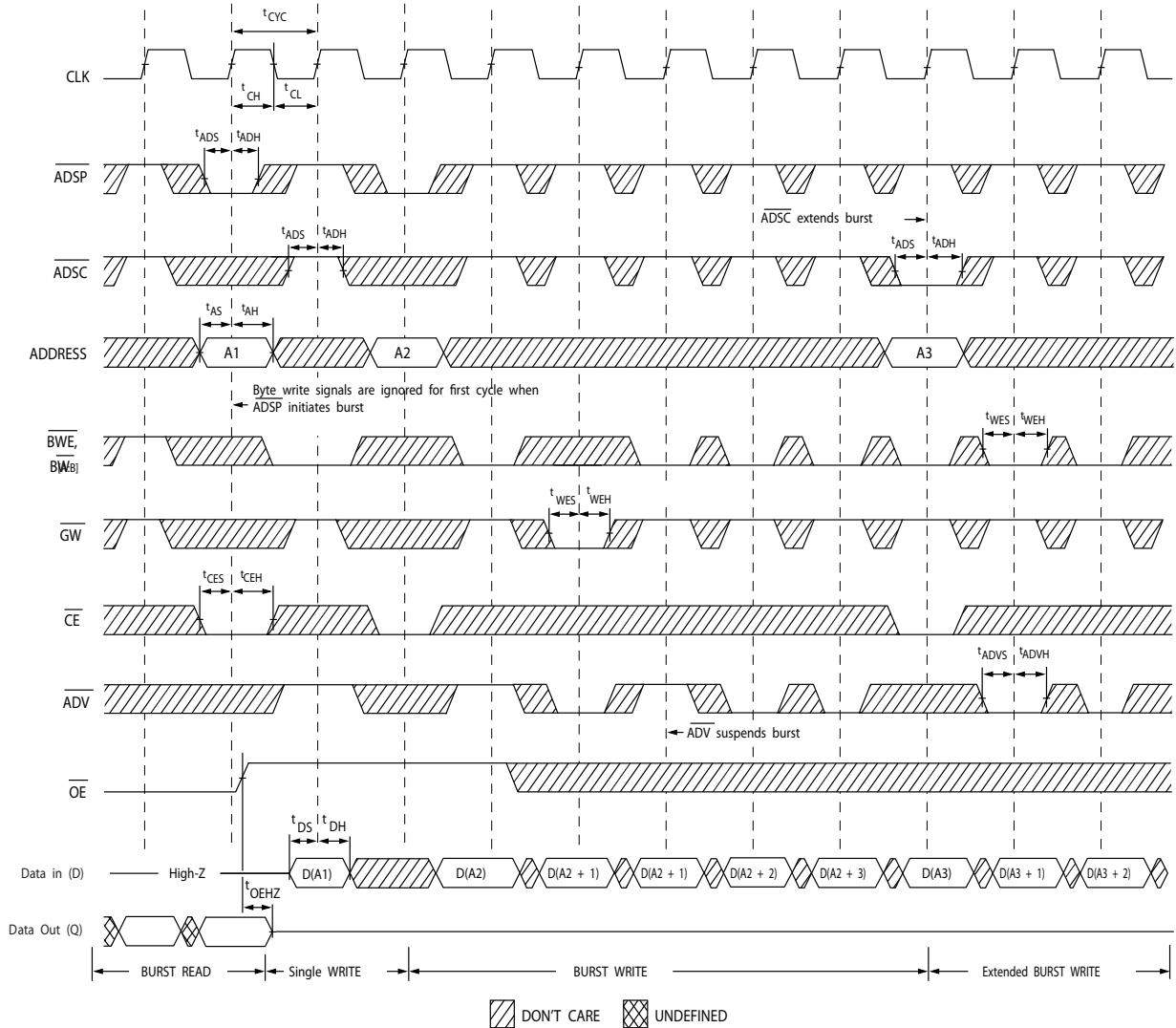

Notes

20. On this diagram, when \overline{CE} is LOW: \overline{CE}_1 is LOW, \overline{CE}_2 is HIGH and \overline{CE}_3 is LOW. When \overline{CE} is HIGH: \overline{CE}_1 is HIGH or \overline{CE}_2 is LOW or \overline{CE}_3 is HIGH.

21. Full width write can be initiated by either \overline{GW} LOW; or by \overline{GW} HIGH, \overline{BWE} LOW and \overline{BW}_x LOW.

Timing Diagrams (continued)

Figure 5. Read/Write Timing [22, 23, 24]

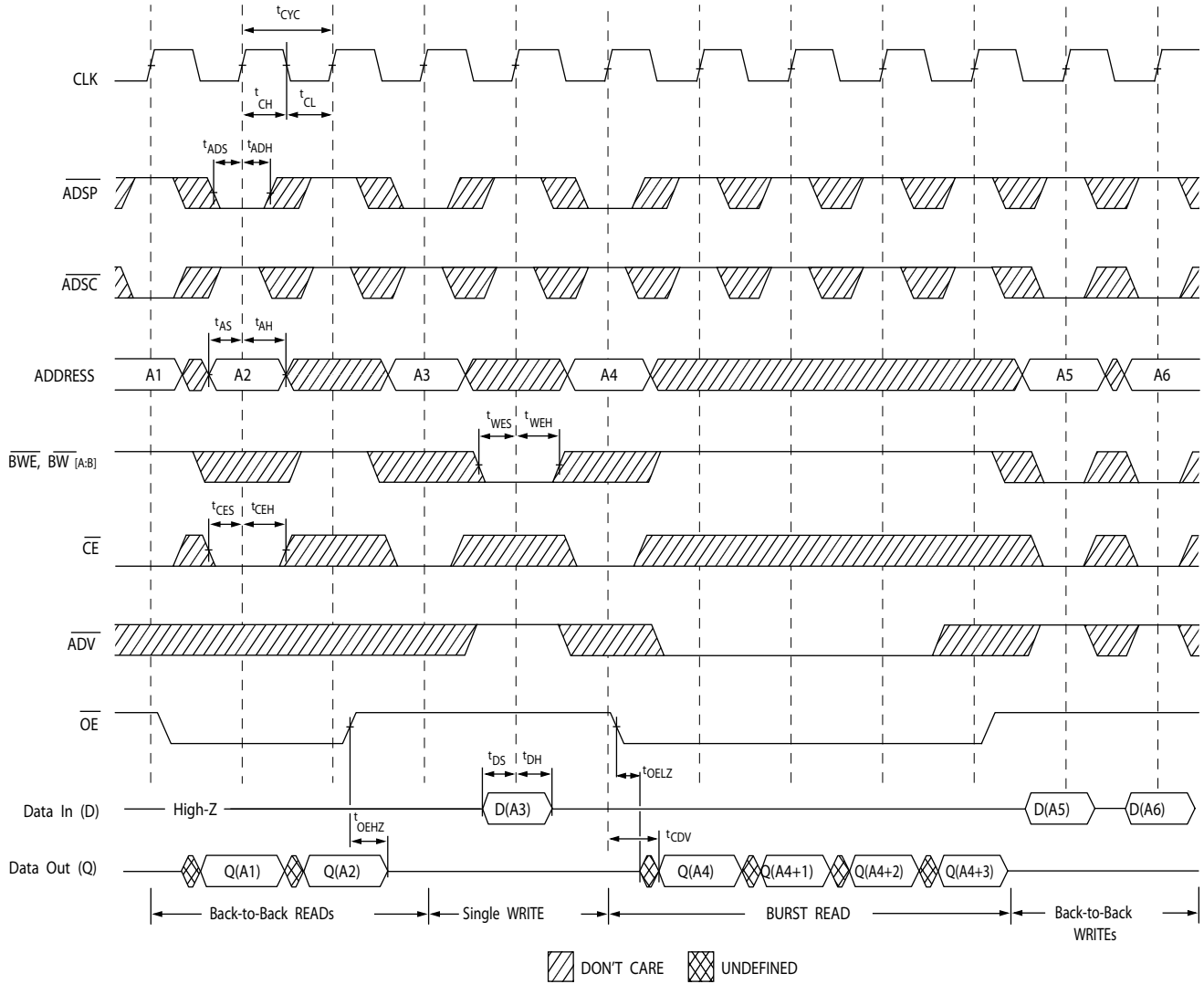

Notes

- 22. Full width write can be initiated by either \overline{GW} LOW; or by \overline{GW} HIGH, \overline{BWE} LOW and \overline{BW}_x LOW.
- 23. The data bus (Q) remains in high Z following a WRITE cycle, unless a new read access is initiated by \overline{ADSP} or \overline{ADSC} .
- 24. \overline{GW} is HIGH.

Timing Diagrams (continued)

Figure 6. ZZ Mode Timing [25, 26]

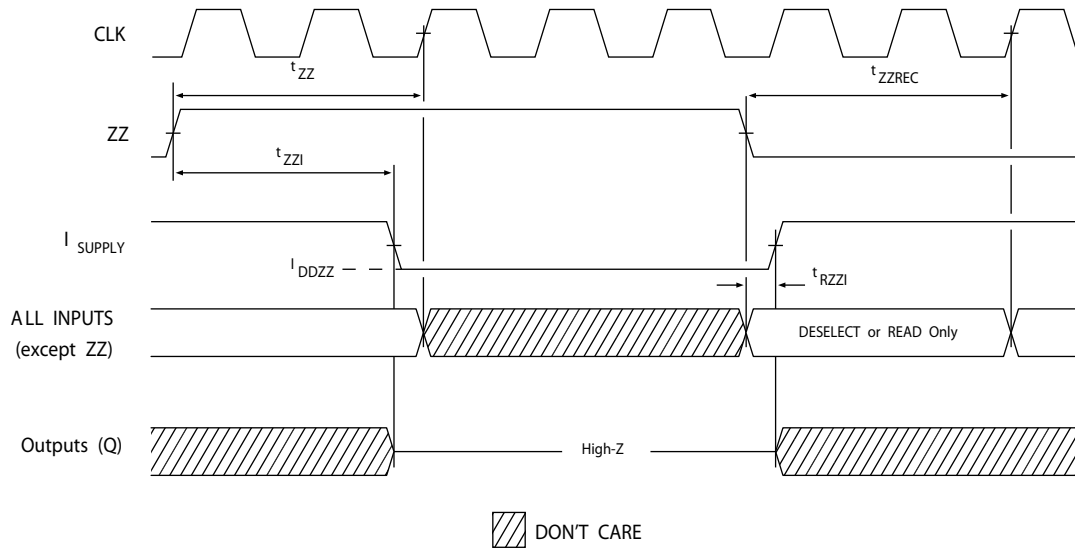

Notes

- 25. Device must be deselected when entering ZZ mode. See Truth Table on page 9 for all possible signal conditions to deselect the device.
- 26. DQs are in high Z when exiting ZZ sleep mode.

Ordering Information

The table below contains only the parts that are currently available. If you don't see what you are looking for, please contact your local sales representative. For more information, visit the Cypress website at www.cypress.com and refer to the product summary page at <http://www.cypress.com/products>

Cypress maintains a worldwide network of offices, solution centers, manufacturer's representatives and distributors. To find the office closest to you, visit us at <http://www.cypress.com/go/datasheet/offices>

Speed (MHz)	Ordering Code	Package Diagram	Part and Package Type	Operating Range
100	CY7C1345G-100AXC	51-85050	100-pin TQFP (14 × 20 × 1.4 mm) Pb-free	Commercial
	CY7C1345G-100AXI	51-85050	100-pin TQFP (14 × 20 × 1.4 mm) Pb-free	Industrial

Ordering Code Definitions

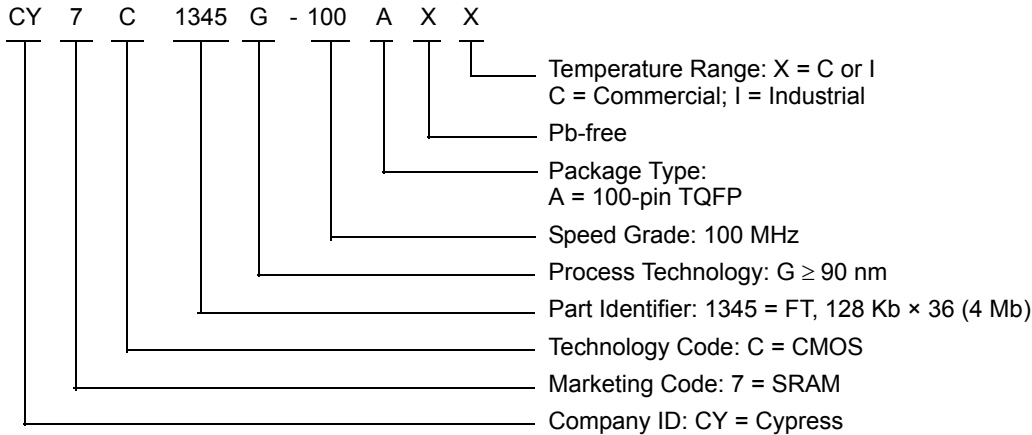

Package Diagrams

Figure 7. 100-pin TQFP (14 × 20 × 1.4 mm) A100RA Package Outline, 51-85050

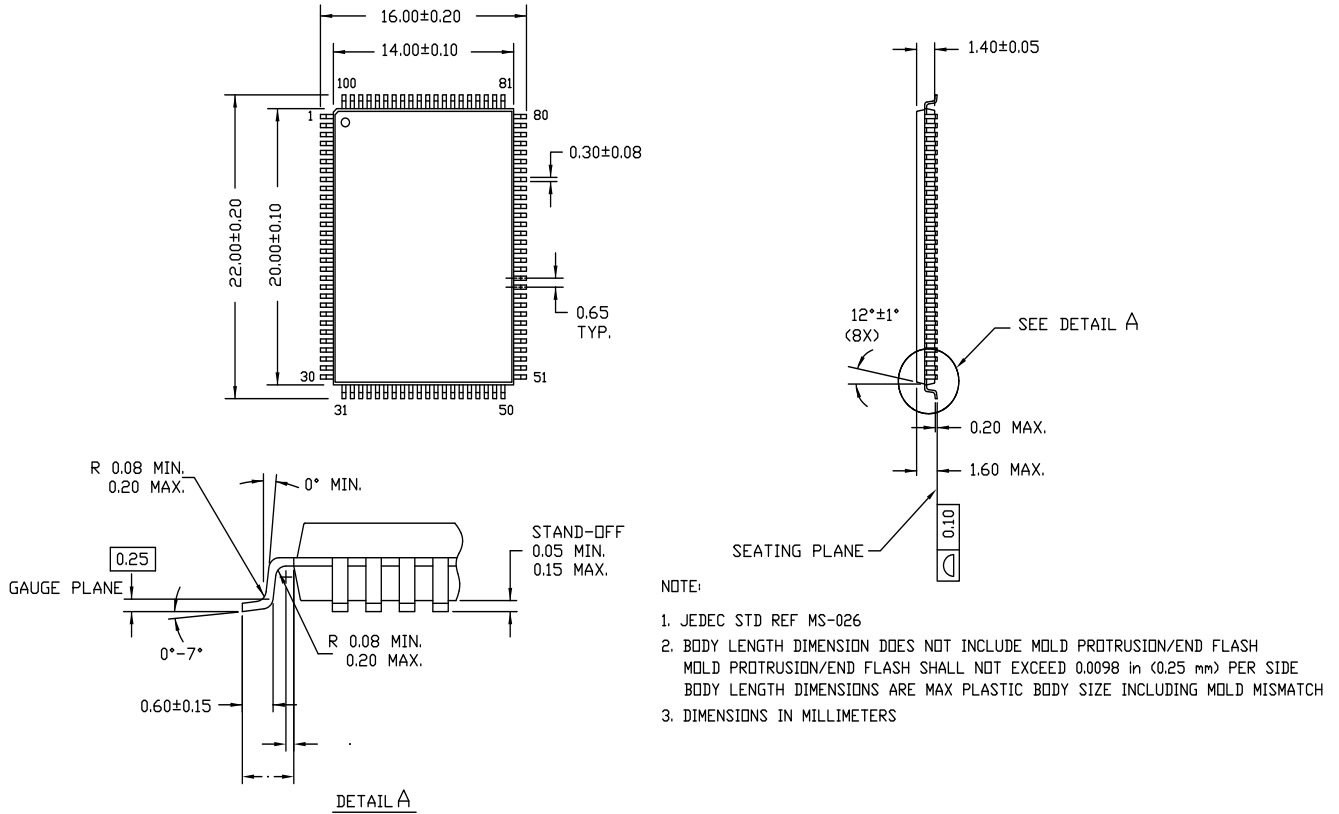

51-85050 *E

Acronyms

Acronym	Description
CMOS	Complementary Metal Oxide Semiconductor
\overline{CE}	Chip Enable
CEN	Clock Enable
GW	Global Write
I/O	Input/Output
\overline{OE}	Output Enable
SRAM	Static Random Access Memory
TQFP	Thin Quad Flat Pack
WE	Write Enable

Document Conventions

Units of Measure

Symbol	Unit of Measure
°C	degree Celsius
MHz	megahertz
μA	microampere
mA	milliampere
mm	millimeter
ms	millisecond
MHz	megahertz
ns	nanosecond
pF	picofarad
V	volt
W	watt

Errata

This section describes the Ram9 Sync ZZ pin issue. Details include trigger conditions, the devices affected, proposed workaround and silicon revision applicability. Please contact your local Cypress sales representative if you have further questions.

Part Numbers Affected

Density & Revision	Package Type	Operating Range
4Mb-Ram9 Synchronous SRAMs: CY7C134*G	100-pin TQFP	Commercial/ Industrial

Product Status

All of the devices in the Ram9 4Mb Sync family are qualified and available in production quantities.

Ram9 Sync ZZ Pin Issues Errata Summary

The following table defines the errata applicable to available Ram9 4Mb Sync family devices.

Item	Issues	Description	Device	Fix Status
1.	ZZ Pin	When asserted HIGH, the ZZ pin places device in a "sleep" condition with data integrity preserved. The ZZ pin currently does not have an internal pull-down resistor and hence cannot be left floating externally by the user during normal mode of operation.	4M-Ram9 (90nm)	For the 4M Ram9 (90 nm) devices, there is no plan to fix this issue.

1. ZZ Pin Issue

■ PROBLEM DEFINITION

The problem occurs only when the device is operated in the normal mode with ZZ pin left floating. The ZZ pin on the SRAM device does not have an internal pull-down resistor. Switching noise in the system may cause the SRAM to recognize a HIGH on the ZZ input, which may cause the SRAM to enter sleep mode. This could result in incorrect or undesirable operation of the SRAM.

■ TRIGGER CONDITIONS

Device operated with ZZ pin left floating.

■ SCOPE OF IMPACT

When the ZZ pin is left floating, the device delivers incorrect data.

■ WORKAROUND

Tie the ZZ pin externally to ground.

■ FIX STATUS

For the 4M Ram9 (90 nm) devices, there is no plan to fix this issue.

Document History Page

Document Title: CY7C1345G, 4-Mbit (128 K × 36) Flow-Through Sync SRAM				
Document Number: 38-05517				
Rev.	ECN	Orig. of Change	Submission Date	Description of Change
**	224365	RKF	See ECN	New data sheet.
*A	278513	VBL	See ECN	Updated Features (Removed 66 MHz frequency related information). Updated Selection Guide (Removed 66 MHz frequency related information). Updated Electrical Characteristics (Removed 66 MHz frequency related information). Updated Switching Characteristics (Removed 66 MHz frequency related information). Updated Ordering Information (Updated part numbers (Added Pb-free BGA package), changed TQFP package to Pb-free TQFP package, added comment on the BG Pb-free package availability below the table).
*B	333626	SYT	See ECN	Updated Features (Removed 117 MHz frequency related information). Updated Selection Guide (Removed 117 MHz frequency related information). Updated Pin Configurations (Updated Address Expansion balls in the pinouts for 100-pin TQFP and 119-ball BGA Packages as per JEDEC standards). Updated Pin Definitions . Updated Functional Overview (Updated ZZ Mode Electrical Characteristics (Replaced 'Snooze' with 'Sleep')). Updated Truth Table (Replaced 'Snooze' with 'Sleep'). Updated Electrical Characteristics (Updated test conditions for V_{OL} and V_{OH} parameters, removed 117 MHz frequency related information). Updated Switching Characteristics (Removed 117 MHz frequency related information). Updated Thermal Resistance (Replaced TBDs for Θ_{JA} and Θ_{JC} to their respective values). Updated Ordering Information (By shading and unshading MPNs as per availability, removed comment on the availability of BG Pb-free package).
*C	418633	R XU	See ECN	Changed status from Preliminary to Final. Changed address of Cypress Semiconductor Corporation from "3901 North First Street" to "198 Champion Court". Updated Electrical Characteristics (Changed "Input Load Current except ZZ and MODE" to "Input Leakage Current except ZZ and MODE", updated Note 11 (Changed test condition from $V_{IH} \leq V_{DD}$ to $V_{IH} < V_{DD}$)). Updated Ordering Information (Updated part numbers, replaced Package Name column with Package Diagram in the Ordering Information table). Replaced Package Diagrams .
*D	480124	VKN	See ECN	Updated Maximum Ratings (Added the Maximum Rating for Supply Voltage on V_{DDQ} Relative to GND). Updated Ordering Information (Updated part numbers).
*E	1274724	VKN	See ECN	Updated Timing Diagrams (Updated Figure 4).
*F	2756998	VKN	08/28/09	Included Neutron Soft Error Immunity . Modified Ordering Information (By including parts that are available, and modified the disclaimer for the Ordering information).
*G	3034798	NJY	09/21/2010	Added Ordering Code Definitions . Updated Package Diagrams . Added Acronyms and Units of Measure . Minor edits and updated in new template.
*H	3353361	PRIT	08/24/2011	Updated Package Diagrams .

Document History Page *(continued)*

Document Title: CY7C1345G, 4-Mbit (128 K × 36) Flow-Through Sync SRAM Document Number: 38-05517				
Rev.	ECN	Orig. of Change	Submission Date	Description of Change
*I	3587066	NJY / PRIT	05/10/2012	Updated Features (Removed 133 MHz frequency related information, removed 119-ball BGA package related information). Updated Functional Description (Removed “For best practice recommendations, refer to the Cypress application note SRAM System Design Guidelines ”). Updated Selection Guide (Removed 133 MHz frequency related information). Updated Pin Configurations (Removed 119-ball BGA package related information). Updated Functional Overview (Removed 133 MHz frequency related information). Updated Electrical Characteristics (Removed 133 MHz frequency related information). Updated Capacitance (Removed 119-ball BGA package related information). Updated Thermal Resistance (Removed 119-ball BGA package related information). Updated Switching Characteristics (Removed 133 MHz frequency related information). Updated Package Diagrams (Removed 119-ball BGA package related information).
*J	3753130	PRIT	09/24/2012	No technical updates. Completing sunset review.
*K	3980577	PRIT	04/24/2013	Added Errata .
*L	4039228	PRIT	06/25/2013	Added Errata Footnotes. Updated in new template.
*M	4149237	PRIT	10/07/2013	Updated Errata .
*N	4574263	PRIT	11/19/2014	Added related documentation hyperlink in page 1. Updated package diagram

Sales, Solutions, and Legal Information

Worldwide Sales and Design Support

Cypress maintains a worldwide network of offices, solution centers, manufacturer's representatives, and distributors. To find the office closest to you, visit us at [Cypress Locations](#).

Products

Automotive	cypress.com/go/automotive
Clocks & Buffers	cypress.com/go/clocks
Interface	cypress.com/go/interface
Lighting & Power Control	cypress.com/go/powerpsoc cypress.com/go/plc
Memory	cypress.com/go/memory
PSoC	cypress.com/go/psoc
Touch Sensing	cypress.com/go/touch
USB Controllers	cypress.com/go/USB
Wireless/RF	cypress.com/go/wireless

PSoC[®] Solutions

[psoc.cypress.com/solutions](#)
[PSoC 1](#) | [PSoC 3](#) | [PSoC 4](#) | [PSoC 5LP](#)

Cypress Developer Community

[Community](#) | [Forums](#) | [Blogs](#) | [Video](#) | [Training](#)

Technical Support

[cypress.com/go/support](#)

© Cypress Semiconductor Corporation, 2004-2014. The information contained herein is subject to change without notice. Cypress Semiconductor Corporation assumes no responsibility for the use of any circuitry other than circuitry embodied in a Cypress product. Nor does it convey or imply any license under patent or other rights. Cypress products are not warranted nor intended to be used for medical, life support, life saving, critical control or safety applications, unless pursuant to an express written agreement with Cypress. Furthermore, Cypress does not authorize its products for use as critical components in life-support systems where a malfunction or failure may reasonably be expected to result in significant injury to the user. The inclusion of Cypress products in life-support systems application implies that the manufacturer assumes all risk of such use and in doing so indemnifies Cypress against all charges.

Any Source Code (software and/or firmware) is owned by Cypress Semiconductor Corporation (Cypress) and is protected by and subject to worldwide patent protection (United States and foreign), United States copyright laws and international treaty provisions. Cypress hereby grants to licensee a personal, non-exclusive, non-transferable license to copy, use, modify, create derivative works of, and compile the Cypress Source Code and derivative works for the sole purpose of creating custom software and or firmware in support of licensee product to be used only in conjunction with a Cypress integrated circuit as specified in the applicable agreement. Any reproduction, modification, translation, compilation, or representation of this Source Code except as specified above is prohibited without the express written permission of Cypress.

Disclaimer: CYPRESS MAKES NO WARRANTY OF ANY KIND, EXPRESS OR IMPLIED, WITH REGARD TO THIS MATERIAL, INCLUDING, BUT NOT LIMITED TO, THE IMPLIED WARRANTIES OF MERCHANTABILITY AND FITNESS FOR A PARTICULAR PURPOSE. Cypress reserves the right to make changes without further notice to the materials described herein. Cypress does not assume any liability arising out of the application or use of any product or circuit described herein. Cypress does not authorize its products for use as critical components in life-support systems where a malfunction or failure may reasonably be expected to result in significant injury to the user. The inclusion of Cypress' product in a life-support systems application implies that the manufacturer assumes all risk of such use and in doing so indemnifies Cypress against all charges.

Use may be limited by and subject to the applicable Cypress software license agreement.