

Acoustic Components & Wireless Transmission Modules

音響部品
無線部品



音響部品

Acoustic Components

目 次 1

レシーバユニット

 ガイド 2

 製品一覧 3

 レシーバユニット 4

エレクトレット コンデンサ マイクロホン ユニット

 ガイド 5

 製品一覧 6

 全指向性 7 - 9

 単一指向性 10

 ラバーホルダ 11

MEMSマイクロホンユニット

 製品一覧 12

 マイクロホンユニット 13 - 15

 デジタルマイク 16

Contents 1

Receiver Units

 Guide 2

 Product Lineup 3

 Receiver Unit 4

Electret Condenser Microphone Units

 Guide 5

 Product Lineup 6

 Omnidirectional 7 - 9

 Unidirectional 10

 Rubber Holder 11

MEMS Microphone Units

 Product Lineup 12

 Microphone Units 13 - 15

 Digital MIC 16

音響製品

Acoustic Products

製品一覧 17

ヘッドホン 18 - 19

マイクロホン 20 - 22

スピーカ 23

Product Lineup 17

Headphones 18 - 19

Microphones 20 - 22

Speakers 23

無線モジュール

Wireless Transmission Modules

製品一覧 24

無線モジュール 25 - 26

Product Lineup 24

Wireless Transmission Modules 25 - 26

インピーダンス

レシーバの持つ、交流的抵抗分（電気的インピーダンス）のことで、周波数1000 Hzの時の値をオーム（Ω）で表現いたします。当社ではレシーバ用としては、標準的に150Ωとしておりますが、御要望により300Ω等も作製いたしております。

入力の定義

レシーバの入力は各社で基準のとり方等統一されておきませんが、基本的には、インピーダンス（at 1kHz）と等しい値の純抵抗に置き換えて、その抵抗により消費される電力としております。従ってインピーダンス（Z）入力電圧をEとした時、電力（入力）は下式より算出します。

$$P = \frac{E^2}{Z} \times 10^{-3}$$

出力音圧レベル

電話機用ハンドセットの測定法として、当社ではIEC318に規定されている人工耳に、イヤピースを取付け、レシーバ端子間に60 mVの電圧を加え、1000 Hzにおける出力音圧レベルを規定しております。

なお、各社の測定方法はおおむねこれと同様の方法で測定されておりますが、基準の取り方や入力条件等が異なる場合が多く、他社とのデータ比較はできませんので、御注意ください。

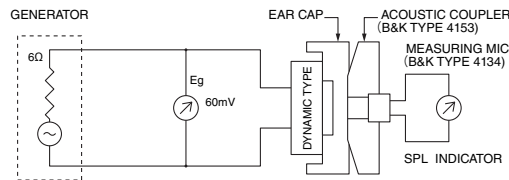

ヒアリングエイド規格適合レシーバについて

USA (米国) FCC 規格で1991年8月16日以後、各電話機は補聴器と両立性を義務づけられたことに基づき、レシーバより入力音声電流に比例した交流磁界を発生させ、それを耳掛け補聴器等内蔵されたピックアップコイルに反応させ周囲のノイズ等に影響せず、難聴者の為の通話補助を行う機能を備えたレシーバのことで、発生する交流磁界について、EIARS-504で規定されている測定法に基づき測定し、規格を満足しているものを適合レシーバと規定しております。

リーケージ測定評価

従来、電話機用レシーバの測定といえばIEC 318の人工耳を用いて密閉状態で測定する事が決められていました。また、電話機も一般的なハンドセットがほとんどであり、密閉状態での測定でも特に支障はありませんでした。ところが最近、電話機もコードレス電話・携帯電話・自動車電話、と多種多様なハンドセットが登場し、従来の測定方では必ずしも実態にそぐわない場合がでてきました。そのため、従来の密閉状態での測定とは別に実使用状態での聴感を重視するという立場から、開放状態での測定でレシーバを評価する動きが増えてきています。ホシデンとしては、開放状態での測定はITU-T p.51 LowLeakに準拠した方法により、規格化することとしました。

取扱上の注意

電話機への取付けに際し、次のことを御注意ください。

- レシーバの前面の音孔を密閉するような取付けはおさげください。
- 上から押さえる場合、レシーバに大きな荷重を加えますと特等に影響が出る場合がありますので御注意ください。
- プリント基板にはボイスコイルが半田付けされ保護接着されています。ご使用に際しては、接続用リード線は指定のランドへ半田付けされるようお願いいたします。

Impedance

The magnitude of the complex impedance at 1 kHz is expressed in ohms. As of an impedance for a receiver, we normally offer a 150-ohm impedance, but will manufacture 300-ohm and other impedances on demand.

Input power

When calculating input power it is assumed the impedance is resistive, therefore,

$$P = \frac{E^2}{Z} \times 10^3 \text{ in mW or } 10^6 \text{ in } \mu\text{W}$$

where Z is the impedance at 1 kHz in ohms
E is the input voltage in volts

Output Sound Pressure Level

As a method of measuring a telephone handset, we define the output pressure level at 1000 Hz when an earpiece is attached to the artificial ear specified in IEC318, and a voltage of 60 mV is applied across the receiver terminals.

Please note that data comparison with those of other companies is not valid because there are many differences in setting references and input conditions, although the measuring methods of other companies are almost similar to our method.

Hearing Aid Compatibility

From August 16th 1991 US FCC regulations required that all telephones in public places shall be hearing aid compatible. HAC receivers incorporate an additional coil, which produces a magnetic field that couples to the hearing aid pick-up coil.

The AC magnetic field generated conforms to EIAR S-0504.

Leakage Measuring Evaluation

Traditionally, the performance of telephone receivers was measured in a closed loop using the artificial ear specified in IEC 318. This approach did not pose any serious problems in the past because there were only a few types of telephone handsets available on the market. In recent years, however, a variety of new types of telephones such as cordless, portable and cellular telephones, have entered the market one after another, and they come equipped with various types of handsets. In the face of these new circumstances, more and more manufactures are trying to adopt the so-called "open" measurement method, in addition to the conventional closed loop method. This is because they believe that more emphasis should be put on auditory feeling in the working environment. Hosiden has also decided to adopt the open measurement method using ITU-T p.51 LowLeak

Installation in Handset

Please take care of the following points when installing in the handset:

- Avoid covering the sound ports in the front of the receiver.
- Avoid excessive mechanical load on the receiver when pressing down from the top, otherwise the performance would be affected.
- A voice coil is soldered to the printed circuit board with protective bonding. In use, connection leads should be soldered to the specified areas.

■角形 / Rectangular type

Model No.	寸法 Dimensions (mm)	質量 Mass (g)	定格入力 Nominal Input (mW)	インピーダンス Impedance (Ω)	出力音圧 S. P. L (dB/mV)	材質 Material	
						フレーム Frame	マグネット Magnet
HDR2259 (waterproof)	6 × 12 × 2	0.4	10	32	102.5 / 100	Plastic	Rare Earth

スピーカユニットについてはお客様のご要望に合わせ、設計から製造までお引き受けいたします。
We design and manufacture products based on customers request about Speaker Units.

HDR2259



Waterproof

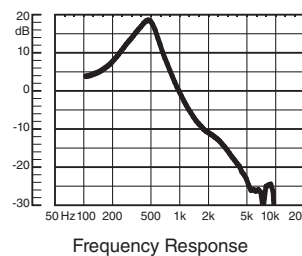
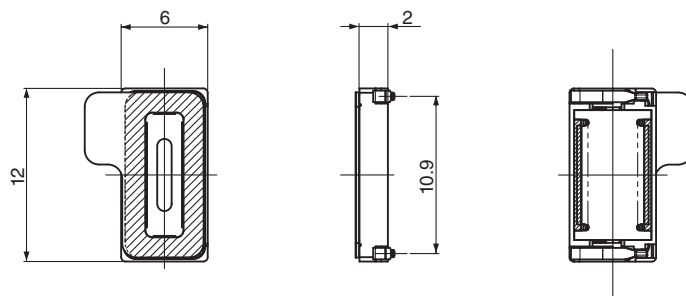

※音響／電気変換素子としてのマイクロホンにおいて、その音響ピックアップ部を振動板と、それと対向する背極板で一種のコンデンサを形成する構造のものを総称して、コンデンサマイクといいます。
音による振動板の動きが、振動板、背極板間の静電容量の変化として取り出されます。
この時通常はコンデンサ成極電圧として、数十V～数百Vを外側から印加する必要がありますが、エレクトレット効果により高分子フィルムに電荷を持続させ、成極用直流高電圧を不要としたものがエレクトレットコンデンサマイクロホンです。
構造的には、エレクトレット用のフィルムをどこに使用しているかで以下の三タイプに分類されます。

- ①ホイルエレクトレットコンデンサマイクロホン
振動板自体が、エレクトレット用的高分子フィルムで出来ているもの。
- ②バックエレクトレットコンデンサマイクロホン
①とは逆に、背極板側に高分子フィルムを溶着したもの。
- ③フロントエレクトレットコンデンサマイクロホン
構造的に背極板をなくし、振動板とマイクカプセル内側自体でコンデンサを形成、エレクトレットはケース内側にあります。

※A microphone as an audio-electric converting device, whose audio pickup section has a structure of a condenser consisting of a diaphragm and a back plate opposite thereto, is called a condenser microphone.

The motion of the diaphragm by sound is picked up as a variation of capacitance between the diaphragm and the back plate.

In this case, usually, a voltage of tens or hundreds of volts should be applied externally as a condenser polarizing voltage. However, electric charge can be maintained in a polymer film by the electret effect, thereby eliminating the polarizing direct-current high voltage. Such is an electret condenser microphone.

In structure, electret condenser microphones are grouped into the following three types according to where the electret film is used:

- ①Foil-type electret condenser microphone
The diaphragm itself is made of an electret polymer film.
- ②Back-type electret condenser microphone
Contrary to ①, a polymer film is adhered to the back plate.
- ③Front-type electret condenser microphone
The back plate is structurally eliminated. The diaphragm and the inside portion of the microphone capsule itself form the condenser. The electret is located inside the case.

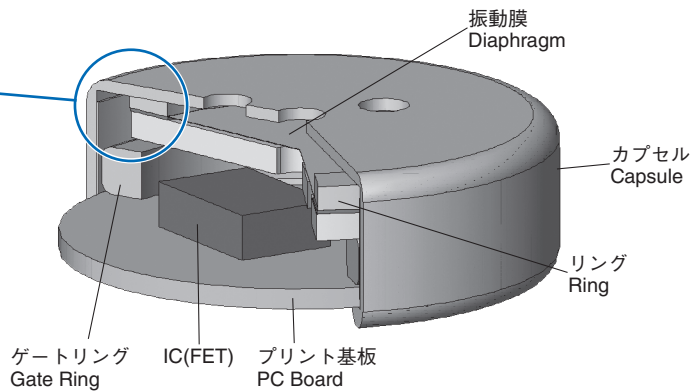
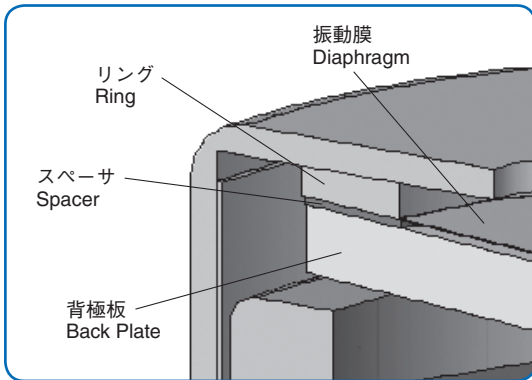

感度

ある一定量 (1 kHz で 1 Pa) の音圧がマイクロホンに加わったとき、そのマイクロホンの出力端子に生ずる開放端電圧を感度と称し、-40 dB/Pa at 1 kHz の様に表します。

$0 \text{ dB} = 1 \text{ V/Pa at } 1 \text{ kHz}$

Sensitivity

The sensitivity is defined as the output voltage for a specified acoustic stimulus and load condition. In this catalog it is expressed in dBV/pa.

In the case of dynamic types it is expressed as the open circuit voltage appearing at the output terminals.

In the case of electret type it is expressed with a specified resistive load and supply voltage since the output resistance tends towards constant current characteristic.

出力インピーダンス

マイクロホンの出力端子側から見たマイクロホン内部の電気抵抗を表わします。
JIS C-5502 の規定では、50Ω、200Ω、250Ω、400Ω、600Ωを標準としています。

尚、エレクトレットコンデンサマイクロホンユニットの場合は、主に負荷抵抗によって定まります。

Output impedance

The output impedance represents the internal electric resistance within a microphone as seen from the side of output terminals of the microphone.

JIS C-5502 specifies 50,200,250,400 and 600 ohms as standard. In the case of ECMs, the effective output resistance is determined mainly by the value of load resistance. It can be made higher or lower by the value of load resistance with a corresponding change in sensitivity.

周波数特性

低音域から高音域まで、どれくらいの周波数の範囲に感度を持っているかを表すデータを周波数特性といいます。言い換えれば、マイクロホンが收音出来る周波数範囲の事で、50 Hz～15 000 Hzのように表します。

Frequency Response

The frequency response of a microphone is the data indicating which frequency range, from the lower to the higher range, the microphone has a certain sensitivity. In other words, it is the frequency range within which the microphone can receive sound. It is expressed as 50 Hz-15000 Hz.

■全指向性／Omnidirectional

Model No.	寸法 Dimensions (mm)	質量 Mass (g)	感度 Sensitivity (dB/Pa)	インピーダンス Impedance (kΩ)	基準電圧 Standard Power Supply (V DC)	消費電流 Current Consumption (mA)	Lead Wire Type	Pin Type	Solderless Type	Solder Reflow Type	チップコンデンサ 内蔵可 Chip- Condenser Built-in available	チップコンデンサ 外付可 Chip- Condenser Soldered is available
KUS0623	∅4 × 1.3	0.07	-43	2.2	2.0	0.5	-	-	-	○	○	-
KUB0623	∅4 × 1.3	0.07	-42	2.2	2.0	0.5	○	-	-	-	○	-
KUB2823	∅6 × 2.7	0.2	-45	2.2	2.0	0.5	○	○	○	-	○	○
KUC3523	∅9.4 × 4.5	0.6	-45	1.0	4.5	0.8	○	○	-	-	○	○
KUC4023	∅9.7 × 6.7	0.9	-45	1.0	4.5	0.8	○	○	-	-	○	○

■単一指向性／Unidirectional

Model No.	寸法 Dimensions (mm)	質量 Mass (g)	感度 Sensitivity (dB/Pa)	インピーダンス Impedance (kΩ)	基準電圧 Standard Power Supply (V DC)	消費電流 Current Consumption (mA)	Lead Wire Type	Pin Type	Solderless Type	チップコンデンサ 内蔵可 Chip- Condenser Built-in available	チップコンデンサ 外付可 Chip- Condenser Soldered is available
KUB9023	∅6 × 2.2	0.21	-45	2.2	2.0	0.5	○	-	-	○	-
KUB8223	∅8 × 4.5	0.7	-45	1.0	4.5	0.5	○	○	-	○	-
KUB8923	∅9.4 × 4.7	1.0	-45	2.2	4.5	0.5	○	-	-	○	-

※KUC：ホイールエレクトレット／Foil Electret KUB：バックエレクトレット／Back Electret KUF：フロントエレクトレット／Front Electret
 KUR：リバース／Reverse KUS：リフロー／Reflow

KUS0623

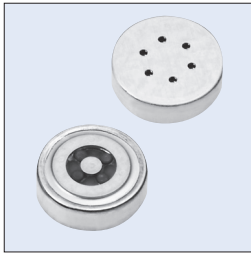

Solder Reflow Type

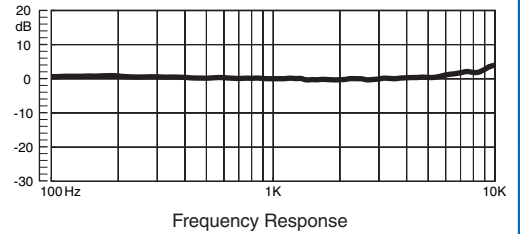
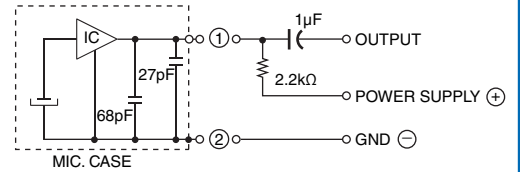
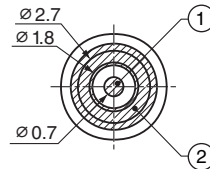
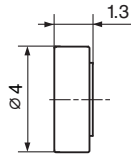

KUB0623



Lead Wire Type

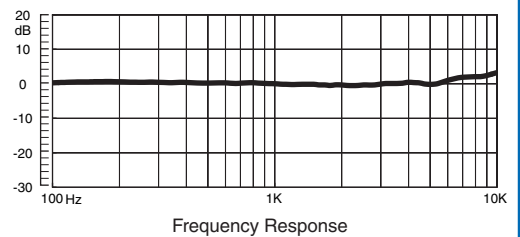
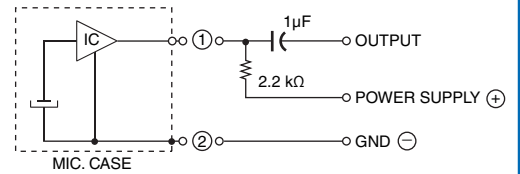
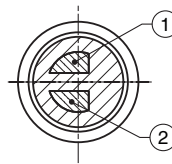
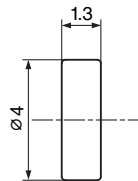

KUB2823

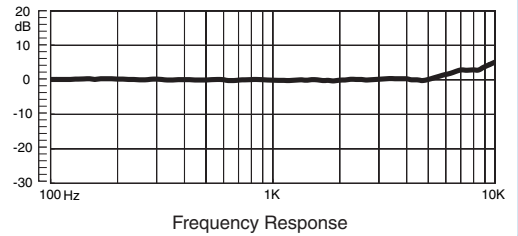
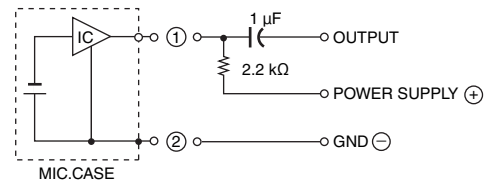
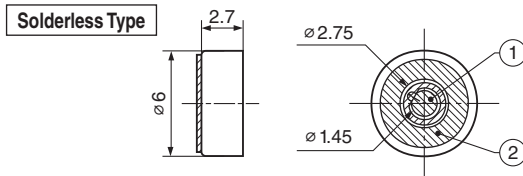
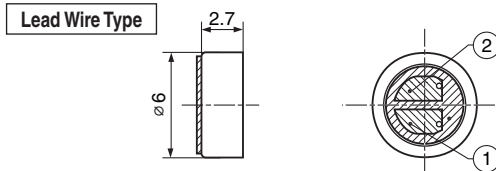
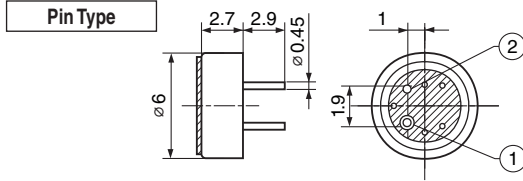

KUC3523

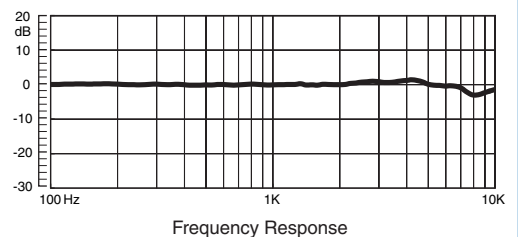
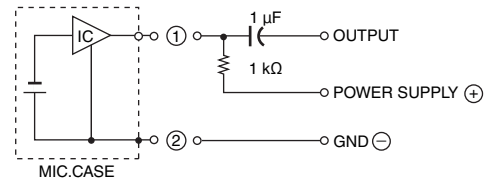
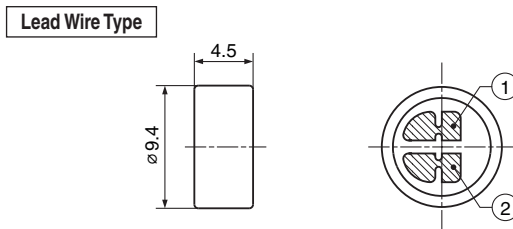
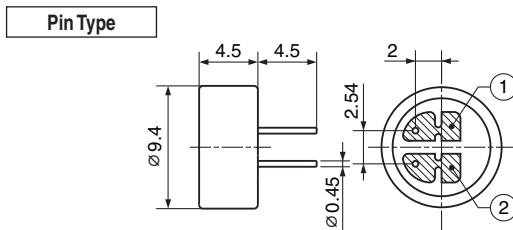
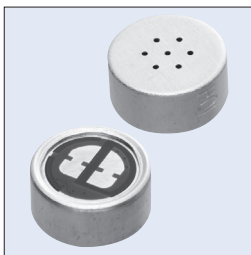

KUC4023

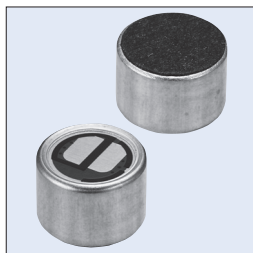

Pin Type

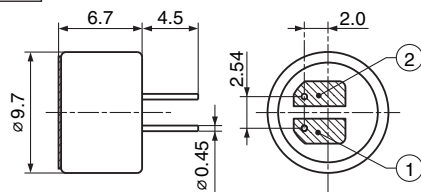

Lead Wire Type

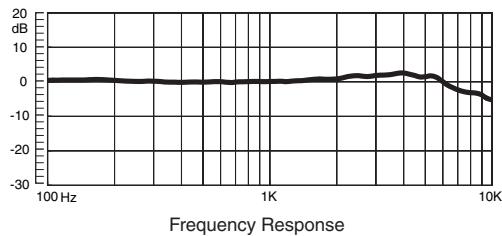
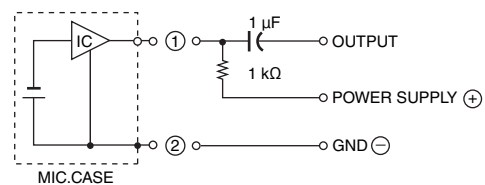
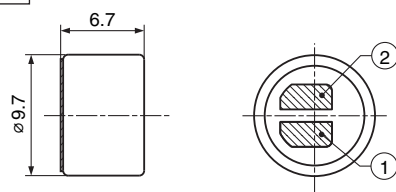

KUB9023



Lead Wire Type

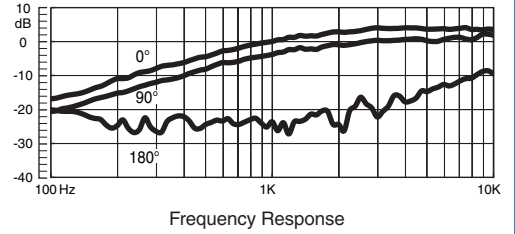
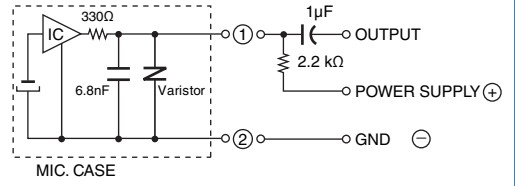
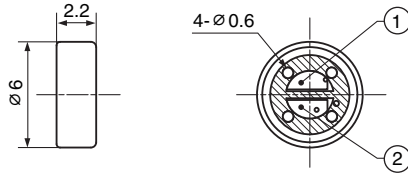

KUB8223

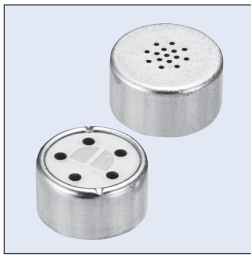

Pin Type

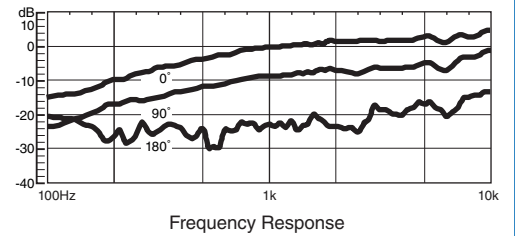
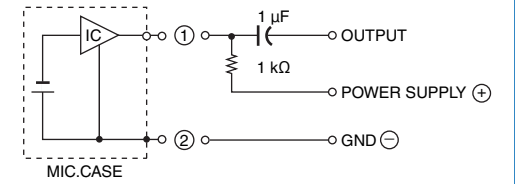
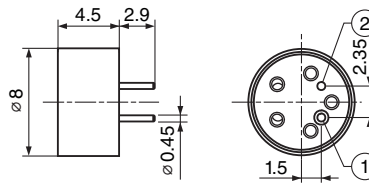

Lead Wire Type

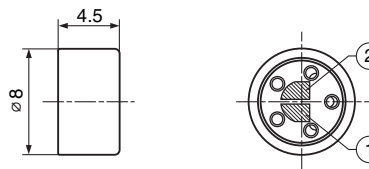

KUB8923



Lead Wire Type

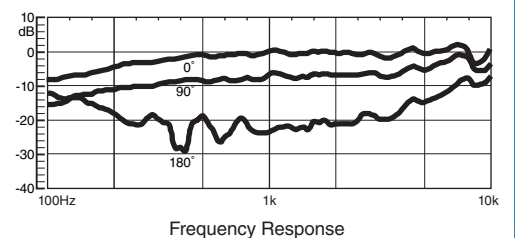
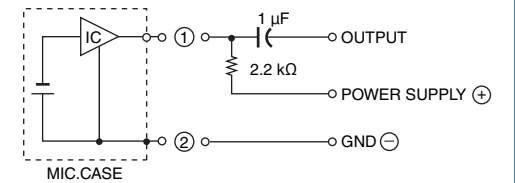
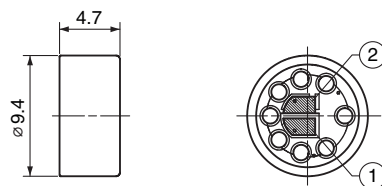

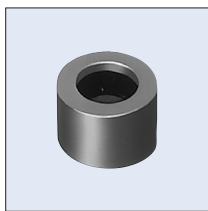

KCU2079

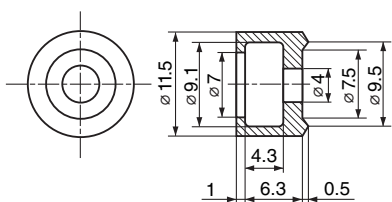

KCU2085

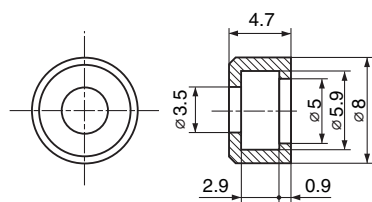

KCU2300

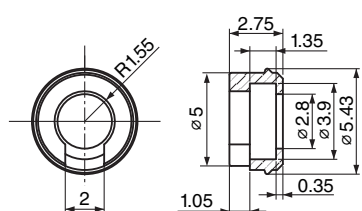

Model No.	感 度 Sensitivity	消費電流 Current Consumption	S/N比 Signal to Noise Ratio	出カインピーダンス Impedance	動作電圧 Operating Voltage	指向性 Directivity
KRM0300	-42 ± 3dB	70µA typ.	59dB typ.	100Ω max.	2.1V (1.5V - 3.3V)	全指向性 Omni - Directional
KRM0500	-42 ± 3dB	70µA typ.	59dB typ.	100Ω max.	2.1V (1.5V - 3.3V)	全指向性 Omni - Directional
KRM5200 通常品	-38 ± 3dB	70µA typ.	62dB typ.	100Ω max.	2.1V (1.5V - 3.3V)	全指向性 Omni - Directional
KRM5200 オフセット品	-42 ± 3dB	70µA typ.	59dB typ.	430Ω max.	2.1V (1.5V - 3.3V)	全指向性 Omni - Directional

Digital MIC

Model No.	感 度 Sensitivity	クロック周波数 Clock Frequency	消費電流 Current Consumption	S/N比 Signal to Noise Ratio	動作電圧 Operating Voltage	指向性 Directivity
KRM5303	-26 ± 3dBFS/Pa	2.4MHz	0.55mA max.	62dB typ.	1.8V (1.64V - 2.86V)	全指向性 Omni - Directional

KRM0300

Ultra-Small type

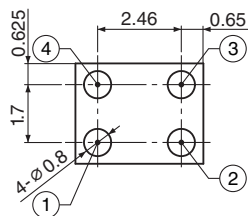
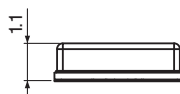
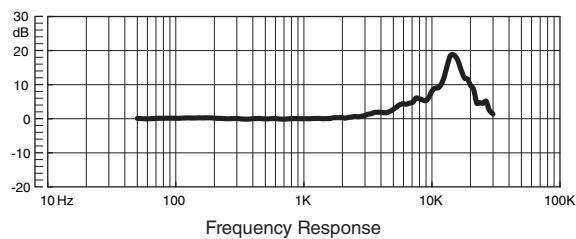
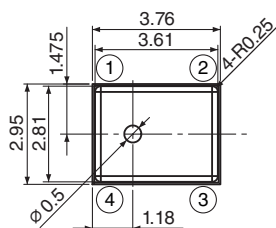
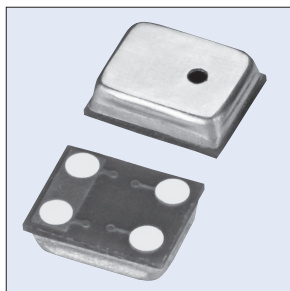

感 度 Sensitivity	-42±3dB
消費電流 Current Consumption	70µA typ.
S/N比 Signal to Noise Ratio	59dB typ.
出力インピーダンス Impedance	100Ω max.
動作電圧 Operating Voltage	2.1V(1.5V-3.3V)
指向性 Directivity	全指向性 Omni - Directional

①	電源 / Power
②	アース / Ground
③	アース / Ground
④	出力 / Output

KRM0500

Ultra-Small type

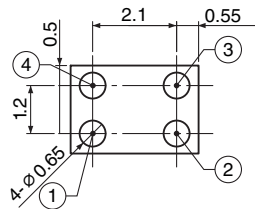
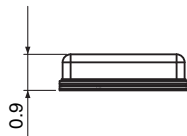
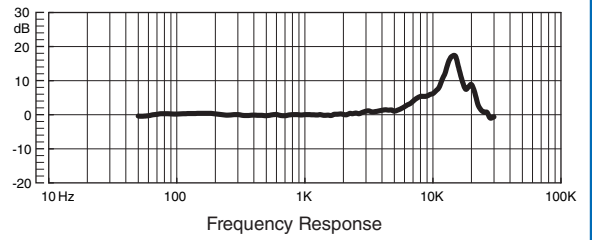
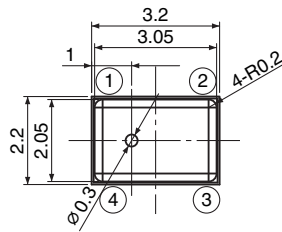
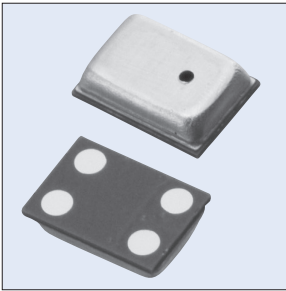

感度 Sensitivity	-42±3dB
消費電流 Current Consumption	70µA typ.
S/N比 Signal to Noise Ratio	59dB typ.
出力インピーダンス Impedance	100Ω max.
動作電圧 Operating Voltage	2.1V(1.5V-3.3V)
指向性 Directivity	全指向性 Omni - Directional

①	電源 / Power
②	アース / Ground
③	アース / Ground
④	出力 / Output

KRM5200

Ultra-Small type

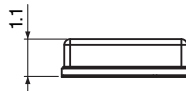
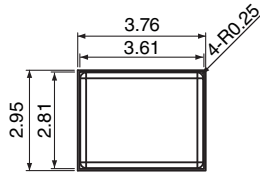
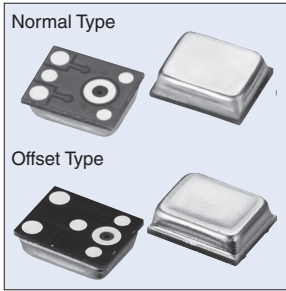

Normal Type

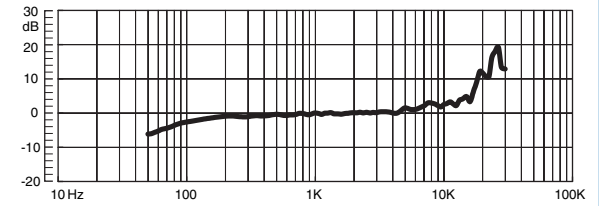

Offset Type

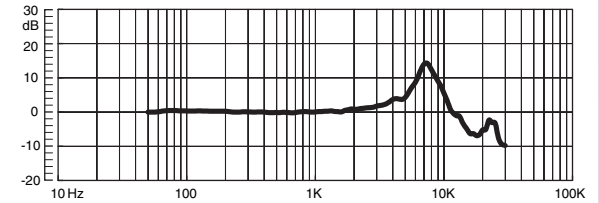

Frequency Response

	通常品 Normal Type	オフセット品 Offset Type
感度 Sensitivity	-38±3dB	-42±3dB
消費電流 Current Consumption	70µA typ.	70µA typ.
S/N比 Signal to Noise Ratio	62dB typ.	59dB typ.
出力インピーダンス Impedance	100Ω max.	430Ω max.
動作電圧 Operating Voltage	2.1V(1.5V-3.3V)	2.1V(1.5V-3.3V)
指向性 Directivity	全指向性 Omni - Directional	全指向性 Omni - Directional

Normal Type

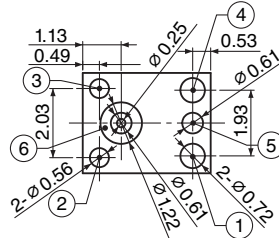

Offset Type

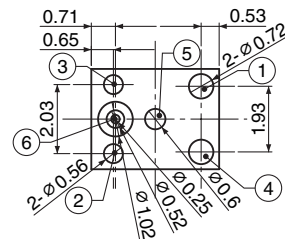

- ① 出力 / Output
- ② アース / Ground
- ③ アース / Ground
- ④ 電源 / Power
- ⑤ アース / Ground
- ⑥ アース / Ground

KRM5303

Digital MIC

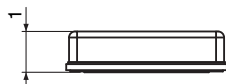
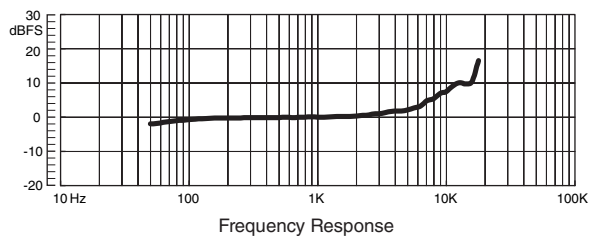
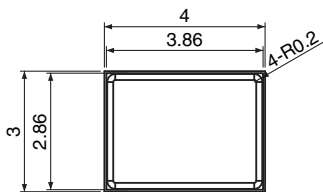
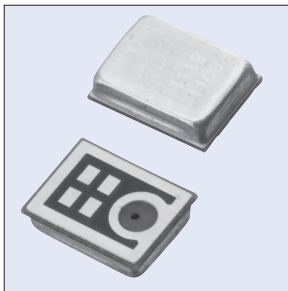

感度 Sensitivity	-26±3dBFS/Pa
クロック周波数 Clock Frequency	2.4MHz
消費電流 Current Consumption	0.55mA max.
S/N比 Signal to Noise Ratio	62dB typ.
動作電圧 Operating Voltage	1.8V(1.64V-2.86V)
指向性 Directivity	全指向性 Omni - Directional

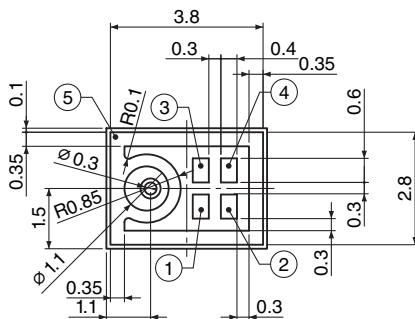

①	セレクト / Sel
②	クロック / Clk
③	電源 / Vs
④	出力 / Data
⑤	アース / GND

■ヘッドホン／Headphones

Model No.	Type	インピーダンス Impedance (Ω)	出力音圧 S. P. L (dB/mW)	定格入力 Nominal Input (mW)	質量 Mass (g)
HDH0281	Dynamic	32	102	1	10.5
HDH0607		-	-	-	-
HRH0616		-	-	-	-

■マイクロホン／Microphones

Model No.	Type	指向性 Directivity	インピーダンス Impedance (Ω)	感 度 Sensitivity (dB/Pa)	SN比 SN Ratio (dB)	最大入力音圧 Maximum Input S.P.L (dB)	コードプラグ Cord Plug	質量 Mass (g)
KHM8962	ECM	単一指向性 Uni directional	2.2K	-40	55	100	3.5DIA 2 Poles	25
KHM0016			1K	-43.5	56	100		30
KHM0023			220	-2.5	60	100	コネクタ	27.5

■Bluetooth®スピーカ／Bluetooth® Speaker

Model No.	Bluetooth Version	連続動作時間 Operation time	質量 Mass
HBG5006	Ver 2.1 + EDR	approx. 5 hours	approx. 130g
HBG5011	Ver 2.1 + EDR	approx. 5 hours	approx. 112g

HDH0281

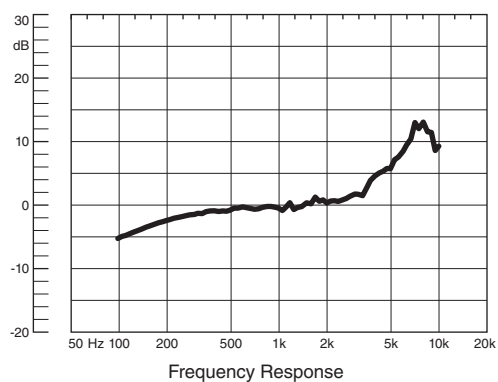
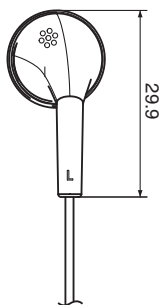

Plug : JIS C 6560

HRH0607

赤外線ヘッドホン／IR Headphone

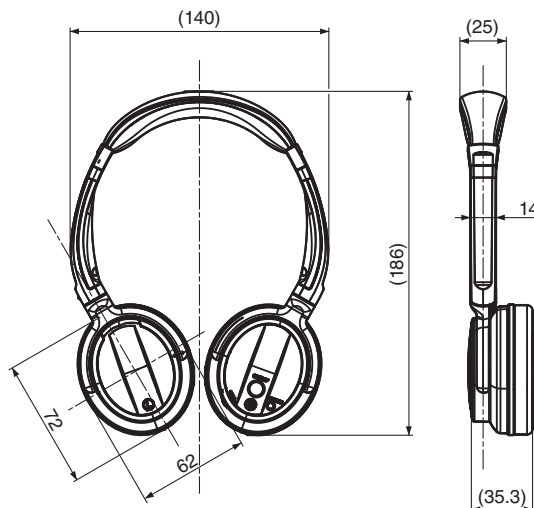

構造 Structure	折りたたみ式 Folded Structure
受信方式 Receiving System	赤外線方式周波数変調 Infrared Frequency Modulation
受信周波数 Receiving Frequency	Lch 2.3MHz ± 30kHz Rch 2.8MHz ± 30kHz
電源電圧／ Supply Voltage	2.4V～3.4V
信号対雑音比 Signal to Noise Ratio	50dB Min.
バッテリー寿命 Battery Life	30h Min.
オートパワーオフ機能 Auto Power Off	3min 45sec ± 15sec (No Audio Signal) 4h ± 15min (Audio Streaming)

HRH0616

赤外線ヘッドホン／IR Headphone

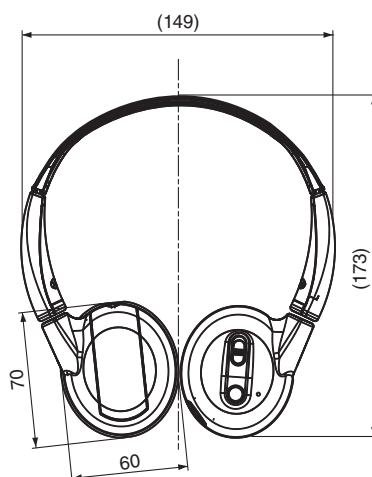

構造／ Structure	折りたたみ式 Folded Structure
受信方式／ Receiving System	赤外線方式周波数変調 Infrared Frequency Modulation
受信周波数／ Receiving Frequency	Ach Lch 2.3MHz ± 30kHz Ach Rch 2.8MHz ± 30kHz Bch Lch 3.2MHz ± 30kHz Bch Rch 3.8MHz ± 30kHz
電源電圧／ Supply Voltage	2.4V～3.4V
信号対雑音比／ Signal to Noise Ratio	50dB Min.
バッテリー寿命／ Battery Life	50h Min.
オートパワーオフ機能／ Auto Power off	3min 45sec ± 15sec (No Modulation Signal) 4h ± 15 min (Audio Streaming)

KHM8962

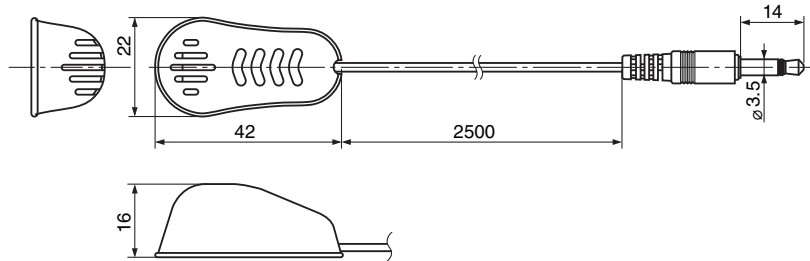

Model No.	KHM8962
指向性 Directivity	単一指向性 Uni-Directional
インピーダンス Impedance	2.2K Ω
感度 Sensitivity	-40 dB
S/N比 SN Ratio	55 dB typ.
最大入力音圧 Maximum Input S.P.L	100 dB
質量 Mass	25 g

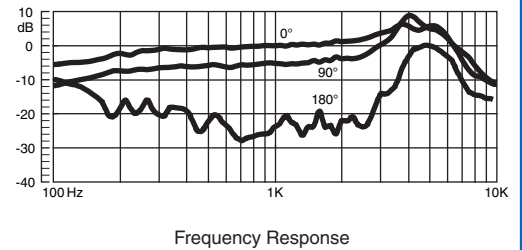

Plug : JIS C 6560

KHM0016

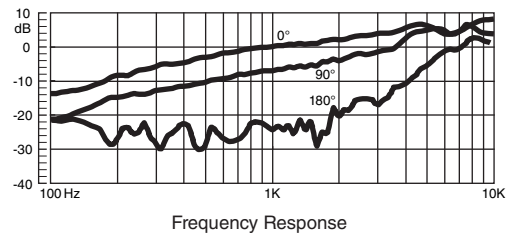
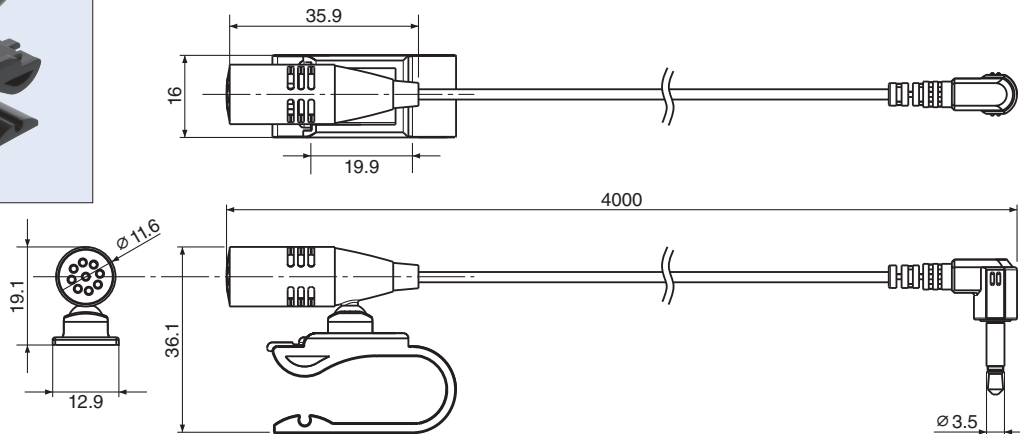

Plug : JIS C 6560

KHM0023

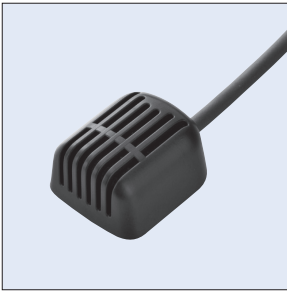

【マイクロホンのみ】

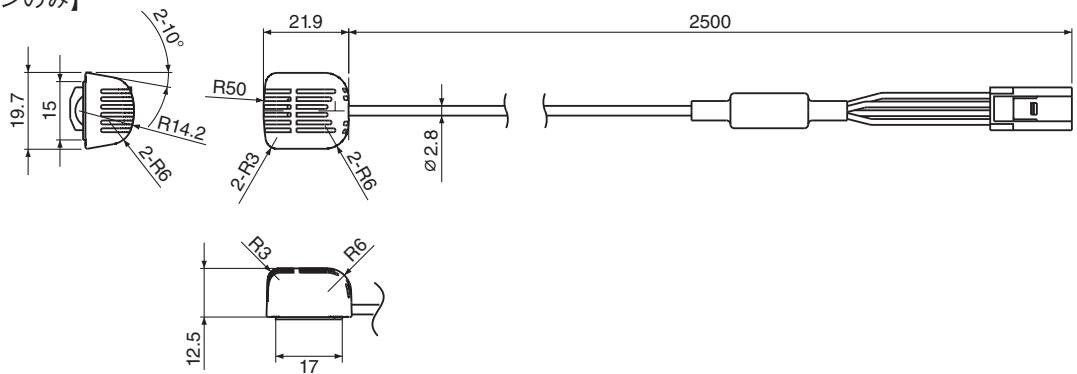

【スイッチ付】

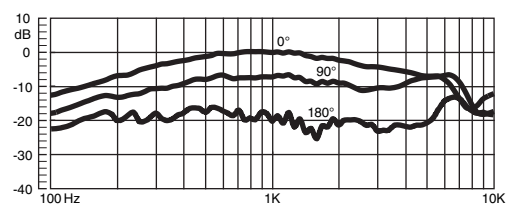
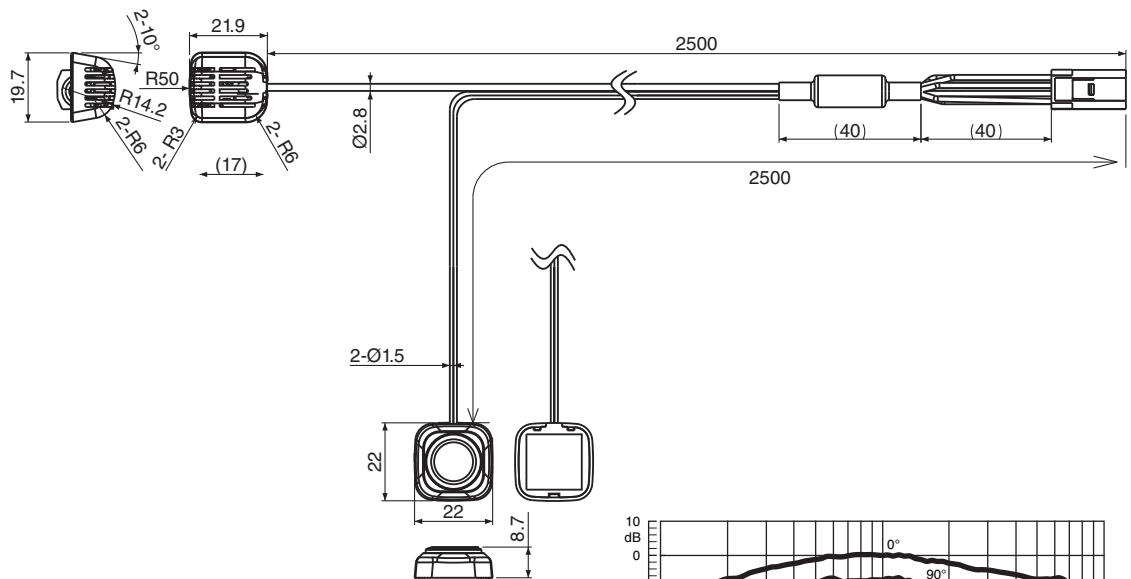

Connector : Tyco Electronics 1376352-1

HBG5006

Bluetooth®ポータブルスピーカ / Bluetooth® Portable Speaker

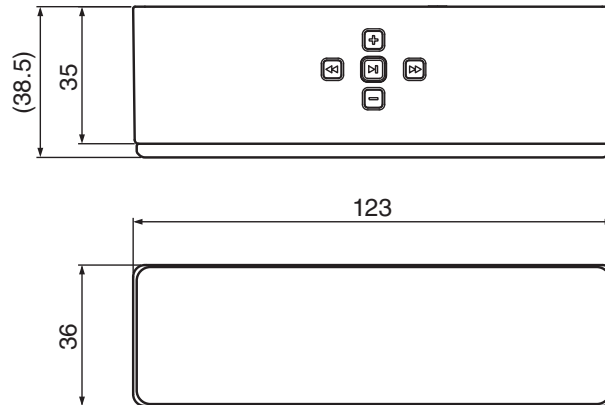

Bluetooth Version	Ver 2.1 + EDR.	
対応プロファイル Supported Profile	HFP ver1.5/HSP ver 1.1/A2DP ver1.2/ AVRCP ver1.0/GAVDP ver1.0	
電池容量 Battery Capacity	400mAh typ.	
連続動作時間 Operation Time	音楽再生時 Music Play Time	approx. 5 hours
	通話時 Talk Time	approx. 5 hours
待ち受け時間 Standby Time	approx. 150 hours	
質量 Mass	approx. 130g	

HBG5011

Bluetooth®薄型防水スピーカ / Bluetooth® Slimline Drip-Proof Speaker

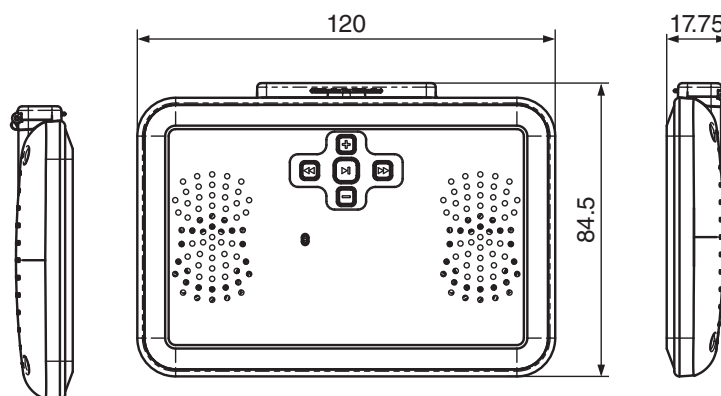

Bluetooth Version	Ver 2.1 + EDR.	
対応プロファイル Supported Profile	HFP ver1.5/HSP ver 1.1/A2DP ver1.2/ AVRCP ver1.0/GAVDP ver1.0	
電池容量 Battery Capacity	400mAh typ.	
連続動作時間 Operation Time	音楽再生時 Music Play Time	approx. 5 hours
	通話時 Talk Time	approx. 5 hours
待ち受け時間 Standby Time	approx. 150 hours	
質量 Mass	approx. 112g	

■無線モジュール／Wireless Transmission Modules

Model No.	製品名 Product name	寸法 Dimensions (mm)	電源電圧 Supply voltage	Bluetooth version	QDID	無線出力電力 RF output power	フラッシュメモリ容量 Capacity of Flash Memory	インターフェイス Interface
HRM1002	Bluetooth module	23 × 12.7 × 2.2 (without Shield Cover)	2.5～4.4 V	Ver.2.1+EDR	B014616	+4dBm typ. (Class 1)	16 Mbit	UART/USB/ Analog audio
HRM1014								UART/USB/ I ² S

Model No.	製品名 Product name	寸法 Dimensions (mm)	電源電圧 Supply voltage	Bluetooth version	QDID FCC TELEC	無線出力電力 RF output power	実装方式 Mounting method	インターフェイス Interface
HRM1017	Bluetooth Low Energy module	12.7 × 23 × 2.6	1.8～3.6 V (3.0 V typ.)	Ver.4.0 (Bluetooth Low Energy/ Single mode)	B020660 VIYHM1017 007-AA0300	+4dBm typ.	Soldering Bump (1.2 mm pitch, 44 terminals)	UART/USB/ I ² S/GPIO

Model No.	製品名 Product name	寸法 Dimensions (mm)	電源電圧 Supply voltage	規格 Standard	通信周波数 Frequency band	変調方式 Modulation method	通信速度 Transmission speed	RF出力 RF output power	インターフェイス Interface
HRM0036	ANT module	12.7 × 23 × 2.6	1.8～3.6 V	ANT	2.4 GHz band (2403-2480 MHz)	GFSK	1 Mbps max.	+4 dBm typ.	UART/SPI/ I ² C/GPIO

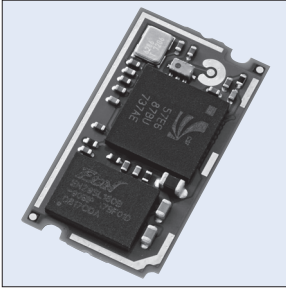
HRM1002 / HRM1014
Bluetooth®モジュール / Bluetooth® Module

Model No.	HRM1002	HRM1014
Bluetooth version	2.1+EDR	
QDID	B014616	
無線出力電力 RF output power	+4 dBm typ. (Class 1)	
寸法 Dimensions	23 × 12.7 × 2.2 (without Shield Cover)	
電源電圧 Supply voltage	2.5 ~ 4.4 V	
インターフェイス Interface	UART/USB/ Analog audio	UART/USB/I ² S
フラッシュメモリー容量 Capacity of Flash Memory	16 Mbit	

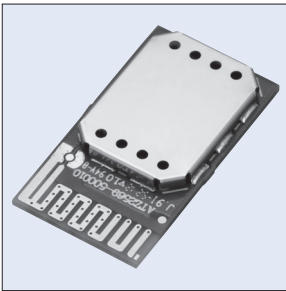
HRM1017
Bluetooth® Low Energyモジュール / Bluetooth® Low Energy Module

Model No.	HRM1017
Bluetooth version	Ver.4.0 (Bluetooth Low Energy/Single mode)
QDID	B020660
無線出力電力 RF output power	+4 dBm typ.
寸法 Dimensions	12.7 × 23 × 2.6
電源電圧 Supply voltage	1.8 ~ 3.6 V (3.0 V typ.)
インターフェイス Interface	UART/USB/I ² S/GPIO
実装方式 Mounting method	Soldering Bump (1.2 mm pitch, 44 terminals)

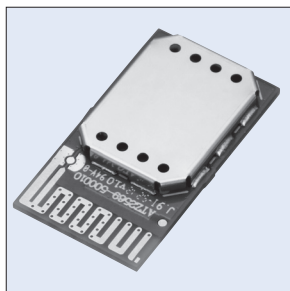
HRM0036
ANTモジュール / ANT Module

Model No.	HRM0036
製品名 / Product name	ANT Module
寸法 / Dimensions	12.7 × 23 × 2.6
電源電圧 / Supply voltage	1.8~3.6 V
規格 / Standard	ANT
通信周波数 / Frequency band	2.4 GHz band (2403-2480 MHz)
変調方式 / Modulation method	GFSK
通信速度 / Transmission speed	1 Mbps max.
無線出力電力 / RF output power	+4 dBm typ
インターフェイス / Interface	UART/SPI/I ² C/GPIO
実装タイプ / Mounting type	Solder bumps (1.2 mm pitch, 44 bumps)

Model No. Table

Model No.	Page						
HBG5006	23	HRM1002	25	KHM0023	22	KUB2823	8
HBG5011	23	HRM1014	25	KHM8962	20	KUB8223	10
HDR2259	18	HRM1017	25	KRM0300	13	KUB8923	10
HRH0607	4	KCU2079	11	KRM5000	14	KUB9023	10
HRH0616	19	KCU2085	11	KRM5200	15	KUC3523	8
HRM0036	19	KCU2300	11	KRM5303	16	KUC4023	9
	26	KHM0016	21	KUB0623	7	KUS0623	7



http://www.hosiden.co.jp

本社

〒581-0071 大阪府八尾市北久宝寺1-4-33
Tel : 072-993-1010 Fax : 072-994-5101

大阪営業統括部

〒581-0071 大阪府八尾市北久宝寺1-4-33
Tel : 072-924-8920 Fax : 072-994-8506

東京営業統括部

〒221-0014 横浜市神奈川区入江1-14-25
Tel : 045-423-2231 Fax : 045-423-2232

欧米営業統括部

〒581-0071 大阪府八尾市北久宝寺1-4-33
Tel : 072-924-8930 Fax : 072-924-8937

アジア営業課

〒581-0071 大阪府八尾市北久宝寺1-4-33
Tel : 072-924-8920 Fax : 072-994-8506

名古屋営業所

〒465-0024 名古屋市名東区本郷2-177 (第3幸楽ビル2-C)
Tel : 052-775-5570 Fax : 052-775-2285

広島営業所

〒730-0043 広島県広島市中区富士見町16-22 (ロアール富士見町6F 603号室)
Tel : 082-545-3536 Fax : 082-541-1237

株式会社 サトレックス

本社

〒537-0025 大阪市東成区中道3-15-16 (毎日東ビル3F)
Tel : 06-6974-3303 Fax : 06-6974-3305

東京営業所

〒221-0014 横浜市神奈川区入江1-14-25 (ホシデン東京支社ビル3F)
Tel : 045-423-6066 Fax : 045-423-6067



http://www.hosiden.com

Head Office

4-33, Kitakyuhoji 1-chome, Yao-city, Osaka 581-0071, Japan
Phone : +81-72-993-1010 Fax : +81-72-994-5101

Japan

Overseas Division :

4-33, Kitakyuhoji 1-chome, Yao-city, Osaka 581-0071, Japan
Phone : +81-72-924-8930 Fax : +81-72-924-8937

China

Hosiden Electronics(Shanghai) Co., Ltd.

Room 802,Kirin Plaza,No.666 Gu Bei Road,Changning District,Shanghai P.R.China
Phone : +86-21-5208-1488 Fax : +86-21-5208-1480

Hosiden (Shenzhen) Co., Ltd.

Room2716, Changping Commercial Building, 99 Honghua Road,
Futian Free Trade Zone, Shenzhen, China
Phone : +86-755-8348-0952 Fax : +86-755-8359-7722

Hong Kong

Hong Kong Hosiden Ltd.

Units 1101-02, 11/F., Stelux House, 698 Prince Edward Road East, San Po Kong, Kowloon, Hong Kong
Phone : +852-23238181 Fax : +852-23520425

Taiwan

Taiwan Hosiden Co., Ltd.

3F., No.34, Sec. 3, Zhongshan N. Rd., Zhongshan Dist., Taipei City 10452, Taiwan
Phone : +886-2-2585-8599 Fax : +886-2-2585-5200

Singapore

Hosiden Singapore Pte. Ltd.

28, Genting, Lane, #05-01, Platinum 28, Singapore 349585
Phone : +65-6296-8100 Fax : +65-6296-8200

Malaysia

Hosiden Corporation(M)Sdn. Bhd.

Lot1,Jalan P/1A,Bangi,Industrial Estate,43650
Bander Baru Bangi, Selangor Darul Ehsan,Malaysia
Phone : +60-3-8925-8655 Fax : +60-3-8926-6122

Thailand

Hosiden (Thailand) Co., Ltd.

43 Thai CC Tower, 16st Fl., Room 163, South Sathorn Rd.,
Kwaeng Yannawa, Khet Sathorn, Bangkok 10120, Thailand
Phone : +66-2-673-9760, 9761 Fax : +66-2-673-9762

Germany

Hosiden Europe GmbH

Graf-Recke-Straße 82, 40239 Düsseldorf, Germany
Phone : +49-211-96493-0 Fax : +49-211-96493-90

U.K.

Hosiden Besson Ltd.

12 St. Joseph's Trading Estate St. Joseph's Close, Hove, East Sussex,
BN3 7EZ, United Kingdom
Phone : +44-1273-860000 Fax : +44-1273-777501

U.S.A.

Hosiden America Corp.

Head Office

120 East State Parkway, Schaumburg, IL, 60173, U.S.A.
Phone : +1-847-885-8870 Fax : +1-847-885-0063

San Jose Sales Office

1275 South Winchester Boulevard, Suite G, San Jose, CA 95128, U.S.A.
Phone : +1-408-985-8760 Fax : +1-408-985-8785

Detroit Sales Office

28970 Cabot Drive, Suite 600, Novi, MI 48377, U.S.A.
Phone : +1-248-489-0174 Fax : +1-248-489-1154

- ・製品の改良などにより、当カタログの記載内容を予告無く変更する場合があります。また、当カタログに掲載された製品は予告なく製造中止することがあります。
- ・当カタログの掲載製品は全てRoHS指令に適合しています。
- ・The contents described in this catalog may be changed without prior notice due to products improvements or discontinuance of production.
- ・Every product in this catalog is compliant to RoHS directive.

⚠ 安全に関するご注意

ご使用の際は、納入仕様書を確認の上、正しくお使いください。

⚠ CAUTION FOR SAFETY

Please use our products properly based on our Drawing and Specification.