



# Low-Power, Precision SINGLE-SUPPLY OPERATIONAL AMPLIFIERS

## FEATURES

- **WIDE SUPPLY RANGE:**  
Single Supply:  $V_S = +2.7V$  to  $+36V$   
Dual Supply:  $V_S = \pm 1.35V$  to  $\pm 18V$
- **SPECIFIED PERFORMANCE:**  
 $+2.7V$ ,  $+5V$ , and  $\pm 15V$
- **LOW QUIESCENT CURRENT:**  $250\mu A/amp$
- **LOW INPUT BIAS CURRENT:**  $25nA$  max
- **LOW OFFSET VOLTAGE:**  $100\mu V$  max
- **HIGH CMRR, PSRR, and  $A_{OL}$**
- **SINGLE, DUAL, and QUAD VERSIONS**

## DESCRIPTION

The OPA234 series low-cost op amps are ideal for single-supply, low-voltage, low-power applications. The series provides lower quiescent current than older "1013"-type products and comes in current industry-standard packages and pinouts. The combination of low offset voltage, high common-mode rejection, high power-supply rejection, and a wide supply range provides excellent accuracy and versatility. Single, dual, and quad versions have identical specifications for maximum design flexibility. These general-purpose op amps are ideal for portable and battery-powered applications.

The OPA234 series op amps operate from either single or dual supplies. In single-supply operation, the input common-mode range extends below ground and the output can swing to within 50mV of ground. Excellent phase margin makes the OPA234 series ideal for demanding applications, including high load capacitance. Dual and quad designs feature completely independent circuitry for lowest crosstalk and freedom from interaction.

Single version packages are in an SO-8 surface-mount and a space-saving MSOP-8 surface-mount. Dual packages are in an SO-8 surface-mount. Quad packages are in an SO-14 surface-mount. All are specified for  $-40^\circ C$  to  $+85^\circ C$  operation.

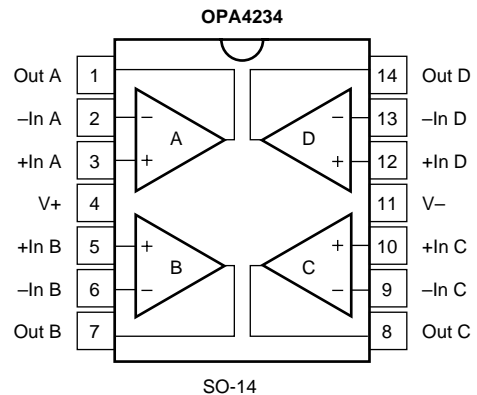
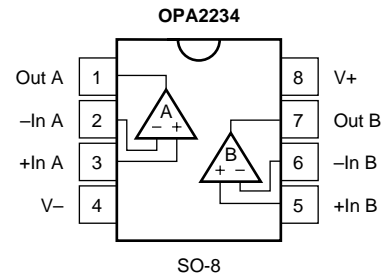
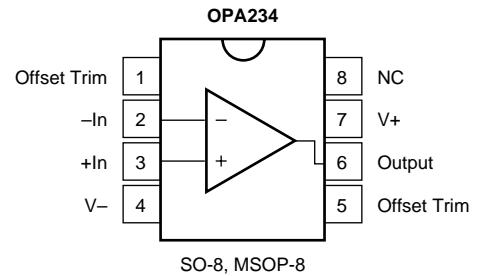

Please be aware that an important notice concerning availability, standard warranty, and use in critical applications of Texas Instruments semiconductor products and disclaimers thereto appears at the end of this data sheet.

All trademarks are the property of their respective owners.

# ELECTRICAL CHARACTERISTICS: $V_S = +5V$

At  $T_A = 25^\circ C$ ,  $V_S = +5V$ ,  $R_L = 10k\Omega$  connected to  $V_S/2$ , and  $V_{OUT} = V_S/2$ , unless otherwise noted.

| PARAMETER   | CONDITION                            | OPA234U, E<br>OPA2234U   |   |  | OPA234UA, EA<br>OPA2234UA<br>OPA4234UA, U |                                |  | UNITS  |
|---|--------------------------------------|--|---|--|---|--------------------------------|--|--|
|   |                                      | MIN  | TYP   | MAX  | MIN                                       | TYP                            | MAX  |  |
| <b>OFFSET VOLTAGE</b><br>Input Offset Voltage<br>OPA234E, EA<br>vs Temperature <sup>(1)</sup><br>vs Power Supply<br>vs Time<br>Channel Separation (Dual, Quad)                                  | $V_{OS}$<br><br>$dV_{OS}/dT$<br>PSRR | $V_{CM} = 2.5V$<br><br>Operating Temperature Range<br>$V_S = +2.7V$ to $+30V$ , $V_{CM} = 1.7V$  | <br>$\pm 40$<br>$\pm 100$<br>$\pm 0.5$<br>3<br>0.2<br>0.3 | <br>$\pm 100$<br>$\pm 150$<br>$\pm 3$<br>10                      |   | <br>*<br>*<br>*<br>*<br>*<br>* | <br>$\pm 250$<br>$\pm 350$<br>*<br>*<br>20 | <br>$\mu V$<br>$\mu V$<br>$\mu V/^\circ C$<br>$\mu V/V$<br>$\mu V/mo$<br>$\mu V/V$   |
| <b>INPUT BIAS CURRENT</b><br>Input Bias Current <sup>(2)</sup><br>Input Offset Current  | $I_B$<br>$I_{OS}$                    | $V_{CM} = 2.5V$<br>$V_{CM} = 2.5V$   | <br>-15<br>$\pm 1$  | <br>-30<br>$\pm 5$   |   | <br>*<br>*                     | <br>-50<br>*                               | <br>nA<br>nA   |
| <b>NOISE</b><br>Input Voltage Noise Density<br>Current Noise Density  | $v_n$<br>$i_n$                       | $f = 1kHz$   | <br>25<br>80  |  |   | <br>*<br>*                     |  | <br>$nV/\sqrt{Hz}$<br>$fA/\sqrt{Hz}$   |
| <b>INPUT VOLTAGE RANGE</b><br>Common-Mode Voltage Range<br>Common-Mode Rejection  | CMRR                                 | $V_{CM} = -0.1V$ to $4V$   | <br>-0.1<br>91  | <br>106  | <br>(V+) -1                               | <br>*<br>86                    | <br>*<br>*                                 | <br>V<br>dB  |
| <b>INPUT IMPEDANCE</b><br>Differential<br>Common-Mode   |                                      | $V_{CM} = 2.5V$  |   | $10^7 \parallel 5$<br>$10^{10} \parallel 6$                      |   | <br>*<br>*                     |  | <br>$\Omega \parallel pF$<br>$\Omega \parallel pF$   |
| <b>OPEN-LOOP GAIN</b><br>Open-Loop Voltage Gain   | $A_{OL}$                             | $V_O = 0.25V$ to $4V$<br>$R_L = 10k\Omega$<br>$R_L = 2k\Omega$   | <br>108<br>86   | <br>120<br>96  |   | <br>100<br>*                   | <br>*<br>*                                 | <br>dB<br>dB   |
| <b>FREQUENCY RESPONSE</b><br>Gain-Bandwidth Product<br>Slew Rate<br>Settling Time: 0.1%<br>0.01%<br>Overload Recovery Time  | GBW<br>SR                            | $C_L = 100pF$<br><br>$G = 1$ , 3V Step, $C_L = 100pF$<br>$G = 1$ , 3V Step, $C_L = 100pF$<br>( $V_{IN}$ ) (Gain) = $V_S$                   | <br>0.35<br>0.2<br>15<br>25<br>16                         |  |   | <br>*<br>*<br>*<br>*<br>*      |  | <br>MHz<br>V/ $\mu s$<br>$\mu s$<br>$\mu s$<br>$\mu s$   |
| <b>OUTPUT</b><br>Voltage Output: Positive<br>Negative<br>Positive<br>Negative<br>Short-Circuit Current<br>Capacitive Load Drive (Stable Operation) <sup>(3)</sup>                               | $I_{SC}$                             | $R_L = 10k\Omega$ to $V_S/2$<br>$R_L = 10k\Omega$ to $V_S/2$<br>$R_L = 10k\Omega$ to Ground<br>$R_L = 10k\Omega$ to Ground<br><br>$G = +1$ | <br>(V+) -1<br>0.25<br>(V+) -1<br>0.1                     | <br>(V+) -0.65<br>0.05<br>(V+) -0.65<br>0.05<br>$\pm 11$<br>1000 |   | <br>*<br>*<br>*<br>*<br>*<br>* | <br>*<br>*<br>*<br>*<br>*<br>*             | <br>V<br>V<br>V<br>V<br>mA<br>pF   |
| <b>POWER SUPPLY</b><br>Specified Operating Voltage<br>Operating Voltage Range<br>Quiescent Current (per amplifier)  | $I_Q$                                | $I_O = 0$  | <br>+2.7  | <br>+5<br>250  | <br>+36<br>300                            | <br>*<br>*                     | <br>*<br>*                                 | <br>V<br>V<br>$\mu A$  |
| <b>TEMPERATURE RANGE</b><br>Specified Range<br>Operating Range<br>Storage<br>Thermal Resistance<br>8-Pin DIP<br>SO-8 Surface-Mount<br>MSOP-8 Surface-Mount<br>14-Pin DIP<br>SO-14 Surface-Mount | $\theta_{JA}$                        |  | <br>-40<br>-40<br>-55                                     |  | <br>+85<br>+125<br>+125                   | <br>*<br>*<br>*                | <br>*<br>*<br>*                            | <br>$^\circ C$<br>$^\circ C$<br>$^\circ C$<br>$^\circ C/W$<br>$^\circ C/W$<br>$^\circ C/W$<br>$^\circ C/W$<br>$^\circ C/W$ |

\* Specifications same as OPA234U, E.

NOTES: (1) Wafer-level tested to 95% confidence level. (2) Positive conventional current flows into the input terminals. (3) See *Small-Signal Overshoot vs Load Capacitance* typical curve.

# ELECTRICAL CHARACTERISTICS: $V_S = +2.7V$

At  $T_A = 25^\circ C$ ,  $V_S = +2.7V$ ,  $R_L = 10k\Omega$  connected to  $V_S/2$ , and  $V_{OUT} = V_S/2$ , unless otherwise noted.

| PARAMETER   | CONDITION     | OPA234U, E<br>OPA2234U   |            |                       | OPA234UA, EA<br>OPA2234UA<br>OPA4234UA, U |           |           | UNITS                 |
|---|---------------|--|------------|-----------------------|---|-----------|-----------|-----------------------|
|   |               | MIN  | TYP        | MAX                   | MIN                                       | TYP       | MAX       |                       |
| <b>OFFSET VOLTAGE</b>                                   |               |  |            |                       |   |           |           |                       |
| Input Offset Voltage<br>OPA234E, EA                     | $V_{OS}$      |  | $\pm 40$   | $\pm 100$             |   | *         | $\pm 250$ | $\mu V$               |
| vs Temperature <sup>(1)</sup>                           | $dV_{OS}/dT$  |  | $\pm 100$  | $\pm 150$             |   | *         | $\pm 350$ | $\mu V$               |
| vs Power Supply   | PSRR          |  | $\pm 0.5$  | $\pm 3$               |   | *         | *         | $\mu V/^\circ C$      |
| vs Time   |               |  | 3          | 10                    |   | *         | 20        | $\mu V/V$             |
| Channel Separation (Dual, Quad)                         |               |  | 0.2        |                       |   | *         |           | $\mu V/mo$            |
|   |               |  | 0.3        |                       |   | *         |           | $\mu V/V$             |
| <b>INPUT BIAS CURRENT</b>                               |               |  |            |                       |   |           |           |                       |
| Input Bias Current <sup>(2)</sup>                       | $I_B$         | $V_{CM} = 1.35V$   | -15        | -30                   |   | *         | -50       | nA                    |
| Input Offset Current                                    | $I_{OS}$      | $V_{CM} = 1.35V$   | $\pm 1$    | $\pm 5$               |   | *         | *         | n                     |
| <b>NOISE</b>  |               | $f = 1kHz$   |            |                       |   |           |           |                       |
| Input Voltage Noise Density                             | $V_n$         |  | 25         |                       |   | *         |           | $nV/\sqrt{Hz}$        |
| Current Noise Density                                   | $i_n$         |  | 80         |                       |   | *         |           | $fA/\sqrt{Hz}$        |
| <b>INPUT VOLTAGE RANGE</b>                              |               |  |            |                       |   |           |           |                       |
| Common-Mode Voltage Range                               |               |  | -0.1       |                       | $(V+) - 1$                                | *         | *         | V                     |
| Common-Mode Rejection                                   | CMRR          | $V_{CM} = -0.1V$ to $1.7V$                                       | 91         | 106                   |   | *         | *         | dB                    |
| <b>INPUT IMPEDANCE</b>                                  |               |  |            |                       |   |           |           |                       |
| Differential  |               | $V_{CM} = 1.35V$   |            | $10^7 \parallel 5$    |   | *         |           | $\Omega \parallel pF$ |
| Common-Mode   |               |  |            | $10^{10} \parallel 6$ |   | *         |           | $\Omega \parallel pF$ |
| <b>OPEN-LOOP GAIN</b>                                   |               |  |            |                       |   |           |           |                       |
| Open-Loop Voltage Gain                                  | $A_{OL}$      | $V_O = 0.25V$ to $1.7V$<br>$R_L = 10k\Omega$<br>$R_L = 2k\Omega$ | 108<br>86  | 125<br>96             |   | 100<br>86 | *         | dB<br>dB              |
| <b>FREQUENCY RESPONSE</b>                               |               |  |            |                       |   |           |           |                       |
| Gain-Bandwidth Product                                  | GBW           | $C_L = 100pF$  |            | 0.35                  |   |           | *         | MHz                   |
| Slew Rate   | SR            |  |            | 0.2                   |   |           | *         | $V/\mu s$             |
| Settling Time: 0.1%                                     |               | $G = 1, 1V$ Step, $C_L = 100pF$                                  |            | 6                     |   |           | *         | $\mu s$               |
| 0.01%   |               | $G = 1, 1V$ Step, $C_L = 100pF$                                  |            | 16                    |   |           | *         | $\mu s$               |
| Overload Recovery Time                                  |               | $(V_{IN})$ (Gain) = $V_S$  |            | 8                     |   |           | *         | $\mu s$               |
| <b>OUTPUT</b>   |               |  |            |                       |   |           |           |                       |
| Voltage Output: Positive                                |               | $R_L = 10k\Omega$ to $V_S/2$                                     | $(V+) - 1$ | $(V+) - 0.6$          |   | *         | *         | V                     |
| Negative  |               | $R_L = 10k\Omega$ to $V_S/2$                                     | 0.25       | 0.05                  |   | *         | *         | V                     |
| Positive  |               | $R_L = 10k\Omega$ to Ground                                      | $(V+) - 1$ | $(V+) - 0.65$         |   | *         | *         | V                     |
| Negative  |               | $R_L = 10k\Omega$ to Ground                                      | 0.1        | 0.05                  |   | *         | *         | V                     |
| Short-Circuit Current                                   | $I_{SC}$      |  |            | $\pm 8$               |   | *         | *         | mA                    |
| Capacitive Load Drive (Stable Operation) <sup>(3)</sup> |               | $G = +1$   |            | 1000                  |   | *         | *         | pF                    |
| <b>POWER SUPPLY</b>                                     |               |  |            |                       |   |           |           |                       |
| Specified Operating Voltage                             |               |  | +2.7       | +2.7                  |   | *         | *         | V                     |
| Operating Voltage Range                                 |               |  |            |                       | +36                                       | *         | *         | V                     |
| Quiescent Current (per amplifier)                       | $I_Q$         | $I_O = 0$  |            | 250                   | 300                                       | *         | *         | $\mu A$               |
| <b>TEMPERATURE RANGE</b>                                |               |  |            |                       |   |           |           |                       |
| Specified Range   |               |  | -40        |                       | +85                                       | *         | *         | $^\circ C$            |
| Operating Range   |               |  | -40        |                       | +125                                      | *         | *         | $^\circ C$            |
| Storage   |               |  | -55        |                       | +125                                      | *         | *         | $^\circ C$            |
| Thermal Resistance                                      | $\theta_{JA}$ |  |            |                       |   |           |           |                       |
| 8-Pin DIP   |               |  |            | 100                   |   |           | *         | $^\circ C/W$          |
| SO-8 Surface-Mount                                      |               |  |            | 150                   |   |           | *         | $^\circ C/W$          |
| MSOP-8 Surface-Mount                                    |               |  |            | 220                   |   |           | *         | $^\circ C/W$          |
| 14-Pin DIP  |               |  |            | 80                    |   |           | *         | $^\circ C/W$          |
| SO-14 Surface-Mount                                     |               |  |            | 110                   |   |           | *         | $^\circ C/W$          |

\* Specifications same as OPA234U, E.

NOTES: (1) Wafer-level tested to 95% confidence level. (2) Positive conventional current flows into the input terminals. (3) See *Small-Signal Overshoot vs Load Capacitance* typical curve.

# ELECTRICAL CHARACTERISTICS: $V_S = \pm 15V$

At  $T_A = 25^\circ C$ ,  $V_S = \pm 15V$ , and  $R_L = 10k\Omega$  connected to ground, unless otherwise noted.

| PARAMETER   | CONDITION                              | OPA234U, E<br>OPA2234U   |                      |   | OPA234UA, EA<br>OPA2234UA<br>OPA4234UA, U |             |                              | UNITS                             |  |
|---|--|--|----------------------|---|---|-------------|------------------------------|-----------------------------------|--|
|   |  | MIN  | TYP                  | MAX   | MIN                                       | TYP         | MAX                          |                                   |  |
| <b>OFFSET VOLTAGE</b><br>Input Offset Voltage<br>OPA4234U Model<br>vs Temperature <sup>(1)</sup><br>vs Power Supply<br>vs Time<br>Channel Separation (Dual, Quad)                               | $V_{OS}$<br><br>$dV_{OS}/dT$<br>$PSRR$ | $V_{CM} = 0V$<br><br>Operating Temperature Range<br>$V_S = \pm 1.35V$ to $\pm 18V$ , $V_{CM} = 0V$                         |                      | $\pm 70$<br>$\pm 0.5$<br>3<br>0.2<br>0.3    | $\pm 250$<br>$\pm 5$<br>10                |             | *<br>$\pm 70$<br>*<br>*<br>* | $\pm 500$<br>$\pm 250$<br>*<br>20 | $\mu V$<br>$\mu V$<br>$\mu V/^\circ C$<br>$\mu V/V$<br>$\mu V/mo$<br>$\mu V/V$   |
| <b>INPUT BIAS CURRENT</b><br>Input Bias Current <sup>(2)</sup><br>Input Offset Current  | $I_B$<br>$I_{OS}$                      | $V_{CM} = 0V$<br>$V_{CM} = 0V$   |                      | -12<br>$\pm 1$                              | -25<br>$\pm 5$                            |             | *<br>*                       | -50<br>*                          | nA<br>nA   |
| <b>NOISE</b><br>Input Voltage Noise Density<br>Current Noise Density  | $V_n$<br>$i_n$                         | $f = 1kHz$   |                      | 25<br>80                                    |   |             | *<br>*                       |                                   | $nV/\sqrt{Hz}$<br>$fA/\sqrt{Hz}$   |
| <b>INPUT VOLTAGE RANGE</b><br>Common-Mode Voltage Range<br>Common-Mode Rejection  | CMRR                                   | $V_{CM} = -15V$ to $14V$   | (V-)<br>91           | 106   | (V+) -1                                   | *<br>86     | *<br>*                       | *<br>*                            | V<br>dB  |
| <b>INPUT IMPEDANCE</b><br>Differential<br>Common-Mode   |  | $V_{CM} = 0V$  |                      | $10^7 \parallel 5$<br>$10^{10} \parallel 6$ |   |             | *<br>*                       |                                   | $\Omega \parallel pF$<br>$\Omega \parallel pF$   |
| <b>OPEN-LOOP GAIN</b><br>Open-Loop Voltage Gain   | $A_{OL}$                               | $V_O = -14.5V$ to $14V$  | 110                  | 120   |   | 100         | *                            |                                   | dB   |
| <b>FREQUENCY RESPONSE</b><br>Gain-Bandwidth Product<br>Slew Rate<br>Settling Time: 0.1%<br>0.01%<br>Overload Recovery Time  | GBW<br>SR                              | $C_L = 100pF$<br><br>$G = 1$ , 10V Step, $C_L = 100pF$<br>$G = 1$ , 10V Step, $C_L = 100pF$<br>( $V_{IN}$ ) (Gain) = $V_S$ |                      | 0.35<br>0.2<br>41<br>47<br>22               |   |             | *<br>*<br>*<br>*<br>*        |                                   | MHz<br>V/ $\mu s$<br>$\mu s$<br>$\mu s$<br>$\mu s$   |
| <b>OUTPUT</b><br>Voltage Output: Positive<br>Negative<br>Short-Circuit Current<br>Capacitive Load Drive (Stable Operation) <sup>(3)</sup>   | $I_{SC}$                               | $G = +1$   | (V+) -1<br>(V-) +0.5 | (V+) -0.7<br>(V-) +0.15<br>$\pm 22$<br>1000 |   | *<br>*      | *<br>*<br>*<br>*             |                                   | V<br>V<br>mA<br>pF   |
| <b>POWER SUPPLY</b><br>Specified Operating Voltage<br>Operating Voltage Range<br>Quiescent Current (per amplifier)  | $I_Q$                                  | $I_O = 0$  | $\pm 1.35$           | $\pm 15$<br>$\pm 275$                       | $\pm 18$<br>$\pm 350$                     | *<br>*      | *<br>*                       | *<br>*                            | V<br>V<br>$\mu A$  |
| <b>TEMPERATURE RANGE</b><br>Specified Range<br>Operating Range<br>Storage<br>Thermal Resistance<br>8-Pin DIP<br>SO-8 Surface-Mount<br>MSOP-8 Surface-Mount<br>14-Pin DIP<br>SO-14 Surface-Mount | $\theta_{JA}$                          |  | -40<br>-40<br>-55    |   | +85<br>+125<br>+125                       | *<br>*<br>* | *<br>*<br>*                  | *<br>*<br>*                       | $^\circ C$<br>$^\circ C$<br>$^\circ C$<br>$^\circ C/W$<br>$^\circ C/W$<br>$^\circ C/W$<br>$^\circ C/W$<br>$^\circ C/W$ |

\* Specifications same as OPA234U, E.

NOTES: (1) Wafer-level tested to 95% confidence level. (2) Positive conventional current flows into the input terminals. (3) See *Small-Signal Overshoot vs Load Capacitance* typical curve.



# ELECTROSTATIC DISCHARGE SENSITIVITY

This integrated circuit can be damaged by ESD. Texas Instruments recommends that all integrated circuits be handled with appropriate precautions. Failure to observe proper handling and installation procedures can cause damage.

ESD damage can range from subtle performance degradation to complete device failure. Precision integrated circuits may be more susceptible to damage because very small parametric changes could cause the device not to meet its published specifications.

## PACKAGE INFORMATION

| PRODUCT   | PACKAGE  | PACKAGE MARKING                 |
|---|--|---------------------------------|
| <b>Single</b><br>OPA234EA<br>OPA234E<br>OPA234UA<br>OPA234U | MSOP-8 Surface-Mount<br>"<br>SO-8 Surface-Mount<br>" | A34<br>"<br>OPA234UA<br>OPA234U |
| <b>Dual</b><br>OPA2234UA<br>OPA2234U                        | SO-8 Surface-Mount<br>"                              | OPA2234UA<br>OPA2234U           |
| <b>Quad</b><br>OPA4234UA<br>OPA4234U                        | SO-8 Surface-Mount<br>"                              | OPA4234UA<br>OPA4234U           |

NOTE: (1) For the most current package and ordering information, see the Package Option Addendum located at the end of this data sheet.

## ABSOLUTE MAXIMUM RATINGS

|   |                          |
|---|--------------------------|
| Supply Voltage, V+ to V- .....            | 36V                      |
| Input Voltage .....                       | (V-) -0.7V to (V+) +0.7V |
| Output Short-Circuit <sup>(1)</sup> ..... | Continuous               |
| Operating Temperature .....               | -40°C to +125°C          |
| Storage Temperature .....                 | -55°C to +125°C          |
| Junction Temperature .....                | 150°C                    |
| Lead Temperature (soldering, 10s) .....   | 300°C                    |

NOTE: (1) Short-circuit to ground, one amplifier per package.

# TYPICAL CHARACTERISTIC CURVES

At  $T_A = +25^\circ\text{C}$  and  $R_L = 10\text{k}\Omega$ , unless otherwise noted.

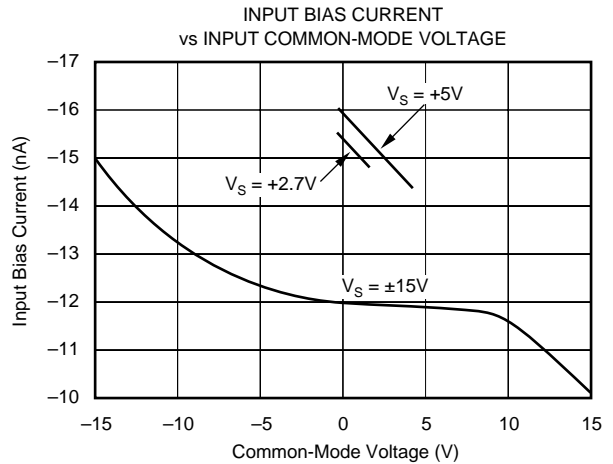
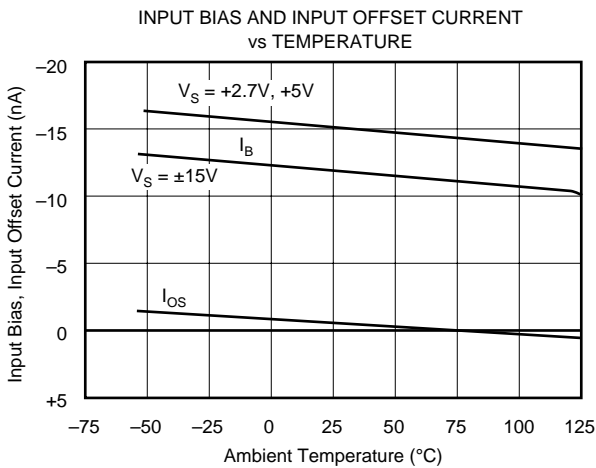
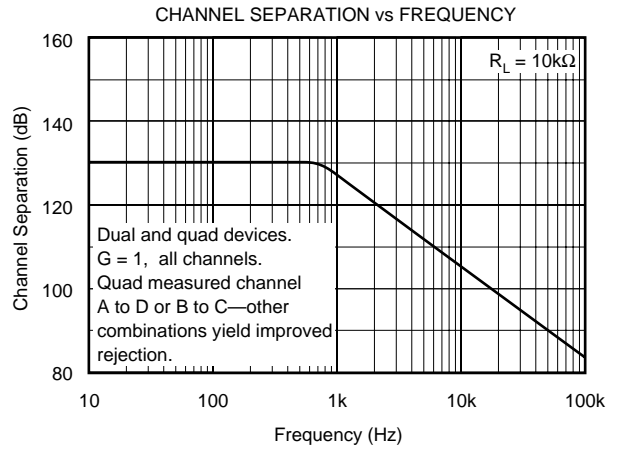
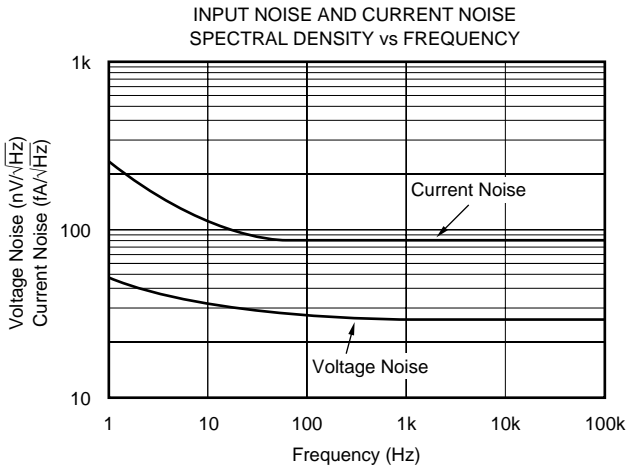
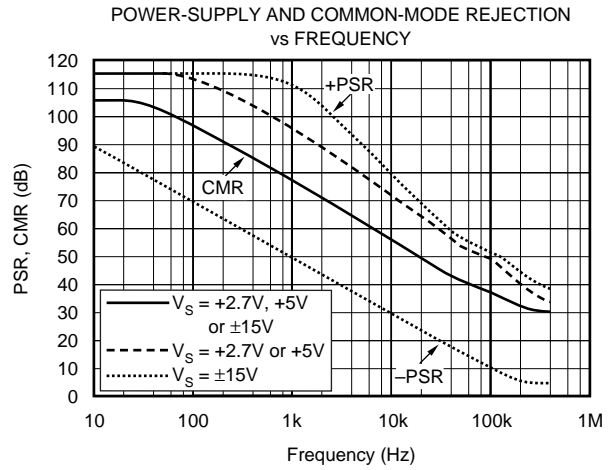
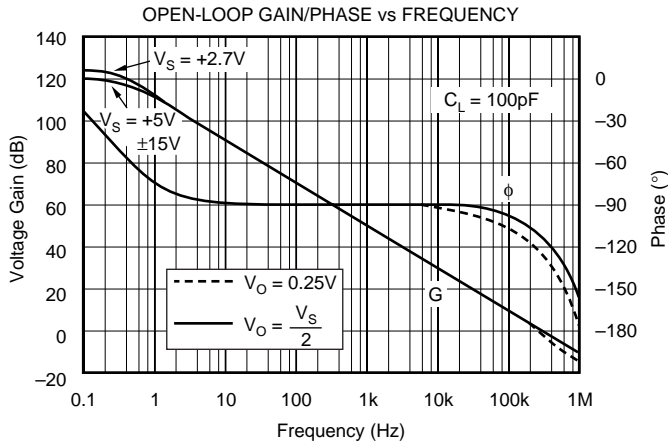

# TYPICAL CHARACTERISTIC CURVES (Cont.)

At  $T_A = +25^\circ\text{C}$  and  $R_L = 10\text{k}\Omega$ , unless otherwise noted.

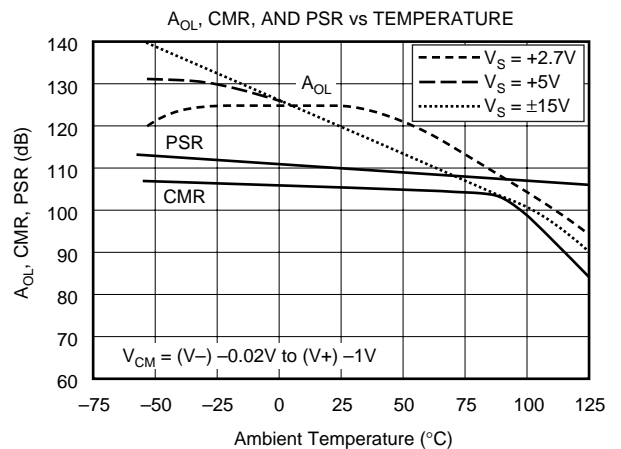
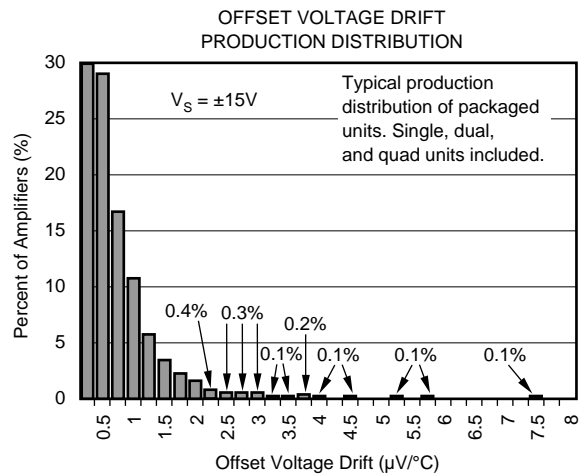
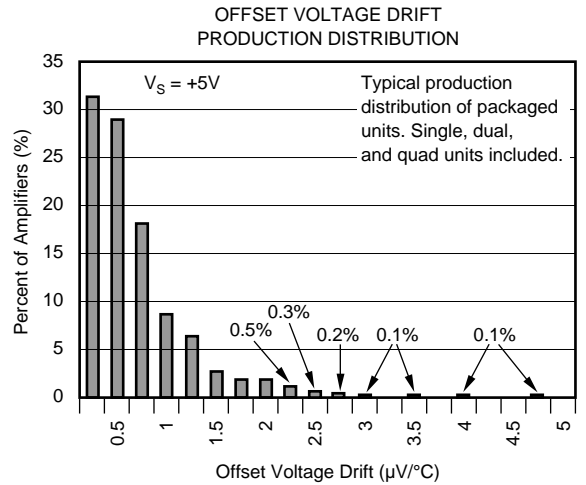
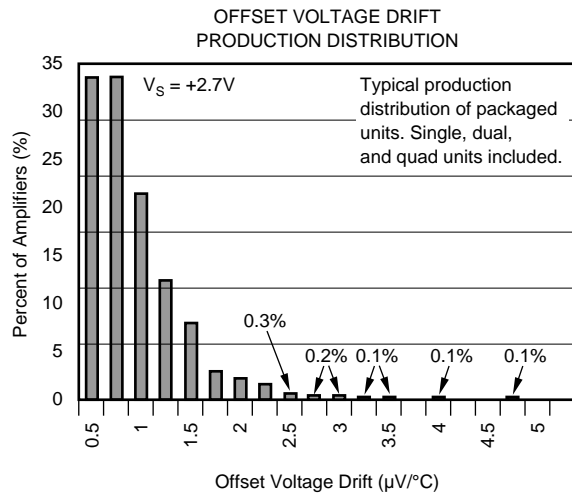
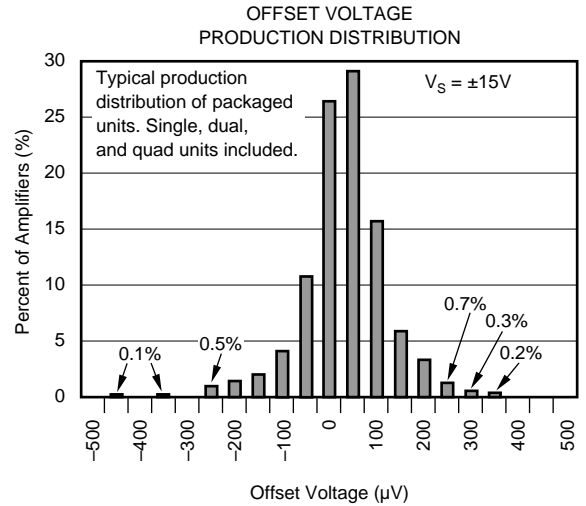
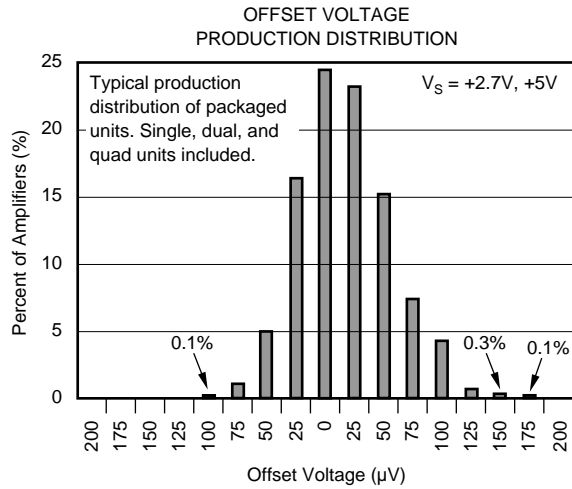

# TYPICAL CHARACTERISTIC CURVES (Cont.)

At  $T_A = +25^\circ\text{C}$  and  $R_L = 10\text{k}\Omega$ , unless otherwise noted.

SMALL-SIGNAL STEP RESPONSE  
 $G = 1$ ,  $C_L = 100\text{pF}$ ,  $V_S = +5\text{V}$

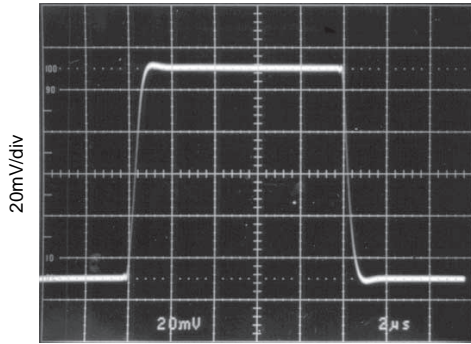

SMALL-SIGNAL STEP RESPONSE  
 $G = 1$ ,  $C_L = 10,000\text{pF}$ ,  $V_S = +5\text{V}$

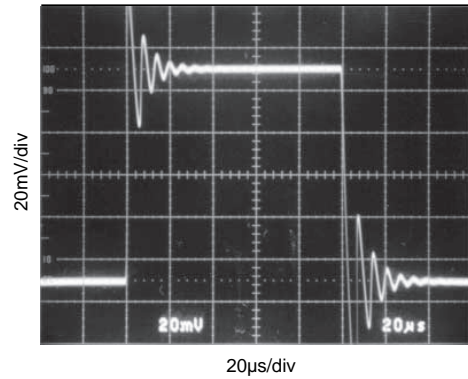

LARGE-SIGNAL STEP RESPONSE  
 $G = 1$ ,  $C_L = 100\text{pF}$ ,  $V_S = +5\text{V}$

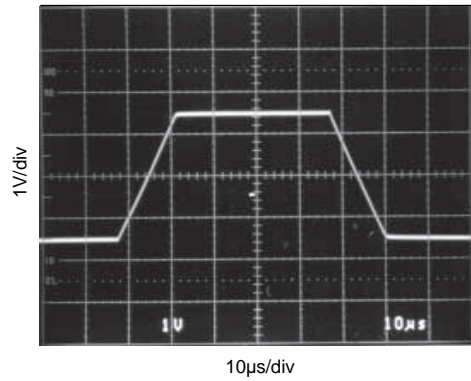

SETTLING TIME vs CLOSED-LOOP GAIN

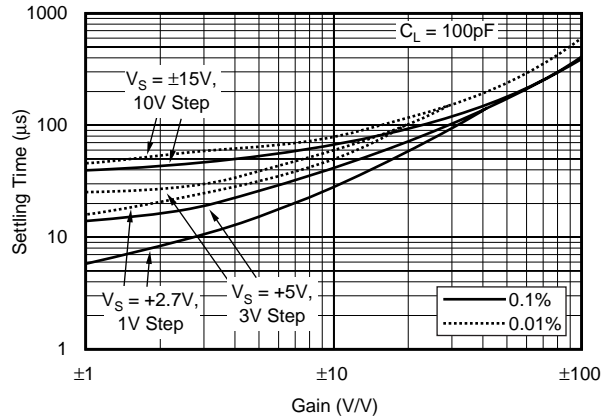

OUTPUT VOLTAGE SWING vs OUTPUT CURRENT

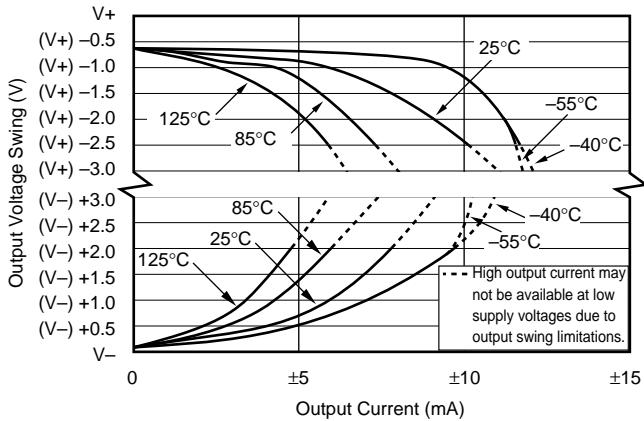

SMALL-SIGNAL OVERSHOOT vs LOAD CAPACITANCE

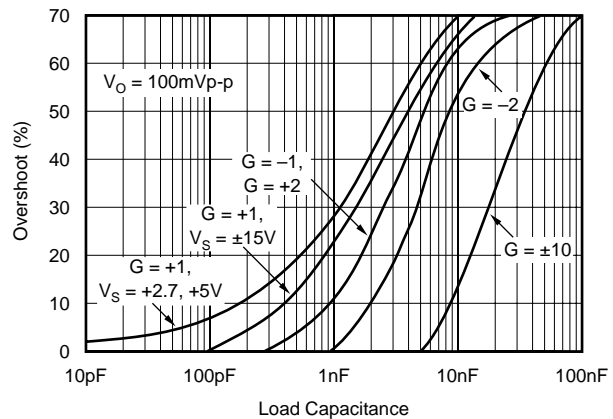



# TYPICAL CHARACTERISTIC CURVES (Cont.)

At  $T_A = +25^\circ\text{C}$  and  $R_L = 10\text{k}\Omega$ , unless otherwise noted.

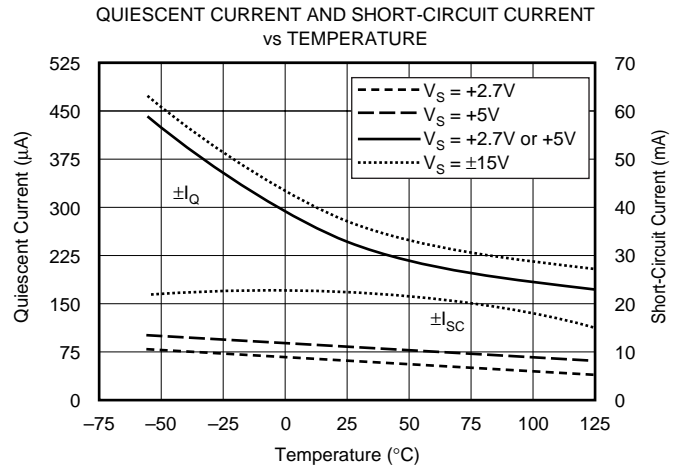
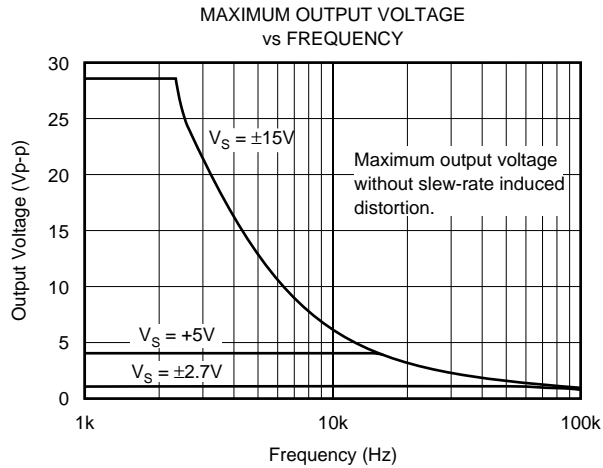

## APPLICATIONS INFORMATION

The OPA234 series op amps are unity-gain stable and suitable for a wide range of general-purpose applications. Power-supply pins should be bypassed with 10nF ceramic capacitors.

### OPERATING VOLTAGE

The OPA234 series op amps operate from single (+2.7V to +36V) or dual ( $\pm 1.35\text{V}$  to  $\pm 18\text{V}$ ) supplies with excellent performance. Specifications are production tested with +2.7V, +5V, and  $\pm 15\text{V}$  supplies. Most behavior remains unchanged throughout the full operating voltage range. Parameters which vary significantly with operating voltage are shown in the Typical Characteristic curves.

### OFFSET VOLTAGE TRIM

Offset voltage of the OPA234 series amplifiers is laser trimmed and usually requires no user adjustment. The OPA234 (single op amp version) provides offset voltage trim connections on pins 1 and 5. Offset voltage can be adjusted by connecting a potentiometer, as shown in Figure 1. This adjustment should be used only to null the offset of the op amp, not to adjust system offset or offset produced by the signal source. Nulling offset could degrade the offset drift behavior of the op amp. While it is not possible to predict the exact change in drift, the effect is usually small.

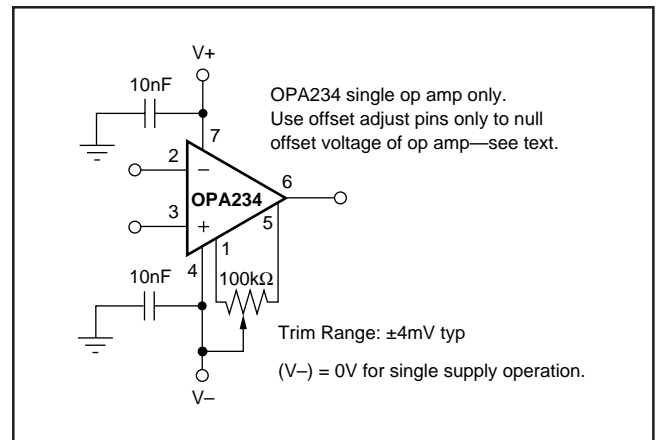

FIGURE 1. OPA234 Offset Voltage Trim Circuit.

**PACKAGING INFORMATION**

| Orderable Device | Status<br>(1) | Package Type | Package<br>Drawing | Pins | Package<br>Qty | Eco Plan<br>(2)            | Lead/Ball Finish<br>(6) | MSL Peak Temp<br>(3) | Op Temp (°C) | Device Marking<br>(4/5) | Samples                 |
|------------------|---------------|--------------|--------------------|------|----------------|----------------------------|-------------------------|----------------------|--------------|-------------------------|-------------------------|
| OPA2234P         | OBSOLETE      | PDIP         | P                  | 8    |                | TBD                        | Call TI                 | Call TI              |              |                         |                         |
| OPA2234PA        | OBSOLETE      | PDIP         | P                  | 8    |                | TBD                        | Call TI                 | Call TI              |              |                         |                         |
| OPA2234U         | ACTIVE        | SOIC         | D                  | 8    | 75             | Green (RoHS<br>& no Sb/Br) | CU NIPDAU-DCC           | Level-3-260C-168 HR  | -40 to 85    | OPA<br>2234U            | <a href="#">Samples</a> |
| OPA2234U-2/2K5   | OBSOLETE      | SOIC         | D                  | 8    |                | TBD                        | Call TI                 | Call TI              |              |                         |                         |
| OPA2234U/2K5     | ACTIVE        | SOIC         | D                  | 8    | 2500           | Green (RoHS<br>& no Sb/Br) | CU NIPDAU-DCC           | Level-3-260C-168 HR  | -40 to 85    | OPA<br>2234U            | <a href="#">Samples</a> |
| OPA2234U/2K5E4   | PREVIEW       | SOIC         | D                  | 8    |                | TBD                        | Call TI                 | Call TI              | -40 to 85    |                         |                         |
| OPA2234U/2K5G4   | ACTIVE        | SOIC         | D                  | 8    | 2500           | Green (RoHS<br>& no Sb/Br) | CU NIPDAU-DCC           | Level-3-260C-168 HR  | -40 to 85    | OPA<br>2234U            | <a href="#">Samples</a> |
| OPA2234UA        | ACTIVE        | SOIC         | D                  | 8    | 75             | Green (RoHS<br>& no Sb/Br) | CU NIPDAU-DCC           | Level-3-260C-168 HR  | -40 to 85    | OPA<br>2234U<br>A       | <a href="#">Samples</a> |
| OPA2234UA/2K5    | ACTIVE        | SOIC         | D                  | 8    | 2500           | Green (RoHS<br>& no Sb/Br) | CU NIPDAU-DCC           | Level-3-260C-168 HR  | -40 to 85    | OPA<br>2234U<br>A       | <a href="#">Samples</a> |
| OPA2234UA/2K5E4  | PREVIEW       | SOIC         | D                  | 8    |                | TBD                        | Call TI                 | Call TI              | -40 to 85    |                         |                         |
| OPA2234UA/2K5G4  | ACTIVE        | SOIC         | D                  | 8    | 2500           | Green (RoHS<br>& no Sb/Br) | CU NIPDAU-DCC           | Level-3-260C-168 HR  | -40 to 85    | OPA<br>2234U<br>A       | <a href="#">Samples</a> |
| OPA2234UAE4      | PREVIEW       | SOIC         | D                  | 8    |                | TBD                        | Call TI                 | Call TI              | -40 to 85    |                         |                         |
| OPA2234UAG4      | ACTIVE        | SOIC         | D                  | 8    | 75             | Green (RoHS<br>& no Sb/Br) | CU NIPDAU-DCC           | Level-3-260C-168 HR  | -40 to 85    | OPA<br>2234U<br>A       | <a href="#">Samples</a> |
| OPA2234UE4       | PREVIEW       | SOIC         | D                  | 8    |                | TBD                        | Call TI                 | Call TI              | -40 to 85    |                         |                         |
| OPA2234UG4       | ACTIVE        | SOIC         | D                  | 8    | 75             | Green (RoHS<br>& no Sb/Br) | CU NIPDAU-DCC           | Level-3-260C-168 HR  | -40 to 85    | OPA<br>2234U            | <a href="#">Samples</a> |
| OPA234E/250      | ACTIVE        | VSSOP        | DGK                | 8    | 250            | Green (RoHS<br>& no Sb/Br) | CU NIPDAU   Call TI     | Level-3-260C-168 HR  | -40 to 125   | A34                     | <a href="#">Samples</a> |
| OPA234E/250G4    | ACTIVE        | VSSOP        | DGK                | 8    | 250            | Green (RoHS<br>& no Sb/Br) | CU NIPDAU               | Level-3-260C-168 HR  | -40 to 125   | A34                     | <a href="#">Samples</a> |
| OPA234E/2K5      | ACTIVE        | VSSOP        | DGK                | 8    | 2500           | Green (RoHS<br>& no Sb/Br) | CU NIPDAU   Call TI     | Level-3-260C-168 HR  | -40 to 125   | A34                     | <a href="#">Samples</a> |
| OPA234E/2K5E4    | PREVIEW       | VSSOP        | DGK                | 8    |                | TBD                        | Call TI                 | Call TI              | -40 to 125   |                         |                         |

| Orderable Device | Status<br>(1) | Package Type | Package Drawing | Pins | Package Qty | Eco Plan<br>(2)         | Lead/Ball Finish<br>(6) | MSL Peak Temp<br>(3) | Op Temp (°C) | Device Marking<br>(4/5) | Samples                 |
|------------------|---------------|--------------|-----------------|------|-------------|-------------------------|-------------------------|----------------------|--------------|-------------------------|-------------------------|
| OPA234EA/250     | ACTIVE        | VSSOP        | DGK             | 8    | 250         | Green (RoHS & no Sb/Br) | CU NIPDAU   Call TI     | Level-3-260C-168 HR  | -40 to 125   | A34                     | <a href="#">Samples</a> |
| OPA234EA/250G4   | ACTIVE        | VSSOP        | DGK             | 8    | 250         | Green (RoHS & no Sb/Br) | CU NIPDAU               | Level-3-260C-168 HR  | -40 to 125   | A34                     | <a href="#">Samples</a> |
| OPA234EA/2K5     | ACTIVE        | VSSOP        | DGK             | 8    | 2500        | Green (RoHS & no Sb/Br) | CU NIPDAU   Call TI     | Level-3-260C-168 HR  | -40 to 125   | A34                     | <a href="#">Samples</a> |
| OPA234P          | OBSOLETE      | PDIP         | P               | 8    |             | TBD                     | Call TI                 | Call TI              |              |                         |                         |
| OPA234PA         | OBSOLETE      | PDIP         | P               | 8    |             | TBD                     | Call TI                 | Call TI              |              |                         |                         |
| OPA234U          | ACTIVE        | SOIC         | D               | 8    | 75          | Green (RoHS & no Sb/Br) | CU NIPDAU-DCC           | Level-3-260C-168 HR  | -40 to 125   | OPA 234U                | <a href="#">Samples</a> |
| OPA234U/2K5      | ACTIVE        | SOIC         | D               | 8    | 2500        | Green (RoHS & no Sb/Br) | CU NIPDAU-DCC           | Level-3-260C-168 HR  | -40 to 125   | OPA 234U                | <a href="#">Samples</a> |
| OPA234UA         | ACTIVE        | SOIC         | D               | 8    | 75          | Green (RoHS & no Sb/Br) | CU NIPDAU-DCC           | Level-3-260C-168 HR  | -40 to 125   | OPA 234U A              | <a href="#">Samples</a> |
| OPA234UA/2K5     | ACTIVE        | SOIC         | D               | 8    | 2500        | Green (RoHS & no Sb/Br) | CU NIPDAU-DCC           | Level-3-260C-168 HR  | -40 to 125   | OPA 234U A              | <a href="#">Samples</a> |
| OPA234UA/2K5E4   | PREVIEW       | SOIC         | D               | 8    |             | TBD                     | Call TI                 | Call TI              | -40 to 125   |                         |                         |
| OPA234UA/2K5G4   | ACTIVE        | SOIC         | D               | 8    | 2500        | Green (RoHS & no Sb/Br) | CU NIPDAU-DCC           | Level-3-260C-168 HR  | -40 to 125   | OPA 234U A              | <a href="#">Samples</a> |
| OPA234UAE4       | PREVIEW       | SOIC         | D               | 8    |             | TBD                     | Call TI                 | Call TI              | -40 to 125   |                         |                         |
| OPA234UAG4       | OBSOLETE      | SOIC         | D               | 8    |             | TBD                     | Call TI                 | Call TI              | -40 to 125   |                         |                         |
| OPA234UG4        | ACTIVE        | SOIC         | D               | 8    | 75          | Green (RoHS & no Sb/Br) | CU NIPDAU-DCC           | Level-3-260C-168 HR  | -40 to 125   | OPA 234U                | <a href="#">Samples</a> |
| OPA4234PA        | OBSOLETE      | PDIP         | N               | 14   |             | TBD                     | Call TI                 | Call TI              |              |                         |                         |
| OPA4234U         | ACTIVE        | SOIC         | D               | 14   | 50          | Green (RoHS & no Sb/Br) | CU NIPDAU-DCC           | Level-3-260C-168 HR  | -40 to 85    | OPA4234U                | <a href="#">Samples</a> |
| OPA4234U/2K5     | ACTIVE        | SOIC         | D               | 14   | 2500        | Green (RoHS & no Sb/Br) | CU NIPDAU-DCC           | Level-3-260C-168 HR  | -40 to 85    | OPA4234U                | <a href="#">Samples</a> |
| OPA4234U/2K5E4   | PREVIEW       | SOIC         | D               | 14   |             | TBD                     | Call TI                 | Call TI              | -40 to 85    |                         |                         |
| OPA4234UA        | ACTIVE        | SOIC         | D               | 14   | 50          | Green (RoHS & no Sb/Br) | CU NIPDAU-DCC           | Level-3-260C-168 HR  | -40 to 85    | OPA4234U A              | <a href="#">Samples</a> |
| OPA4234UA/2K5    | ACTIVE        | SOIC         | D               | 14   | 2500        | Green (RoHS & no Sb/Br) | CU NIPDAU-DCC           | Level-3-260C-168 HR  | -40 to 85    | OPA4234U A              | <a href="#">Samples</a> |

| Orderable Device | Status<br>(1) | Package Type | Package Drawing | Pins | Package Qty | Eco Plan<br>(2)         | Lead/Ball Finish<br>(6) | MSL Peak Temp<br>(3) | Op Temp (°C) | Device Marking<br>(4/5) | Samples |
|------------------|---------------|--------------|-----------------|------|-------------|-------------------------|-------------------------|----------------------|--------------|-------------------------|---------|
| OPA4234UA/2K5E4  | PREVIEW       | SOIC         | D               | 14   |             | TBD                     | Call TI                 | Call TI              | -40 to 85    |                         |         |
| OPA4234UA/2K5G4  | ACTIVE        | SOIC         | D               | 14   | 2500        | Green (RoHS & no Sb/Br) | CU NIPDAU-DCC           | Level-3-260C-168 HR  | -40 to 85    | OPA4234U<br>A           | Samples |
| OPA4234UAE4      | PREVIEW       | SOIC         | D               | 14   |             | TBD                     | Call TI                 | Call TI              | -40 to 85    |                         |         |
| OPA4234UAG4      | ACTIVE        | SOIC         | D               | 14   | 50          | Green (RoHS & no Sb/Br) | CU NIPDAU-DCC           | Level-3-260C-168 HR  | -40 to 85    | OPA4234U<br>A           | Samples |
| OPA4234UE4       | PREVIEW       | SOIC         | D               | 14   |             | TBD                     | Call TI                 | Call TI              | -40 to 85    |                         |         |
| OPA4234UG4       | ACTIVE        | SOIC         | D               | 14   | 50          | Green (RoHS & no Sb/Br) | CU NIPDAU-DCC           | Level-3-260C-168 HR  | -40 to 85    | OPA4234U                | Samples |

(1) The marketing status values are defined as follows:

**ACTIVE:** Product device recommended for new designs.

**LIFEBUY:** TI has announced that the device will be discontinued, and a lifetime-buy period is in effect.

**NRND:** Not recommended for new designs. Device is in production to support existing customers, but TI does not recommend using this part in a new design.

**PREVIEW:** Device has been announced but is not in production. Samples may or may not be available.

**OBSOLETE:** TI has discontinued the production of the device.

(2) Eco Plan - The planned eco-friendly classification: Pb-Free (RoHS), Pb-Free (RoHS Exempt), or Green (RoHS & no Sb/Br) - please check <http://www.ti.com/productcontent> for the latest availability information and additional product content details.

**TBD:** The Pb-Free/Green conversion plan has not been defined.

**Pb-Free (RoHS):** TI's terms "Lead-Free" or "Pb-Free" mean semiconductor products that are compatible with the current RoHS requirements for all 6 substances, including the requirement that lead not exceed 0.1% by weight in homogeneous materials. Where designed to be soldered at high temperatures, TI Pb-Free products are suitable for use in specified lead-free processes.

**Pb-Free (RoHS Exempt):** This component has a RoHS exemption for either 1) lead-based flip-chip solder bumps used between the die and package, or 2) lead-based die adhesive used between the die and leadframe. The component is otherwise considered Pb-Free (RoHS compatible) as defined above.

**Green (RoHS & no Sb/Br):** TI defines "Green" to mean Pb-Free (RoHS compatible), and free of Bromine (Br) and Antimony (Sb) based flame retardants (Br or Sb do not exceed 0.1% by weight in homogeneous material)

(3) MSL, Peak Temp. - The Moisture Sensitivity Level rating according to the JEDEC industry standard classifications, and peak solder temperature.

(4) There may be additional marking, which relates to the logo, the lot trace code information, or the environmental category on the device.

(5) Multiple Device Markings will be inside parentheses. Only one Device Marking contained in parentheses and separated by a "-" will appear on a device. If a line is indented then it is a continuation of the previous line and the two combined represent the entire Device Marking for that device.

(6) Lead/Ball Finish - Orderable Devices may have multiple material finish options. Finish options are separated by a vertical ruled line. Lead/Ball Finish values may wrap to two lines if the finish value exceeds the maximum column width.

**Important Information and Disclaimer:** The information provided on this page represents TI's knowledge and belief as of the date that it is provided. TI bases its knowledge and belief on information provided by third parties, and makes no representation or warranty as to the accuracy of such information. Efforts are underway to better integrate information from third parties. TI has taken and continues to take reasonable steps to provide representative and accurate information but may not have conducted destructive testing or chemical analysis on incoming materials and chemicals. TI and TI suppliers consider certain information to be proprietary, and thus CAS numbers and other limited information may not be available for release.

In no event shall TI's liability arising out of such information exceed the total purchase price of the TI part(s) at issue in this document sold by TI to Customer on an annual basis.

**OTHER QUALIFIED VERSIONS OF OPA2234 :**

- Military: [OPA2234M](#)

NOTE: Qualified Version Definitions:

- Military - QML certified for Military and Defense Applications

**TAPE AND REEL INFORMATION**

**QUADRANT ASSIGNMENTS FOR PIN 1 ORIENTATION IN TAPE**

\*All dimensions are nominal

| Device        | Package Type | Package Drawing | Pins | SPQ  | Reel Diameter (mm) | Reel Width W1 (mm) | A0 (mm) | B0 (mm) | K0 (mm) | P1 (mm) | W (mm) | Pin1 Quadrant |
|---------------|--------------|-----------------|------|------|--------------------|--------------------|---------|---------|---------|---------|--------|---------------|
| OPA2234U/2K5  | SOIC         | D               | 8    | 2500 | 330.0              | 12.4               | 6.4     | 5.2     | 2.1     | 8.0     | 12.0   | Q1            |
| OPA2234UA/2K5 | SOIC         | D               | 8    | 2500 | 330.0              | 12.4               | 6.4     | 5.2     | 2.1     | 8.0     | 12.0   | Q1            |
| OPA234E/250   | VSSOP        | DGK             | 8    | 250  | 180.0              | 12.4               | 5.3     | 3.4     | 1.4     | 8.0     | 12.0   | Q1            |
| OPA234E/2K5   | VSSOP        | DGK             | 8    | 2500 | 330.0              | 12.4               | 5.3     | 3.4     | 1.4     | 8.0     | 12.0   | Q1            |
| OPA234EA/250  | VSSOP        | DGK             | 8    | 250  | 180.0              | 12.4               | 5.3     | 3.4     | 1.4     | 8.0     | 12.0   | Q1            |
| OPA234EA/2K5  | VSSOP        | DGK             | 8    | 2500 | 330.0              | 12.4               | 5.3     | 3.4     | 1.4     | 8.0     | 12.0   | Q1            |
| OPA234U/2K5   | SOIC         | D               | 8    | 2500 | 330.0              | 12.4               | 6.4     | 5.2     | 2.1     | 8.0     | 12.0   | Q1            |
| OPA234UA/2K5  | SOIC         | D               | 8    | 2500 | 330.0              | 12.4               | 6.4     | 5.2     | 2.1     | 8.0     | 12.0   | Q1            |
| OPA4234U/2K5  | SOIC         | D               | 14   | 2500 | 330.0              | 16.4               | 6.5     | 9.0     | 2.1     | 8.0     | 16.0   | Q1            |
| OPA4234UA/2K5 | SOIC         | D               | 14   | 2500 | 330.0              | 16.4               | 6.5     | 9.0     | 2.1     | 8.0     | 16.0   | Q1            |

**TAPE AND REEL BOX DIMENSIONS**

\*All dimensions are nominal

| Device        | Package Type | Package Drawing | Pins | SPQ  | Length (mm) | Width (mm) | Height (mm) |
|---------------|--------------|-----------------|------|------|-------------|------------|-------------|
| OPA2234U/2K5  | SOIC         | D               | 8    | 2500 | 367.0       | 367.0      | 35.0        |
| OPA2234UA/2K5 | SOIC         | D               | 8    | 2500 | 367.0       | 367.0      | 35.0        |
| OPA234E/250   | VSSOP        | DGK             | 8    | 250  | 210.0       | 185.0      | 35.0        |
| OPA234E/2K5   | VSSOP        | DGK             | 8    | 2500 | 367.0       | 367.0      | 35.0        |
| OPA234EA/250  | VSSOP        | DGK             | 8    | 250  | 210.0       | 185.0      | 35.0        |
| OPA234EA/2K5  | VSSOP        | DGK             | 8    | 2500 | 367.0       | 367.0      | 35.0        |
| OPA234U/2K5   | SOIC         | D               | 8    | 2500 | 367.0       | 367.0      | 35.0        |
| OPA234UA/2K5  | SOIC         | D               | 8    | 2500 | 367.0       | 367.0      | 35.0        |
| OPA4234U/2K5  | SOIC         | D               | 14   | 2500 | 367.0       | 367.0      | 38.0        |
| OPA4234UA/2K5 | SOIC         | D               | 14   | 2500 | 367.0       | 367.0      | 38.0        |

P (R-PDIP-T8)

PLASTIC DUAL-IN-LINE PACKAGE



- NOTES:
- A. All linear dimensions are in inches (millimeters).
  - B. This drawing is subject to change without notice.
  - C. Falls within JEDEC MS-001 variation BA.



DGK (S-PDSO-G8)

PLASTIC SMALL-OUTLINE PACKAGE



4073329/E 05/06

- NOTES:
- A. All linear dimensions are in millimeters.
  - B. This drawing is subject to change without notice.
  - C. Body length does not include mold flash, protrusions, or gate burrs. Mold flash, protrusions, or gate burrs shall not exceed 0.15 per end.
  - D. Body width does not include interlead flash. Interlead flash shall not exceed 0.50 per side.
  - E. Falls within JEDEC MO-187 variation AA, except interlead flash.

D (R-PDSO-G14)

PLASTIC SMALL OUTLINE



- NOTES:
- A. All linear dimensions are in inches (millimeters).
  - B. This drawing is subject to change without notice.
  - $\triangle C$  Body length does not include mold flash, protrusions, or gate burrs. Mold flash, protrusions, or gate burrs shall not exceed 0.006 (0,15) each side.
  - $\triangle D$  Body width does not include interlead flash. Interlead flash shall not exceed 0.017 (0,43) each side.
  - E. Reference JEDEC MS-012 variation AB.

D (R-PDSO-G14)

PLASTIC SMALL OUTLINE



4211283-3/E 08/12

- NOTES:
- All linear dimensions are in millimeters.
  - This drawing is subject to change without notice.
  - Publication IPC-7351 is recommended for alternate designs.
  - Laser cutting apertures with trapezoidal walls and also rounding corners will offer better paste release. Customers should contact their board assembly site for stencil design recommendations. Refer to IPC-7525 for other stencil recommendations.
  - Customers should contact their board fabrication site for solder mask tolerances between and around signal pads.

D (R-PDSO-G8)

PLASTIC SMALL OUTLINE

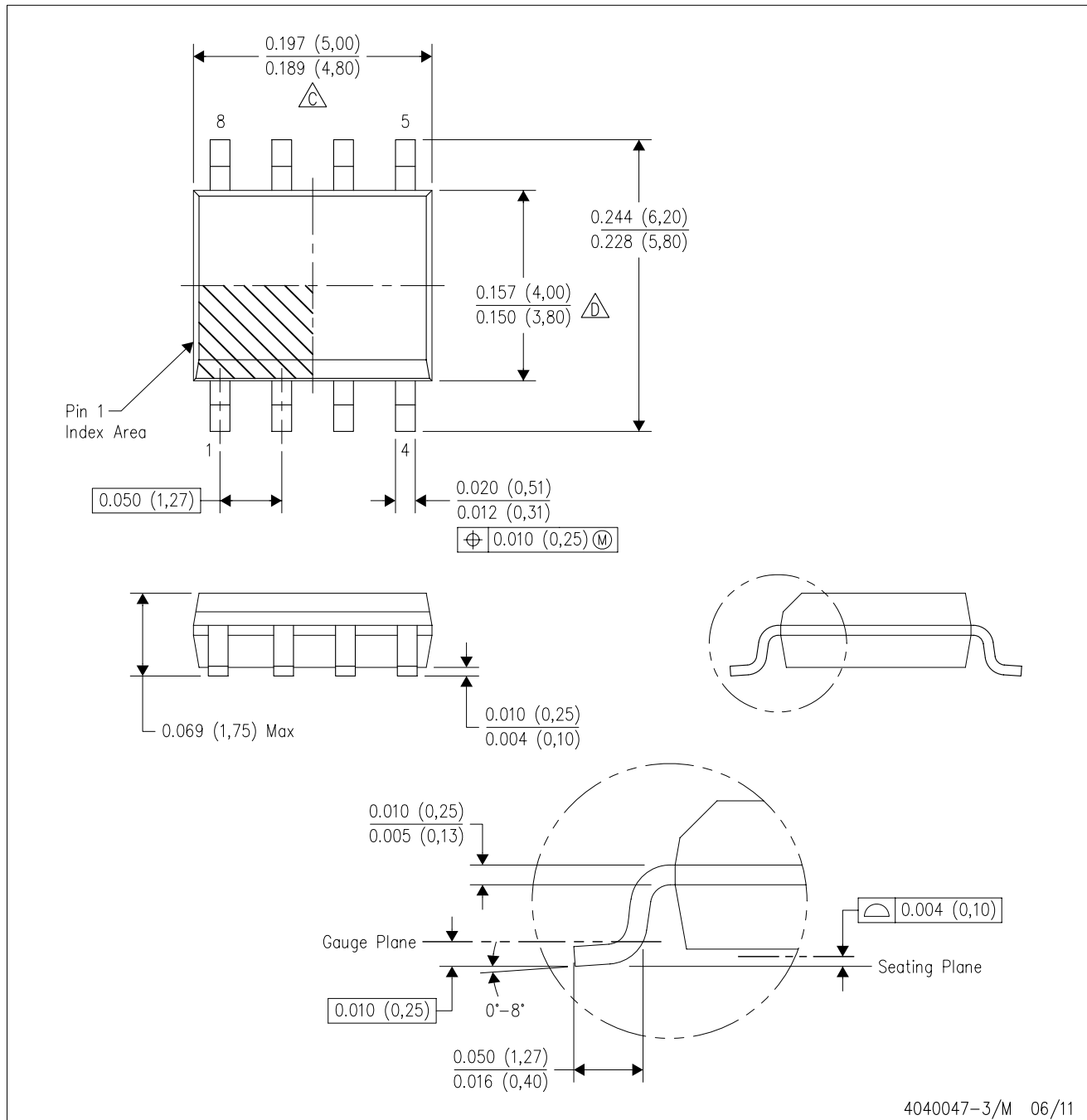

- NOTES:
- A. All linear dimensions are in inches (millimeters).
  - B. This drawing is subject to change without notice.
  - Body length does not include mold flash, protrusions, or gate burrs. Mold flash, protrusions, or gate burrs shall not exceed 0.006 (0,15) each side.
  - Body width does not include interlead flash. Interlead flash shall not exceed 0.017 (0,43) each side.
  - E. Reference JEDEC MS-012 variation AA.

D (R-PDSO-G8)

PLASTIC SMALL OUTLINE



4211283-2/E 08/12

- NOTES:
- A. All linear dimensions are in millimeters.
  - B. This drawing is subject to change without notice.
  - C. Publication IPC-7351 is recommended for alternate designs.
  - D. Laser cutting apertures with trapezoidal walls and also rounding corners will offer better paste release. Customers should contact their board assembly site for stencil design recommendations. Refer to IPC-7525 for other stencil recommendations.
  - E. Customers should contact their board fabrication site for solder mask tolerances between and around signal pads.

## IMPORTANT NOTICE

Texas Instruments Incorporated and its subsidiaries (TI) reserve the right to make corrections, enhancements, improvements and other changes to its semiconductor products and services per JESD46, latest issue, and to discontinue any product or service per JESD48, latest issue. Buyers should obtain the latest relevant information before placing orders and should verify that such information is current and complete. All semiconductor products (also referred to herein as "components") are sold subject to TI's terms and conditions of sale supplied at the time of order acknowledgment.

TI warrants performance of its components to the specifications applicable at the time of sale, in accordance with the warranty in TI's terms and conditions of sale of semiconductor products. Testing and other quality control techniques are used to the extent TI deems necessary to support this warranty. Except where mandated by applicable law, testing of all parameters of each component is not necessarily performed.

TI assumes no liability for applications assistance or the design of Buyers' products. Buyers are responsible for their products and applications using TI components. To minimize the risks associated with Buyers' products and applications, Buyers should provide adequate design and operating safeguards.

TI does not warrant or represent that any license, either express or implied, is granted under any patent right, copyright, mask work right, or other intellectual property right relating to any combination, machine, or process in which TI components or services are used. Information published by TI regarding third-party products or services does not constitute a license to use such products or services or a warranty or endorsement thereof. Use of such information may require a license from a third party under the patents or other intellectual property of the third party, or a license from TI under the patents or other intellectual property of TI.

Reproduction of significant portions of TI information in TI data books or data sheets is permissible only if reproduction is without alteration and is accompanied by all associated warranties, conditions, limitations, and notices. TI is not responsible or liable for such altered documentation. Information of third parties may be subject to additional restrictions.

Resale of TI components or services with statements different from or beyond the parameters stated by TI for that component or service voids all express and any implied warranties for the associated TI component or service and is an unfair and deceptive business practice. TI is not responsible or liable for any such statements.

Buyer acknowledges and agrees that it is solely responsible for compliance with all legal, regulatory and safety-related requirements concerning its products, and any use of TI components in its applications, notwithstanding any applications-related information or support that may be provided by TI. Buyer represents and agrees that it has all the necessary expertise to create and implement safeguards which anticipate dangerous consequences of failures, monitor failures and their consequences, lessen the likelihood of failures that might cause harm and take appropriate remedial actions. Buyer will fully indemnify TI and its representatives against any damages arising out of the use of any TI components in safety-critical applications.

In some cases, TI components may be promoted specifically to facilitate safety-related applications. With such components, TI's goal is to help enable customers to design and create their own end-product solutions that meet applicable functional safety standards and requirements. Nonetheless, such components are subject to these terms.

No TI components are authorized for use in FDA Class III (or similar life-critical medical equipment) unless authorized officers of the parties have executed a special agreement specifically governing such use.

Only those TI components which TI has specifically designated as military grade or "enhanced plastic" are designed and intended for use in military/aerospace applications or environments. Buyer acknowledges and agrees that any military or aerospace use of TI components which have **not** been so designated is solely at the Buyer's risk, and that Buyer is solely responsible for compliance with all legal and regulatory requirements in connection with such use.

TI has specifically designated certain components as meeting ISO/TS16949 requirements, mainly for automotive use. In any case of use of non-designated products, TI will not be responsible for any failure to meet ISO/TS16949.

### Products

|                              |  |
|------------------------------|--|
| Audio                        | <a href="http://www.ti.com/audio">www.ti.com/audio</a>                               |
| Amplifiers                   | <a href="http://amplifier.ti.com">amplifier.ti.com</a>                               |
| Data Converters              | <a href="http://dataconverter.ti.com">dataconverter.ti.com</a>                       |
| DLP® Products                | <a href="http://www.dlp.com">www.dlp.com</a>   |
| DSP                          | <a href="http://dsp.ti.com">dsp.ti.com</a>   |
| Clocks and Timers            | <a href="http://www.ti.com/clocks">www.ti.com/clocks</a>                             |
| Interface                    | <a href="http://interface.ti.com">interface.ti.com</a>                               |
| Logic                        | <a href="http://logic.ti.com">logic.ti.com</a>                                       |
| Power Mgmt                   | <a href="http://power.ti.com">power.ti.com</a>                                       |
| Microcontrollers             | <a href="http://microcontroller.ti.com">microcontroller.ti.com</a>                   |
| RFID                         | <a href="http://www.ti-rfid.com">www.ti-rfid.com</a>                                 |
| OMAP Applications Processors | <a href="http://www.ti.com/omap">www.ti.com/omap</a>                                 |
| Wireless Connectivity        | <a href="http://www.ti.com/wirelessconnectivity">www.ti.com/wirelessconnectivity</a> |

### Applications

|                               |  |
|-------------------------------|--|
| Automotive and Transportation | <a href="http://www.ti.com/automotive">www.ti.com/automotive</a>                         |
| Communications and Telecom    | <a href="http://www.ti.com/communications">www.ti.com/communications</a>                 |
| Computers and Peripherals     | <a href="http://www.ti.com/computers">www.ti.com/computers</a>                           |
| Consumer Electronics          | <a href="http://www.ti.com/consumer-apps">www.ti.com/consumer-apps</a>                   |
| Energy and Lighting           | <a href="http://www.ti.com/energy">www.ti.com/energy</a>                                 |
| Industrial                    | <a href="http://www.ti.com/industrial">www.ti.com/industrial</a>                         |
| Medical                       | <a href="http://www.ti.com/medical">www.ti.com/medical</a>                               |
| Security                      | <a href="http://www.ti.com/security">www.ti.com/security</a>                             |
| Space, Avionics and Defense   | <a href="http://www.ti.com/space-avionics-defense">www.ti.com/space-avionics-defense</a> |
| Video and Imaging             | <a href="http://www.ti.com/video">www.ti.com/video</a>                                   |

### TI E2E Community

[e2e.ti.com](http://e2e.ti.com)