

CD74AC10 TRIPLE 3-INPUT POSITIVE-NAND GATES

SCHS317 – NOVEMBER 2002

- AC Types Feature 1.5-V to 5.5-V Operation and Balanced Noise Immunity at 30% of the Supply Voltage
- Speed of Bipolar F, AS, and S, With Significantly Reduced Power Consumption
- Balanced Propagation Delays
- ± 24 -mA Output Drive Current
– Fanout to 15 F Devices
- SCR Latchup-Resistant CMOS Process and Circuit Design
- Exceeds 2-kV ESD Protection Per MIL-STD-883, Method 3015

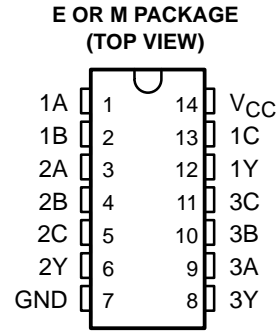

description/ordering information

The CD74AC10 contains three independent 3-input NAND gates. This device performs the Boolean function $Y = \overline{A \cdot B \cdot C}$ or $Y = \overline{A} + \overline{B} + \overline{C}$ in positive logic.

ORDERING INFORMATION

T _A	PACKAGE†		ORDERABLE PART NUMBER	TOP-SIDE MARKING
–55°C to 125°C	PDIP – E	Tube	CD74AC10E	CD74AC10E
	SOIC – M	Tube	CD74AC10M	AC10M
		Tape and Reel	CD74AC10M96	

† Package drawings, standard packing quantities, thermal data, symbolization, and PCB design guidelines are available at www.ti.com/sc/package.

FUNCTION TABLE (each gate)

INPUTS			OUTPUT
A	B	C	Y
H	H	H	L
L	X	X	H
X	L	X	H
X	X	L	H

logic diagram, each gate (positive logic)

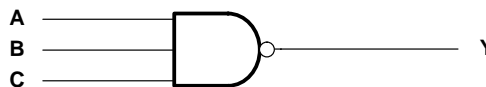

Please be aware that an important notice concerning availability, standard warranty, and use in critical applications of Texas Instruments semiconductor products and disclaimers thereto appears at the end of this data sheet.

PRODUCTION DATA information is current as of publication date. Products conform to specifications per the terms of Texas Instruments standard warranty. Production processing does not necessarily include testing of all parameters.

 **TEXAS
INSTRUMENTS**

POST OFFICE BOX 655303 • DALLAS, TEXAS 75265

Copyright © 2002, Texas Instruments Incorporated

CD74AC10

TRIPLE 3-INPUT POSITIVE-NAND GATES

SCHS317 – NOVEMBER 2002

absolute maximum ratings over operating free-air temperature range (unless otherwise noted)†

Supply voltage range, V_{CC}	-0.5 V to 6 V
Input clamp current, I_{IK} ($V_I < 0$ or $V_I > V_{CC}$) (see Note 1)	± 20 mA
Output clamp current, I_{OK} ($V_O < 0$ or $V_O > V_{CC}$) (see Note 1)	± 50 mA
Continuous output current, I_O ($V_O = 0$ to V_{CC})	± 50 mA
Continuous current through V_{CC} or GND	± 100 mA
Package thermal impedance, θ_{JA} (see Note 2): E package	80°C/W
M package	86°C/W
Storage temperature range, T_{stg}	-65°C to 150°C

† Stresses beyond those listed under “absolute maximum ratings” may cause permanent damage to the device. These are stress ratings only, and functional operation of the device at these or any other conditions beyond those indicated under “recommended operating conditions” is not implied. Exposure to absolute-maximum-rated conditions for extended periods may affect device reliability.

- NOTES: 1. The input and output voltage ratings may be exceeded if the input and output current ratings are observed.
 2. The package thermal impedance is calculated in accordance with JESD 51-7.

recommended operating conditions (see Note 3)

		$T_A = 25^\circ\text{C}$		$-55^\circ\text{C to } 125^\circ\text{C}$		$-40^\circ\text{C to } 85^\circ\text{C}$		UNIT
		MIN	MAX	MIN	MAX	MIN	MAX	
V_{CC}	Supply voltage	1.5	5.5	1.5	5.5	1.5	5.5	V
V_{IH}	High-level input voltage	$V_{CC} = 1.5\text{ V}$		1.2	1.2	1.2		V
		$V_{CC} = 3\text{ V}$		2.1	2.1	2.1		
		$V_{CC} = 5.5\text{ V}$		3.85	3.85	3.85		
V_{IL}	Low-level input voltage	$V_{CC} = 1.5\text{ V}$			0.3		0.3	V
		$V_{CC} = 3\text{ V}$			0.9		0.9	
		$V_{CC} = 5.5\text{ V}$			1.65		1.65	
V_I	Input voltage	0	V_{CC}	0	V_{CC}	0	V_{CC}	V
V_O	Output voltage	0	V_{CC}	0	V_{CC}	0	V_{CC}	V
I_{OH}	High-level output current	$V_{CC} = 4.5\text{ V to } 5.5\text{ V}$		-24	-24	-24		mA
I_{OL}	Low-level output current	$V_{CC} = 4.5\text{ V to } 5.5\text{ V}$		24	24	24		mA
$\Delta t/\Delta v$	Input transition rise or fall rate	$V_{CC} = 1.5\text{ V to } 3\text{ V}$		50	50	50		ns/V
		$V_{CC} = 3.6\text{ V to } 5.5\text{ V}$		20	20	20		

NOTE 3: All unused inputs of the device must be held at V_{CC} or GND to ensure proper device operation. Refer to the TI application report, *Implications of Slow or Floating CMOS Inputs*, literature number SCBA004.



electrical characteristics over recommended operating free-air temperature range (unless otherwise noted)

PARAMETER	TEST CONDITIONS		V _{CC}	T _A = 25°C		–55°C to 125°C		–40°C to 85°C		UNIT
				MIN	MAX	MIN	MAX	MIN	MAX	
V _{OH}	V _I = V _{IH} or V _{IL}	I _{OH} = –50 μA	1.5 V	1.4	1.4	1.4			V	
			3 V	2.9	2.9	2.9				
			4.5 V	4.4	4.4	4.4				
		I _{OH} = –4 mA	3 V	2.58	2.4	2.48				
		I _{OH} = –24 mA	4.5 V	3.94	3.7	3.8				
		I _{OH} = –50 mA†	5.5 V		3.85					
		I _{OH} = –75 mA†	5.5 V			3.85				
V _{OL}	V _I = V _{IH} or V _{IL}	I _{OL} = 50 μA	1.5 V		0.1	0.1		0.1	V	
			3 V		0.1	0.1		0.1		
			4.5 V		0.1	0.1		0.1		
		I _{OL} = 12 mA	3 V		0.36	0.5		0.44		
		I _{OL} = 24 mA	4.5 V		0.36	0.5		0.44		
		I _{OL} = 50 mA†	5.5 V			1.65				
		I _{OL} = 75 mA†	5.5 V				1.65			
I _I	V _I = V _{CC} or GND		5.5 V		±0.1	±1		±1	μA	
I _{CC}	V _I = V _{CC} or GND, I _O = 0		5.5 V		4	80		40	μA	
C _i					10	10		10	pF	

† Test one output at a time, not exceeding 1-second duration. Measurement is made by forcing indicated current and measuring voltage to minimize power dissipation. Test verifies a minimum 50-Ω transmission-line drive capability at 85°C and 75-Ω transmission-line drive capability at 125°C.

switching characteristics over recommended operating free-air temperature range, V_{CC} = 1.5 V, C_L = 50 pF (unless otherwise noted) (see Figure 1)

PARAMETER	FROM (INPUT)	TO (OUTPUT)	–55°C to 125°C		–40°C to 85°C		UNIT
			MIN	MAX	MIN	MAX	
t _{PLH}	A, B, or C	Y		153		139	ns
t _{PHL}			153		139		

switching characteristics over recommended operating free-air temperature range, V_{CC} = 3.3 V ± 0.3 V, C_L = 50 pF (unless otherwise noted) (see Figure 1)

PARAMETER	FROM (INPUT)	TO (OUTPUT)	–55°C to 125°C		–40°C to 85°C		UNIT
			MIN	MAX	MIN	MAX	
t _{PLH}	A, B, or C	Y	4.3	17.1	4.4	15.5	ns
t _{PHL}			4.3	17.1	4.4	15.5	

CD74AC10

TRIPLE 3-INPUT POSITIVE-NAND GATES

SCHS317 – NOVEMBER 2002

switching characteristics over recommended operating free-air temperature range,
 $V_{CC} = 5\text{ V} \pm 0.5\text{ V}$, $C_L = 50\text{ pF}$ (unless otherwise noted) (see Figure 1)

PARAMETER	FROM (INPUT)	TO (OUTPUT)	-55°C to 125°C		-40°C to 85°C		UNIT
			MIN	MAX	MIN	MAX	
t _{PLH}	A, B, or C	Y	3.1	12.2	3.1	11.1	ns
t _{PHL}			3.1	12.2	3.1	11.1	

operating characteristics, $V_{CC} = 5\text{ V}$, $T_A = 25^\circ\text{C}$

PARAMETER	TYP	UNIT
C _{pd} Power dissipation capacitance	50	pF



POST OFFICE BOX 655303 • DALLAS, TEXAS 75265

PARAMETER MEASUREMENT INFORMATION

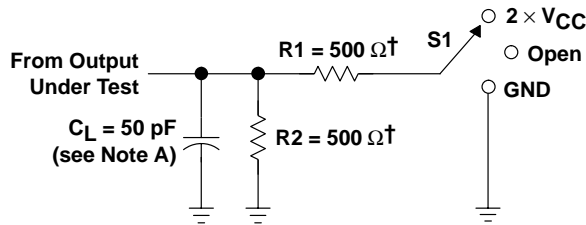

† When $V_{CC} = 1.5\text{ V}$, $R1 = R2 = 1\text{ k}\Omega$

LOAD CIRCUIT

TEST	S1
t_{PLH}/t_{PHL}	Open
t_{PLZ}/t_{PZL}	$2 \times V_{CC}$
t_{PHZ}/t_{PZH}	GND

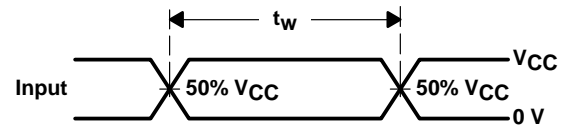

VOLTAGE WAVEFORMS
PULSE DURATION

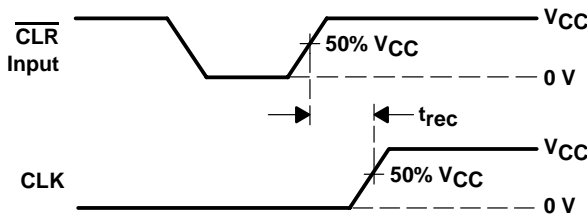

VOLTAGE WAVEFORMS
RECOVERY TIME

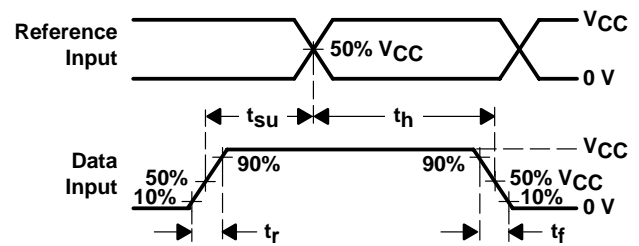

VOLTAGE WAVEFORMS
SETUP AND HOLD AND INPUT RISE AND FALL TIMES

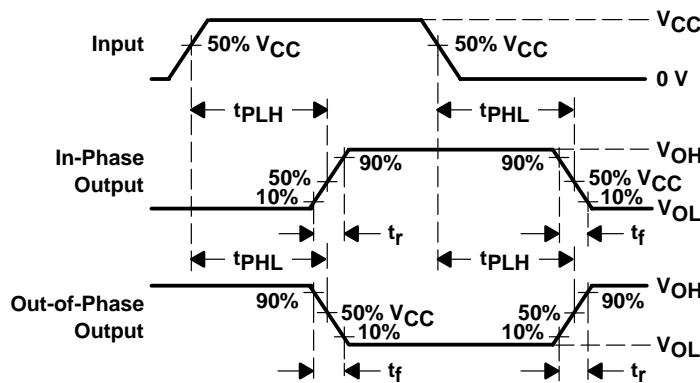

VOLTAGE WAVEFORMS
PROPAGATION DELAY AND OUTPUT TRANSITION TIMES

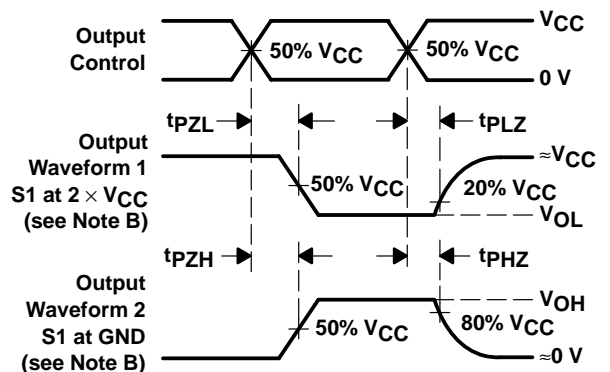

VOLTAGE WAVEFORMS
OUTPUT ENABLE AND DISABLE TIMES

- NOTES: A. C_L includes probe and test-fixture capacitance.
 B. Waveform 1 is for an output with internal conditions such that the output is low except when disabled by the output control. Waveform 2 is for an output with internal conditions such that the output is high except when disabled by the output control.
 C. All input pulses are supplied by generators having the following characteristics: $PRR \leq 1\text{ MHz}$, $Z_O = 50\ \Omega$, $t_r = 3\text{ ns}$, $t_f = 3\text{ ns}$. Phase relationships between waveforms are arbitrary.
 D. For clock inputs, f_{max} is measured with the input duty cycle at 50%.
 E. The outputs are measured one at a time with one input transition per measurement.
 F. t_{PLH} and t_{PHL} are the same as t_{pd} .
 G. t_{PZL} and t_{PZH} are the same as t_{en} .
 H. t_{PLZ} and t_{PHZ} are the same as t_{dis} .

Figure 1. Load Circuit and Voltage Waveforms

PACKAGING INFORMATION

Orderable Device	Status (1)	Package Type	Package Drawing	Pins	Package Qty	Eco Plan (2)	Lead/Ball Finish (6)	MSL Peak Temp (3)	Op Temp (°C)	Device Marking (4/5)	Samples
CD74AC10E	ACTIVE	PDIP	N	14	25	Pb-Free (RoHS)	CU NIPDAU	N / A for Pkg Type	-55 to 125	CD74AC10E	Samples
CD74AC10M	ACTIVE	SOIC	D	14	50	Green (RoHS & no Sb/Br)	CU NIPDAU	Level-1-260C-UNLIM	-55 to 125	AC10M	Samples
CD74AC10M96	ACTIVE	SOIC	D	14	2500	Green (RoHS & no Sb/Br)	CU NIPDAU	Level-1-260C-UNLIM	-55 to 125	AC10M	Samples
CD74AC10M96E4	ACTIVE	SOIC	D	14	2500	Green (RoHS & no Sb/Br)	CU NIPDAU	Level-1-260C-UNLIM	-55 to 125	AC10M	Samples
CD74AC10ME4	ACTIVE	SOIC	D	14	50	Green (RoHS & no Sb/Br)	CU NIPDAU	Level-1-260C-UNLIM	-55 to 125	AC10M	Samples

(1) The marketing status values are defined as follows:

ACTIVE: Product device recommended for new designs.

LIFEBUY: TI has announced that the device will be discontinued, and a lifetime-buy period is in effect.

NRND: Not recommended for new designs. Device is in production to support existing customers, but TI does not recommend using this part in a new design.

PREVIEW: Device has been announced but is not in production. Samples may or may not be available.

OBSOLETE: TI has discontinued the production of the device.

(2) Eco Plan - The planned eco-friendly classification: Pb-Free (RoHS), Pb-Free (RoHS Exempt), or Green (RoHS & no Sb/Br) - please check <http://www.ti.com/productcontent> for the latest availability information and additional product content details.

TBD: The Pb-Free/Green conversion plan has not been defined.

Pb-Free (RoHS): TI's terms "Lead-Free" or "Pb-Free" mean semiconductor products that are compatible with the current RoHS requirements for all 6 substances, including the requirement that lead not exceed 0.1% by weight in homogeneous materials. Where designed to be soldered at high temperatures, TI Pb-Free products are suitable for use in specified lead-free processes.

Pb-Free (RoHS Exempt): This component has a RoHS exemption for either 1) lead-based flip-chip solder bumps used between the die and package, or 2) lead-based die adhesive used between the die and leadframe. The component is otherwise considered Pb-Free (RoHS compatible) as defined above.

Green (RoHS & no Sb/Br): TI defines "Green" to mean Pb-Free (RoHS compatible), and free of Bromine (Br) and Antimony (Sb) based flame retardants (Br or Sb do not exceed 0.1% by weight in homogeneous material)

(3) MSL, Peak Temp. - The Moisture Sensitivity Level rating according to the JEDEC industry standard classifications, and peak solder temperature.

(4) There may be additional marking, which relates to the logo, the lot trace code information, or the environmental category on the device.

(5) Multiple Device Markings will be inside parentheses. Only one Device Marking contained in parentheses and separated by a "~" will appear on a device. If a line is indented then it is a continuation of the previous line and the two combined represent the entire Device Marking for that device.

⁽⁶⁾ Lead/Ball Finish - Orderable Devices may have multiple material finish options. Finish options are separated by a vertical ruled line. Lead/Ball Finish values may wrap to two lines if the finish value exceeds the maximum column width.

Important Information and Disclaimer:The information provided on this page represents TI's knowledge and belief as of the date that it is provided. TI bases its knowledge and belief on information provided by third parties, and makes no representation or warranty as to the accuracy of such information. Efforts are underway to better integrate information from third parties. TI has taken and continues to take reasonable steps to provide representative and accurate information but may not have conducted destructive testing or chemical analysis on incoming materials and chemicals. TI and TI suppliers consider certain information to be proprietary, and thus CAS numbers and other limited information may not be available for release.

In no event shall TI's liability arising out of such information exceed the total purchase price of the TI part(s) at issue in this document sold by TI to Customer on an annual basis.

TAPE AND REEL INFORMATION

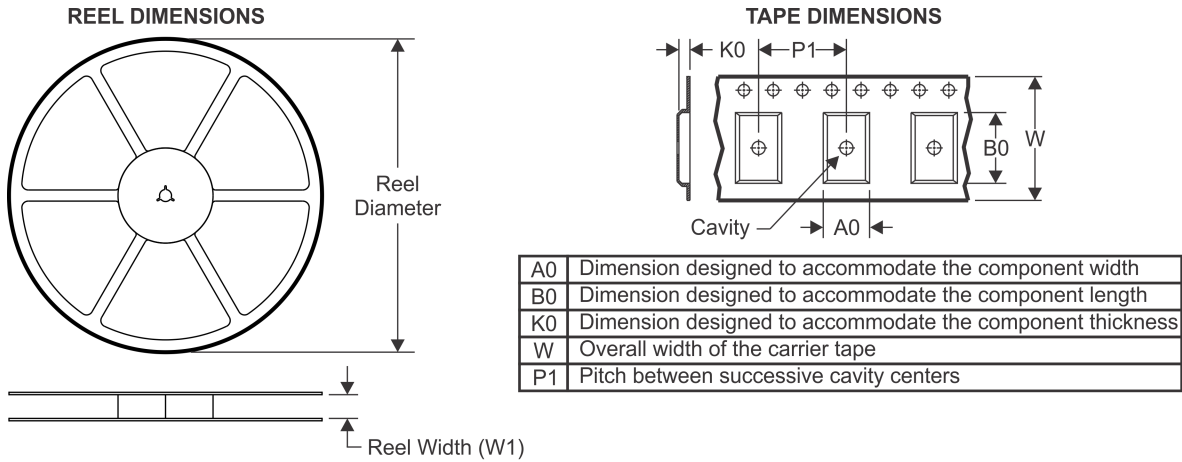

QUADRANT ASSIGNMENTS FOR PIN 1 ORIENTATION IN TAPE



*All dimensions are nominal

Device	Package Type	Package Drawing	Pins	SPQ	Reel Diameter (mm)	Reel Width W1 (mm)	A0 (mm)	B0 (mm)	K0 (mm)	P1 (mm)	W (mm)	Pin1 Quadrant
CD74AC10M96	SOIC	D	14	2500	330.0	16.4	6.5	9.0	2.1	8.0	16.0	Q1

TAPE AND REEL BOX DIMENSIONS



*All dimensions are nominal

Device	Package Type	Package Drawing	Pins	SPQ	Length (mm)	Width (mm)	Height (mm)
CD74AC10M96	SOIC	D	14	2500	367.0	367.0	38.0

N (R-PDIP-T**)

PLASTIC DUAL-IN-LINE PACKAGE

16 PINS SHOWN



- NOTES:
- A. All linear dimensions are in inches (millimeters).
 - B. This drawing is subject to change without notice.
 - (C) Falls within JEDEC MS-001, except 18 and 20 pin minimum body length (Dim A).
 - (D) The 20 pin end lead shoulder width is a vendor option, either half or full width.

D (R-PDSO-G14)

PLASTIC SMALL OUTLINE



- NOTES:
- All linear dimensions are in millimeters.
 - This drawing is subject to change without notice.
 - Publication IPC-7351 is recommended for alternate designs.
 - Laser cutting apertures with trapezoidal walls and also rounding corners will offer better paste release. Customers should contact their board assembly site for stencil design recommendations. Refer to IPC-7525 for other stencil recommendations.
 - Customers should contact their board fabrication site for solder mask tolerances between and around signal pads.

IMPORTANT NOTICE

Texas Instruments Incorporated and its subsidiaries (TI) reserve the right to make corrections, enhancements, improvements and other changes to its semiconductor products and services per JESD46, latest issue, and to discontinue any product or service per JESD48, latest issue. Buyers should obtain the latest relevant information before placing orders and should verify that such information is current and complete. All semiconductor products (also referred to herein as "components") are sold subject to TI's terms and conditions of sale supplied at the time of order acknowledgment.

TI warrants performance of its components to the specifications applicable at the time of sale, in accordance with the warranty in TI's terms and conditions of sale of semiconductor products. Testing and other quality control techniques are used to the extent TI deems necessary to support this warranty. Except where mandated by applicable law, testing of all parameters of each component is not necessarily performed.

TI assumes no liability for applications assistance or the design of Buyers' products. Buyers are responsible for their products and applications using TI components. To minimize the risks associated with Buyers' products and applications, Buyers should provide adequate design and operating safeguards.

TI does not warrant or represent that any license, either express or implied, is granted under any patent right, copyright, mask work right, or other intellectual property right relating to any combination, machine, or process in which TI components or services are used. Information published by TI regarding third-party products or services does not constitute a license to use such products or services or a warranty or endorsement thereof. Use of such information may require a license from a third party under the patents or other intellectual property of the third party, or a license from TI under the patents or other intellectual property of TI.

Reproduction of significant portions of TI information in TI data books or data sheets is permissible only if reproduction is without alteration and is accompanied by all associated warranties, conditions, limitations, and notices. TI is not responsible or liable for such altered documentation. Information of third parties may be subject to additional restrictions.

Resale of TI components or services with statements different from or beyond the parameters stated by TI for that component or service voids all express and any implied warranties for the associated TI component or service and is an unfair and deceptive business practice. TI is not responsible or liable for any such statements.

Buyer acknowledges and agrees that it is solely responsible for compliance with all legal, regulatory and safety-related requirements concerning its products, and any use of TI components in its applications, notwithstanding any applications-related information or support that may be provided by TI. Buyer represents and agrees that it has all the necessary expertise to create and implement safeguards which anticipate dangerous consequences of failures, monitor failures and their consequences, lessen the likelihood of failures that might cause harm and take appropriate remedial actions. Buyer will fully indemnify TI and its representatives against any damages arising out of the use of any TI components in safety-critical applications.

In some cases, TI components may be promoted specifically to facilitate safety-related applications. With such components, TI's goal is to help enable customers to design and create their own end-product solutions that meet applicable functional safety standards and requirements. Nonetheless, such components are subject to these terms.

No TI components are authorized for use in FDA Class III (or similar life-critical medical equipment) unless authorized officers of the parties have executed a special agreement specifically governing such use.

Only those TI components which TI has specifically designated as military grade or "enhanced plastic" are designed and intended for use in military/aerospace applications or environments. Buyer acknowledges and agrees that any military or aerospace use of TI components which have **not** been so designated is solely at the Buyer's risk, and that Buyer is solely responsible for compliance with all legal and regulatory requirements in connection with such use.

TI has specifically designated certain components as meeting ISO/TS16949 requirements, mainly for automotive use. In any case of use of non-designated products, TI will not be responsible for any failure to meet ISO/TS16949.

Products

Audio	www.ti.com/audio
Amplifiers	amplifier.ti.com
Data Converters	dataconverter.ti.com
DLP® Products	www.dlp.com
DSP	dsp.ti.com
Clocks and Timers	www.ti.com/clocks
Interface	interface.ti.com
Logic	logic.ti.com
Power Mgmt	power.ti.com
Microcontrollers	microcontroller.ti.com
RFID	www.ti-rfid.com
OMAP Applications Processors	www.ti.com/omap
Wireless Connectivity	www.ti.com/wirelessconnectivity

Applications

Automotive and Transportation	www.ti.com/automotive
Communications and Telecom	www.ti.com/communications
Computers and Peripherals	www.ti.com/computers
Consumer Electronics	www.ti.com/consumer-apps
Energy and Lighting	www.ti.com/energy
Industrial	www.ti.com/industrial
Medical	www.ti.com/medical
Security	www.ti.com/security
Space, Avionics and Defense	www.ti.com/space-avionics-defense
Video and Imaging	www.ti.com/video

TI E2E Community

e2e.ti.com