

LinCMOS™ TIMER

 Check for Samples: [TLC555-Q1](#)

FEATURES

- Qualified for Automotive Applications
- Very Low Power Consumption
 - 1 mW Typ at $V_{DD} = 5\text{ V}$
- Capable of Operation in Astable Mode
- CMOS Output Capable of Swinging Rail to Rail
- High Output-Current Capability
 - Sink 100 mA Typ
 - Source 10 mA Typ
- Output Fully Compatible With CMOS, TTL, and MOS
- Low Supply Current Reduces Spikes During Output Transitions
- Single-Supply Operation From 2 V to 15 V
- Functionally Interchangeable With the NE555; Has Same Pinout

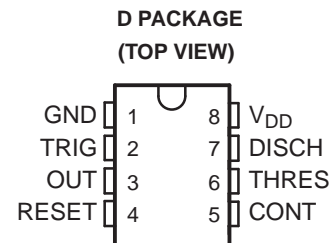

DESCRIPTION AND ORDERING INFORMATION

The TLC555 is a monolithic timing circuit fabricated using the TI LinCMOS™ process. The timer is fully compatible with CMOS, TTL, and MOS logic and operates at frequencies up to 2 MHz. Because of its high input impedance, this device uses smaller timing capacitors than those used by the NE555. As a result, more accurate time delays and oscillations are possible. Power consumption is low across the full range of power-supply voltage.

Like the NE555, the TLC555 has a trigger level equal to approximately one-third of the supply voltage and a threshold level equal to approximately two-thirds of the supply voltage. These levels can be altered by use of the control voltage terminal (CONT). When the trigger input (TRIG) falling below the trigger level sets the flip-flop, and the output goes high. Having TRIG above the trigger level and the threshold input (THRES) above the threshold level resets the flip-flop, and the output is low. The reset input (RESET) can override all other inputs, and a possible use is to initiate a new timing cycle. RESET going low resets the flip-flop, and the output is low. Whenever the output is low, a low-impedance path exists between the discharge terminal (DISCH) and GND. Tie all unused inputs to an appropriate logic level to prevent false triggering.

The advantage of the TLC555-Q1 is that it exhibits greatly reduced supply-current spikes during output transitions. Although the CMOS output is capable of sinking over 100 mA and sourcing over 10 mA, the main reason the TLC555-Q1 is able to have low current spikes is due to its edge rates. This minimizes the need for the large decoupling capacitors required by the NE555.

The TLC555 is characterized for operation over the full automotive temperature range of -40°C to 125°C .

ORDERING INFORMATION⁽¹⁾

T_A	V_{DD}	PACKAGE ⁽²⁾		ORDERABLE PART NUMBER	TOP-SIDE MARKING
-40°C to 125°C	5 V to 15 V	SOIC – D	Reel of 2500	TLC555QDRQ1	TL555Q

- (1) For the most current package and ordering information, see the Package Option Addendum at the end of this document, or see the TI Web site at www.ti.com.
- (2) Package drawings, standard packing quantities, thermal data, symbolization, and PCB design guidelines are available at www.ti.com/sc/package.



Please be aware that an important notice concerning availability, standard warranty, and use in critical applications of Texas Instruments semiconductor products and disclaimers thereto appears at the end of this data sheet.

LinCMOS is a trademark of Texas Instruments.

Table 1. FUNCTION TABLE

RESET VOLTAGE ⁽¹⁾	TRIGGER VOLTAGE ⁽¹⁾	THRESHOLD VOLTAGE ⁽¹⁾	OUTPUT	DISCHARGE SWITCH
<MIN	Irrelevant	Irrelevant	L	On
>MAX	<MIN	Irrelevant	H	Off
>MAX	>MAX	>MAX	L	On
>MAX	>MAX	<MIN	As previously established	

(1) For conditions shown as MIN or MAX, use the appropriate value specified under electrical characteristics.

FUNCTIONAL BLOCK DIAGRAM

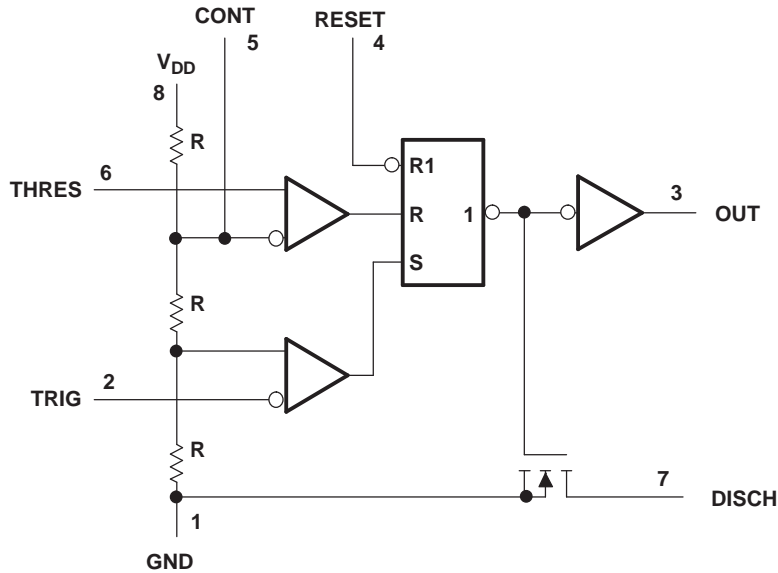

A. RESET can override TRIG, which can override THRES.

Figure 1. EQUIVALENT SCHEMATIC

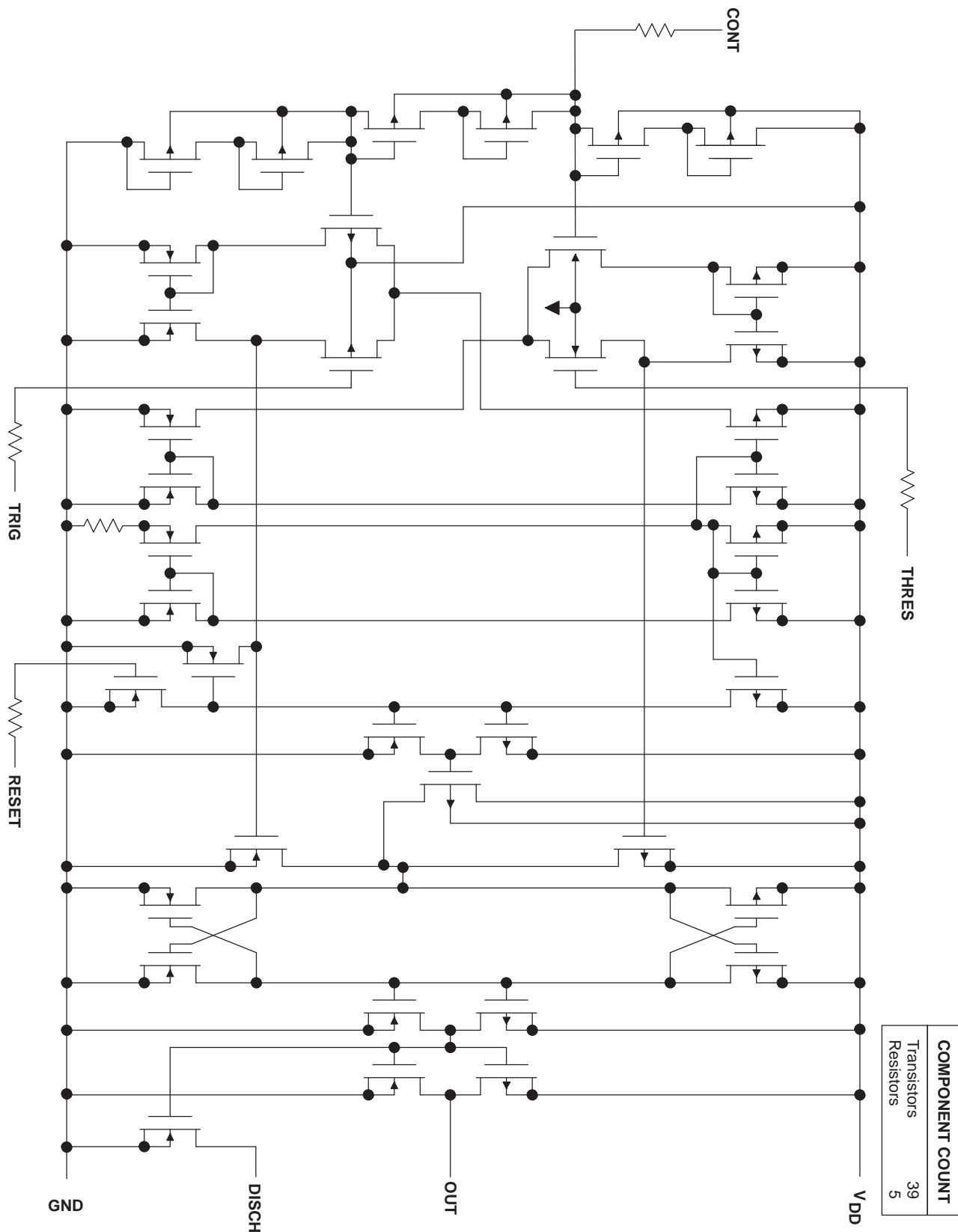

Absolute Maximum Ratings⁽¹⁾

over operating free-air temperature range (unless otherwise noted)

		MIN	MAX	UNIT
V _{DD}	Supply voltage ⁽²⁾		18	V
V _I	Input voltage range	-0.3	V _{DD}	V
	Sink current, discharge or output		150	mA
I _O	Source current, output		15	mA
	Continuous total power dissipation	See Dissipation Rating Table		
T _A	Operating free-air temperature range	-40	125	°C
T _{stg}	Storage temperature range	-65	150	°C
	HBM (human-body model) ESD		1000	V

- (1) Stresses beyond those listed under *Absolute Maximum Ratings* may cause permanent damage to the device. These are stress ratings only, and functional operation of the device at these or any other conditions beyond those indicated under *Recommended Operating Conditions* is not implied. Exposure to absolute-maximum-rated conditions for extended periods may affect device reliability.
- (2) All voltage values are with respect to network GND.

Dissipation Ratings

PACKAGE	T _A ≤ 25°C POWER RATING	DERATING FACTOR ABOVE T _A = 25°C	T _A = 125°C POWER RATING
D	725 mW	5.8 mW/°C	145 mW

Recommended Operating Conditions

		MIN	MAX	UNIT
V _{DD}	Supply voltage	2	15	V
T _A	Operating free-air temperature	-40	125	°C

Electrical Characteristics

$V_{DD} = 5\text{ V}$, at specified free-air temperature (unless otherwise noted)

PARAMETER		TEST CONDITIONS	T_A ⁽¹⁾	MIN	TYP	MAX	UNIT
V_{IT}	Threshold voltage		25°C	2.8	3.3	3.8	V
			Full range	2.7		3.9	
I_{IT}	Threshold current		25°C		10		pA
			Full range		5000		
$V_{I(TRIG)}$	Trigger voltage		25°C	1.36	1.66	1.96	V
			Full range	1.26		2.06	
$I_{I(TRIG)}$	Trigger current		25°C		10		pA
			Full range		5000		
$V_{I(RESET)}$	Reset voltage		25°C	0.4	1.1	1.5	V
			Full range	0.3		1.8	
$I_{I(RESET)}$	Reset current		25°C		10		pA
			Full range		5000		
Control voltage (open-circuit) as a percentage of supply voltage			Full range		66.7%		
	Discharge-switch on-state voltage	$I_{OL} = 10\text{ mA}$	25°C		0.14	0.5	V
			Full range			0.6	
	Discharge-switch off-state current		25°C		0.1		nA
			Full range		120		
V_{OH}	High-level output voltage	$I_{OH} = -1\text{ mA}$	25°C	4.1	4.8		V
			Full range	4.1			
V_{OL}	Low-level output voltage	$I_{OL} = 8\text{ mA}$	25°C		0.21	0.4	V
			Full range			0.6	
		$I_{OL} = 5\text{ mA}$	25°C		0.13	0.3	
			Full range			0.45	
		$I_{OL} = 3.2\text{ mA}$	25°C		0.08	0.3	
			Full range			0.4	
I_{DD}	Supply current ⁽²⁾		25°C		170	350	μA
			Full range			700	

(1) Full-range T_A is -40°C to 125°C .

(2) These values apply for the expected operating configurations in which THRES is connected directly to DISCH or TRIG.

Electrical Characteristics

$V_{DD} = 15\text{ V}$, at specified free-air temperature (unless otherwise noted)

PARAMETER		TEST CONDITIONS	T_A ⁽¹⁾	MIN	TYP	MAX	UNIT
V_{IT}	Threshold voltage		25°C	9.45	10	10.55	V
			Full range	9.35		10.65	
I_{IT}	Threshold current		25°C		10		pA
			Full range		5000		
$V_{I(TRIG)}$	Trigger voltage		25°C	4.65	5	5.35	V
			Full range	4.55		5.45	
$I_{I(TRIG)}$	Trigger current		25°C		10		pA
			Full range		5000		
$V_{I(RESET)}$	Reset voltage		25°C	0.4	1.1	1.5	V
			Full range	0.3		1.8	
$I_{I(RESET)}$	Reset current		25°C		10		pA
			Full range		5000		
	Control voltage (open-circuit) as a percentage of supply voltage		Full range		66.7%		
	Discharge-switch on-state voltage	$I_{OL} = 100\text{ mA}$	25°C		0.77	1.7	V
			Full range			1.8	
	Discharge switch off-state current		25°C		0.1		nA
			Full range		120		
V_{OH}	High-level output voltage	$I_{OH} = -10\text{ mA}$	25°C	12.5	14.2		V
			Full range	12.5			
		$I_{OH} = -5\text{ mA}$	25°C	13.5	14.6		
			Full range	13.5			
		$I_{OH} = -1\text{ mA}$	25°C	14.2	14.9		
			Full range	14.2			
V_{OL}	Low-level output voltage	$I_{OL} = 100\text{ mA}$	25°C		1.28	3.2	V
			Full range			3.8	
		$I_{OL} = 50\text{ mA}$	25°C		0.63	1	
			Full range			1.5	
		$I_{OL} = 10\text{ mA}$	25°C		0.12	0.3	
			Full range			0.45	
I_{DD}	Supply current ⁽²⁾		25°C		360	600	μA
			Full range			1000	

(1) Full-range T_A is -40°C to 125°C .

(2) These values apply for the expected operating configurations in which THRES is connected directly to DISCH or TRIG.

Operating Characteristics

 $V_{DD} = 5\text{ V}$, $T_A = 25^\circ\text{C}$ (unless otherwise noted)

PARAMETER		TEST CONDITIONS	MIN	TYP	MAX	UNIT
	Initial error of timing interval ⁽¹⁾	$V_{DD} = 5\text{ V to }15\text{ V}$, $C_T = 0.1\ \mu\text{F}$, $R_A = R_B = 1\ \text{k}\Omega\text{ to }100\ \text{k}\Omega^{(2)}$		1	3	%
	Supply voltage sensitivity of timing interval	$V_{DD} = 5\text{ V to }15\text{ V}$, $C_T = 0.1\ \mu\text{F}$, $R_A = R_B = 1\ \text{k}\Omega\text{ to }100\ \text{k}\Omega^{(2)}$		0.1	0.5	%/V
t_r	Output pulse rise time	$R_L = 10\ \text{M}\Omega$, $C_L = 10\ \text{pF}$		20	75	ns
t_f	Output pulse fall time	$R_L = 10\ \text{M}\Omega$, $C_L = 10\ \text{pF}$		15	60	ns
f_{max}	Maximum frequency in astable mode	$R_A = 470\ \Omega$, $C_T = 200\ \text{pF}$, $R_B = 200\ \Omega^{(2)}$	1.2	2.1		MHz

- (1) Timing interval error is defined as the difference between the measured value and the average value of a random sample from each process run.
- (2) R_A , R_B , and C_T are as defined in [Figure 2](#).

TYPICAL CHARACTERISTICS

DISCHARGE SWITCH ON-STATE RESISTANCE vs FREE-AIR TEMPERATURE

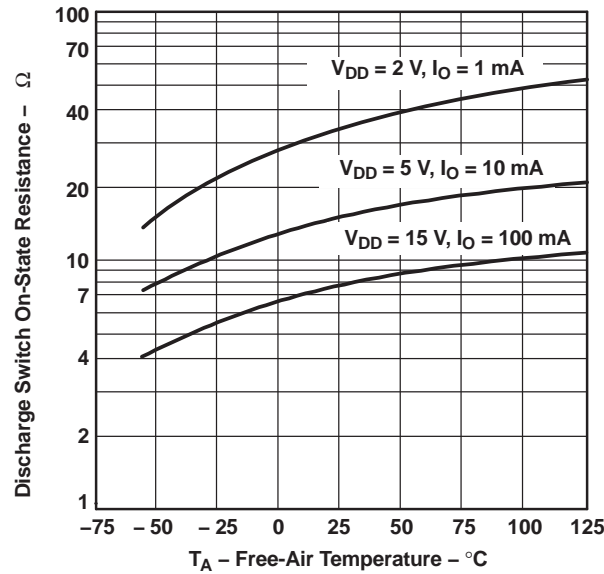
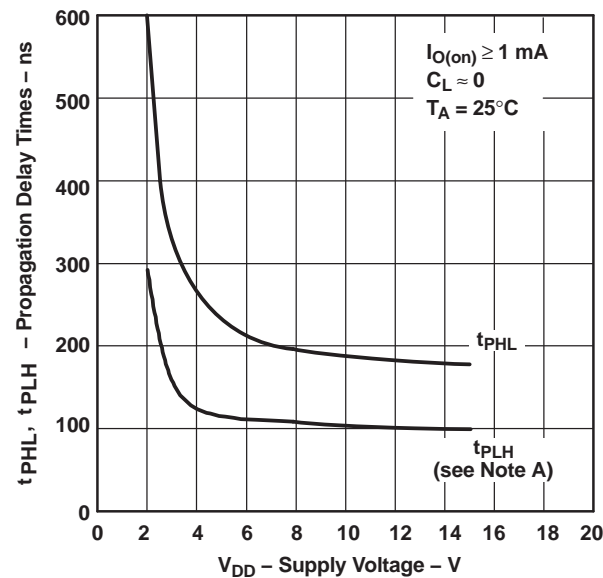

Figure 2.

PROPAGATION DELAY TIMES TO DISCHARGE OUTPUT FROM TRIGGER AND THRESHOLD SHORTED TOGETHER vs SUPPLY VOLTAGE



A. The effects of the load resistance on these values must be taken into account separately.

Figure 3.

APPLICATION INFORMATION

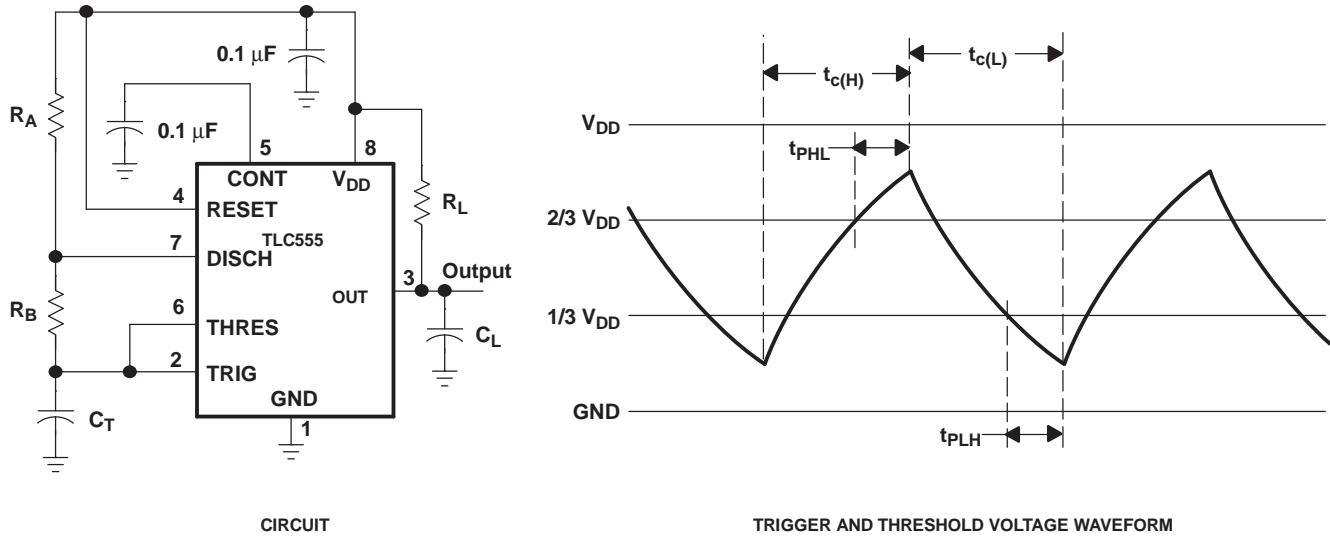

Figure 4. Astable Operation

Connecting TRIG to THRES, as shown in Figure 4, causes the timer to run as a multivibrator. The capacitor C_T charges through R_A and R_B to the threshold voltage level (approximately $0.67 V_{DD}$) and then discharges through R_B only to the value of the trigger voltage level (approximately $0.33 V_{DD}$). The output is high during the charging cycle ($t_{c(H)}$) and low during the discharge cycle ($t_{c(L)}$). The values of R_A , R_B , and C_T control the duty cycle as shown in the following equations.

$$t_{c(H)} \approx C_T (R_A + R_B) \ln 2 \quad (\ln 2 = 0.693)$$

$$t_{c(L)} \approx C_T R_B \ln 2$$

$$\text{Period} = t_{c(H)} + t_{c(L)} \approx C_T (R_A + 2R_B) \ln 2$$

$$\text{Output driver duty cycle} = \frac{t_{c(L)}}{t_{c(H)} + t_{c(L)}} \approx 1 - \frac{R_B}{R_A + 2R_B}$$

$$\text{Output waveform duty cycle} = \frac{t_{c(H)}}{t_{c(H)} + t_{c(L)}} \approx \frac{R_B}{R_A + 2R_B}$$

The 0.1- μF capacitor at CONT in Figure 4 decreases the period by about 10%.

The formulas shown above do not allow for any propagation delay times from the TRIG and THRES inputs to DISCH. These delay times add directly to the period and create differences between calculated and actual values that increase with frequency. In addition, the internal on-state resistance (r_{on}) during discharge adds to R_B to provide another source of timing error in the calculation when R_B is very low or r_{on} is very high.

The following equations provide better agreement with measured values.

$$t_{c(H)} = C_T (R_A + R_B) \ln \left[3 - \exp\left(\frac{-t_{PLH}}{C_T (R_B + r_{on})}\right) \right] + t_{PHL}$$

$$t_{c(L)} = C_T (R_B + r_{on}) \ln \left[3 - \exp\left(\frac{-t_{PHL}}{C_T (R_A + R_B)}\right) \right] + t_{PLH}$$

These equations and those given previously are similar in that a time constant is multiplied by the logarithm of a number or function. The limit values of the logarithmic terms must be between ln 2 at low frequencies and ln 3 at extremely high frequencies. For a duty cycle close to 50%, one can substitute an appropriate constant for the

logarithmic terms with good results. Duty cycles less than 50% $\frac{t_{c(H)}}{t_{c(H)} + t_{c(L)}}$ require that $\frac{t_{c(H)}}{t_{c(L)}} < 1$ and possibly $R_A \leq r_{on}$. These conditions can be difficult to obtain.

In monostable applications, a voltage applied to CONT can set the trip point on TRIG. An input voltage between 10% and 80% of the supply voltage from a resistor divider with at least 500-µA bias provides good results.

REVISION HISTORY

Changes from Revision Original (October 2006) to Revision A	Page
• Changed next-to-last paragraph in Description and Ordering Information section	1
• Changed top-side marking	1
• In the 5-V and 15-V Electrical Characteristics tables, changed all "MAX" entries in the T _A column to "Full range"	5
• Deleted the last Electrical Characteristics table, which contained only redundant data	7

PACKAGING INFORMATION

Orderable Device	Status (1)	Package Type	Package Drawing	Pins	Package Qty	Eco Plan (2)	Lead/Ball Finish	MSL Peak Temp (3)	Op Temp (°C)	Top-Side Markings (4)	Samples
TLC555QDRQ1	ACTIVE	SOIC	D	8	2500	Green (RoHS & no Sb/Br)	CU NIPDAU	Level-1-260C-UNLIM	-40 to 125	TL555Q	Samples

(1) The marketing status values are defined as follows:

ACTIVE: Product device recommended for new designs.

LIFEBUY: TI has announced that the device will be discontinued, and a lifetime-buy period is in effect.

NRND: Not recommended for new designs. Device is in production to support existing customers, but TI does not recommend using this part in a new design.

PREVIEW: Device has been announced but is not in production. Samples may or may not be available.

OBSOLETE: TI has discontinued the production of the device.

(2) Eco Plan - The planned eco-friendly classification: Pb-Free (RoHS), Pb-Free (RoHS Exempt), or Green (RoHS & no Sb/Br) - please check <http://www.ti.com/productcontent> for the latest availability information and additional product content details.

TBD: The Pb-Free/Green conversion plan has not been defined.

Pb-Free (RoHS): TI's terms "Lead-Free" or "Pb-Free" mean semiconductor products that are compatible with the current RoHS requirements for all 6 substances, including the requirement that lead not exceed 0.1% by weight in homogeneous materials. Where designed to be soldered at high temperatures, TI Pb-Free products are suitable for use in specified lead-free processes.

Pb-Free (RoHS Exempt): This component has a RoHS exemption for either 1) lead-based flip-chip solder bumps used between the die and package, or 2) lead-based die adhesive used between the die and leadframe. The component is otherwise considered Pb-Free (RoHS compatible) as defined above.

Green (RoHS & no Sb/Br): TI defines "Green" to mean Pb-Free (RoHS compatible), and free of Bromine (Br) and Antimony (Sb) based flame retardants (Br or Sb do not exceed 0.1% by weight in homogeneous material)

(3) MSL, Peak Temp. -- The Moisture Sensitivity Level rating according to the JEDEC industry standard classifications, and peak solder temperature.

(4) Multiple Top-Side Markings will be inside parentheses. Only one Top-Side Marking contained in parentheses and separated by a "~" will appear on a device. If a line is indented then it is a continuation of the previous line and the two combined represent the entire Top-Side Marking for that device.

Important Information and Disclaimer: The information provided on this page represents TI's knowledge and belief as of the date that it is provided. TI bases its knowledge and belief on information provided by third parties, and makes no representation or warranty as to the accuracy of such information. Efforts are underway to better integrate information from third parties. TI has taken and continues to take reasonable steps to provide representative and accurate information but may not have conducted destructive testing or chemical analysis on incoming materials and chemicals. TI and TI suppliers consider certain information to be proprietary, and thus CAS numbers and other limited information may not be available for release.

In no event shall TI's liability arising out of such information exceed the total purchase price of the TI part(s) at issue in this document sold by TI to Customer on an annual basis.

OTHER QUALIFIED VERSIONS OF TLC555-Q1 :

- Catalog: [TLC555](#)

- Military: [TLC555M](#)



NOTE: Qualified Version Definitions:

- Catalog - TI's standard catalog product
- Military - QML certified for Military and Defense Applications

D (R-PDSO-G8)

PLASTIC SMALL OUTLINE



- NOTES:
- A. All linear dimensions are in inches (millimeters).
 - B. This drawing is subject to change without notice.
 -  Body length does not include mold flash, protrusions, or gate burrs. Mold flash, protrusions, or gate burrs shall not exceed 0.006 (0,15) each side.
 -  Body width does not include interlead flash. Interlead flash shall not exceed 0.017 (0,43) each side.
 - E. Reference JEDEC MS-012 variation AA.

D (R-PDSO-G8)

PLASTIC SMALL OUTLINE



- NOTES:
- All linear dimensions are in millimeters.
 - This drawing is subject to change without notice.
 - Publication IPC-7351 is recommended for alternate designs.
 - Laser cutting apertures with trapezoidal walls and also rounding corners will offer better paste release. Customers should contact their board assembly site for stencil design recommendations. Refer to IPC-7525 for other stencil recommendations.
 - Customers should contact their board fabrication site for solder mask tolerances between and around signal pads.

IMPORTANT NOTICE

Texas Instruments Incorporated and its subsidiaries (TI) reserve the right to make corrections, enhancements, improvements and other changes to its semiconductor products and services per JESD46, latest issue, and to discontinue any product or service per JESD48, latest issue. Buyers should obtain the latest relevant information before placing orders and should verify that such information is current and complete. All semiconductor products (also referred to herein as "components") are sold subject to TI's terms and conditions of sale supplied at the time of order acknowledgment.

TI warrants performance of its components to the specifications applicable at the time of sale, in accordance with the warranty in TI's terms and conditions of sale of semiconductor products. Testing and other quality control techniques are used to the extent TI deems necessary to support this warranty. Except where mandated by applicable law, testing of all parameters of each component is not necessarily performed.

TI assumes no liability for applications assistance or the design of Buyers' products. Buyers are responsible for their products and applications using TI components. To minimize the risks associated with Buyers' products and applications, Buyers should provide adequate design and operating safeguards.

TI does not warrant or represent that any license, either express or implied, is granted under any patent right, copyright, mask work right, or other intellectual property right relating to any combination, machine, or process in which TI components or services are used. Information published by TI regarding third-party products or services does not constitute a license to use such products or services or a warranty or endorsement thereof. Use of such information may require a license from a third party under the patents or other intellectual property of the third party, or a license from TI under the patents or other intellectual property of TI.

Reproduction of significant portions of TI information in TI data books or data sheets is permissible only if reproduction is without alteration and is accompanied by all associated warranties, conditions, limitations, and notices. TI is not responsible or liable for such altered documentation. Information of third parties may be subject to additional restrictions.

Resale of TI components or services with statements different from or beyond the parameters stated by TI for that component or service voids all express and any implied warranties for the associated TI component or service and is an unfair and deceptive business practice. TI is not responsible or liable for any such statements.

Buyer acknowledges and agrees that it is solely responsible for compliance with all legal, regulatory and safety-related requirements concerning its products, and any use of TI components in its applications, notwithstanding any applications-related information or support that may be provided by TI. Buyer represents and agrees that it has all the necessary expertise to create and implement safeguards which anticipate dangerous consequences of failures, monitor failures and their consequences, lessen the likelihood of failures that might cause harm and take appropriate remedial actions. Buyer will fully indemnify TI and its representatives against any damages arising out of the use of any TI components in safety-critical applications.

In some cases, TI components may be promoted specifically to facilitate safety-related applications. With such components, TI's goal is to help enable customers to design and create their own end-product solutions that meet applicable functional safety standards and requirements. Nonetheless, such components are subject to these terms.

No TI components are authorized for use in FDA Class III (or similar life-critical medical equipment) unless authorized officers of the parties have executed a special agreement specifically governing such use.

Only those TI components which TI has specifically designated as military grade or "enhanced plastic" are designed and intended for use in military/aerospace applications or environments. Buyer acknowledges and agrees that any military or aerospace use of TI components which have **not** been so designated is solely at the Buyer's risk, and that Buyer is solely responsible for compliance with all legal and regulatory requirements in connection with such use.

TI has specifically designated certain components as meeting ISO/TS16949 requirements, mainly for automotive use. In any case of use of non-designated products, TI will not be responsible for any failure to meet ISO/TS16949.

Products

Audio	www.ti.com/audio
Amplifiers	amplifier.ti.com
Data Converters	dataconverter.ti.com
DLP® Products	www.dlp.com
DSP	dsp.ti.com
Clocks and Timers	www.ti.com/clocks
Interface	interface.ti.com
Logic	logic.ti.com
Power Mgmt	power.ti.com
Microcontrollers	microcontroller.ti.com
RFID	www.ti-rfid.com
OMAP Applications Processors	www.ti.com/omap
Wireless Connectivity	www.ti.com/wirelessconnectivity

Applications

Automotive and Transportation	www.ti.com/automotive
Communications and Telecom	www.ti.com/communications
Computers and Peripherals	www.ti.com/computers
Consumer Electronics	www.ti.com/consumer-apps
Energy and Lighting	www.ti.com/energy
Industrial	www.ti.com/industrial
Medical	www.ti.com/medical
Security	www.ti.com/security
Space, Avionics and Defense	www.ti.com/space-avionics-defense
Video and Imaging	www.ti.com/video

TI E2E Community

e2e.ti.com