



LPCXpresso

Getting started with NXP LPCXpresso

Rev. 12 — 17 April 2013

User guide

Document information

Info	Content
Keywords	LPCXpresso, LPC800, LPC1100, LPC1200, LPC1300, LPC1700, LPC1800, LPC2000, LPC2900, LPC3000, LPC3100, LPC3200, LPC4000, LPC4300
Abstract	LPCXpresso is a, low-cost development platform available from NXP. This document is a brief overview on how to get started with LPCXpresso.



Revision history

Rev	Date	Description
12	20130417	<ul style="list-style-type: none"> Added LPC800 Added schematics for LPC800 and LPC1104 LPCXpresso boards. Updated screenshots to match LPCXpresso version 5 Updated supported LPC products list.
11.2	20120711	<ul style="list-style-type: none"> Added system requirements for the Mac OS version. Updated supported LPC products list.
11.1	20111201	<ul style="list-style-type: none"> Updated supported LPC products list.
11	20110614	<ul style="list-style-type: none"> Updates for LPCXpresso 4- new screen shots Added 1.1 V4 new features section Updated comprehensive supported parts list Updated create new project process
10	20110407	<ul style="list-style-type: none"> Added Fig 45 and Fig 46.
9	20110301	<ul style="list-style-type: none"> Updated keywords and supported products throughout Updated Section 6.1 Updated Section 6.2.5 Updated Section 6.6.2 Removed Fig 20 Added Fig 41 and Fig 42
8	20110211	<ul style="list-style-type: none"> Updated Section 3.2 Added Fig 38, Fig 39, Fig 40, Fig 48
7	20100915	<ul style="list-style-type: none"> Updated Section 3.1
6	20100712	<ul style="list-style-type: none"> Added 7.1 Schematics for LPCXpresso LPC1768 target side Added 6.1 Installing Eclipse plugins
5	20100604	<ul style="list-style-type: none"> Added new products supported to Introduction section: LPC2929, LPC3250 Removed 6.1.6 Download performance Updated 6.4.2 Optimization section
4	20100419	<ul style="list-style-type: none"> Updated Fig 49
3	20100315	<ul style="list-style-type: none"> Updated Fig 37 Added Fig 38
2	20100311	<ul style="list-style-type: none"> Updated Section 3.1 Added Section 6.2.5
1	20100111	<ul style="list-style-type: none"> Initial version

Contact information

For additional information, please visit: <http://www.nxp.com>

For sales office addresses, please send an email to: salesaddresses@nxp.com

1. Introduction

LPCXpresso is a, low-cost development platform available from NXP. The software consists of an enhanced, Eclipse-based IDE, a GNU C compiler, linker, libraries, and an enhanced GDB debugger. The hardware consists of the LPCXpresso development board which has an LPC-Link debug interface and an NXP LPC ARM-based microcontroller target. LPCXpresso is an end-to-end solution enabling embedded engineers to develop their applications from initial evaluation to final production.

The LPCXpresso IDE, powered by Code Red Technologies (<http://lpcxpresso.code-red-tech.com>), is based on the popular Eclipse development platform and includes several LPC-specific enhancements. It is an industry-standard GNU tool-chain with an optimized C library that gives engineers all the tools necessary to develop high-quality software solutions quickly and cost-effectively. The C programming environment includes professional-level features. There is syntax coloring, source formatting, function folding, on- and offline help, and extensive project management automation.

The LPCXpresso target board, jointly developed by NXP, Code Red Technologies, and Embedded Artists (<http://www.embeddedartists.com/products/lpcxpresso/>), includes an integrated JTAG debugger (LPC-Link), so there's no need for a separate JTAG debug probe. The target portion of the board can connect to expansion boards to provide a greater variety of interfaces, and I/O devices. The on-board LPC-Link debugger provides a high-speed USB to JTAG/SWD interface to the IDE and it can be connected to other debug targets such as a customer prototype. Users can also use the LPCXpresso IDE with the Red Probe JTAG adapter from Code Red Technologies.

Supported LPC products and board part numbers on the LPCXpresso platform:

- LPC800: All part types supported
 - OM13053: LPC812
- LPC1100: All part types supported
 - OM13014: LPC11U14
 - OM13012: LPC11C24
 - OM13035: LPC1115
 - OM13047: LPC1104
- LPC1200: All part types supported
 - OM13008: LPC1227
- LPC1300: All part types supported
 - OM13045: LPC1347
- LPC1700: All part types supported
 - OM13000: LPC1769
- LPC1800: All part types supported
- LPC2000: LPC2109, LPC2109/01, LPC2134, LPC2142, LPC2362, LPC2929
- LPC3000: LPC3130, LPC3250
- LPC4000: All part types supported

LPCXpresso base board products:

- OM11083: Embedded Artists Base Board for LPCXpresso and mbed
- OM13009: Embedded Artists Motor Control Kit for LPCXpresso
- OM13016: NGX mbed-LPCXpresso baseboard

1.1 LPCXpresso 5 new features

- Support for Instruction Trace for Cortex-M3/M4 based MCUs implementing an Embedded Trace Buffer (ETB)
- Support for Instruction trace for Cortex-M0+ based systems implementing a Micro Trace Buffer (MTB)
- Based on Eclipse Juno and gcc 4.6.2
- New part support

For more information on LPCXpresso 5 new features visit:

<http://support.code-red-tech.com/CodeRedWiki/NewInVersion5>

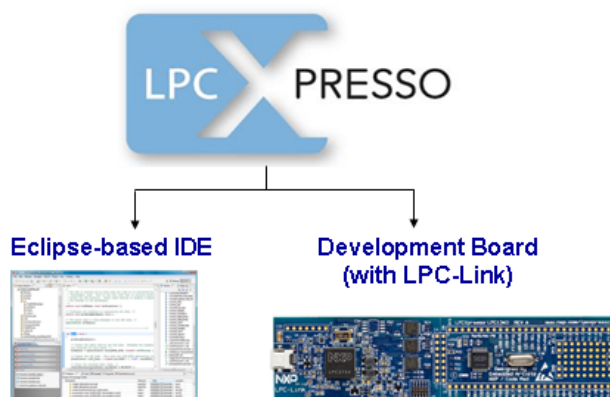

1.2 LPCXpresso IDE

LPCXpresso's IDE is a highly integrated software development environment for NXP's LPC Microcontrollers, which includes all the tools necessary to develop high quality software solutions in a timely and cost effective fashion. LPCXpresso is based on Eclipse with many LPC specific enhancements. It also features the latest version of the industry standard GNU tool chain with a proprietary optimized C library providing professional quality tools at low cost. The LPCXpresso IDE can build an executable of any size with full code optimization and it supports a download limit of 128 kB after registration. LPCXpresso supports the full embedded product design cycle by moving beyond chip evaluation boards and supporting development on external target boards.

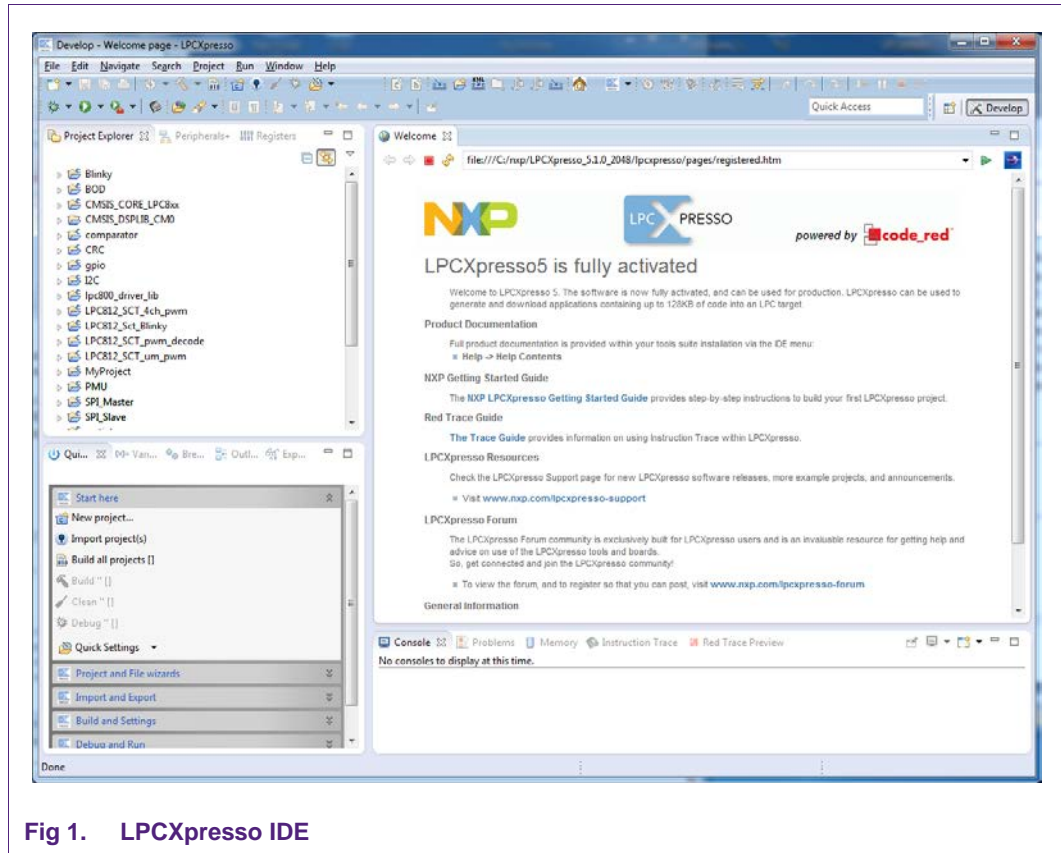

Fig 1. LPCXpresso IDE

1.3 LPCXpresso development board

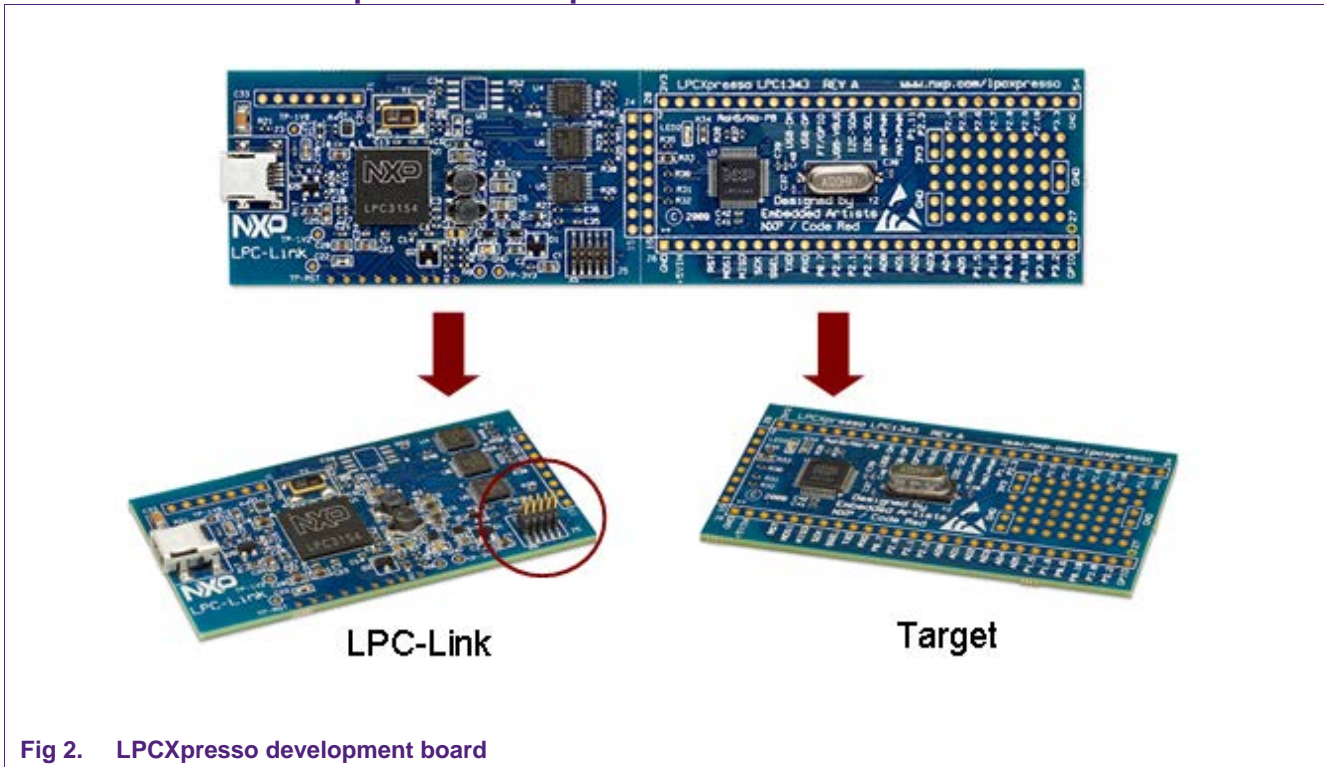

Fig 2. LPCXpresso development board

1.4 LPC-LINK JTAG/SWD debugger

The LPCXpresso board contains a JTAG/SWD debugger called the “LPC-Link” and a target MCU. LPC-Link is equipped with a 10-pin JTAG header (highlighted on the above image) and it seamlessly connects to the target via USB (the USB interface and other debug features are provided by NXP’s ARM9 based LPC3154 MCU). Cutting the tracks between the LPC-link and the target will make the LPC-Link a stand-alone JTAG debugger. This enables the LPCXpresso platform to be connected to an external target and used to develop for a wide variety of NXP’s Cortex-M0, Cortex-M3, and ARM7/9 based applications. Currently supported microcontroller products include LPC800, LPC1100, LPC1200, LPC1300, LPC1700, LPC1800, LPC4000, LPC4300 series and specific members of the LPC2000 and LPC3000 families.

1.5 Integrated evaluation target

The target includes a small prototyping area and easily accessible connections for expansion. The LPCXpresso board with target can be used

- On its own for software development and benchmarking
- Connected to an off-the-shelf baseboard for rapid proof-of-concepts
- Connected to customer-designed board for a full prototype

1.6 LPCXpresso partners

NXP has partnered with Code Red Technologies and Embedded Artists for the LPCXpresso platform. For added flexibility and higher memory configurations, the LPCXpresso platform can easily be upgraded to include full-blown suites from Code Red Technologies and more advanced hardware kits from Embedded Artists. Please visit the LPCXpresso webpage for more information.



2. Evaluate, explore and develop

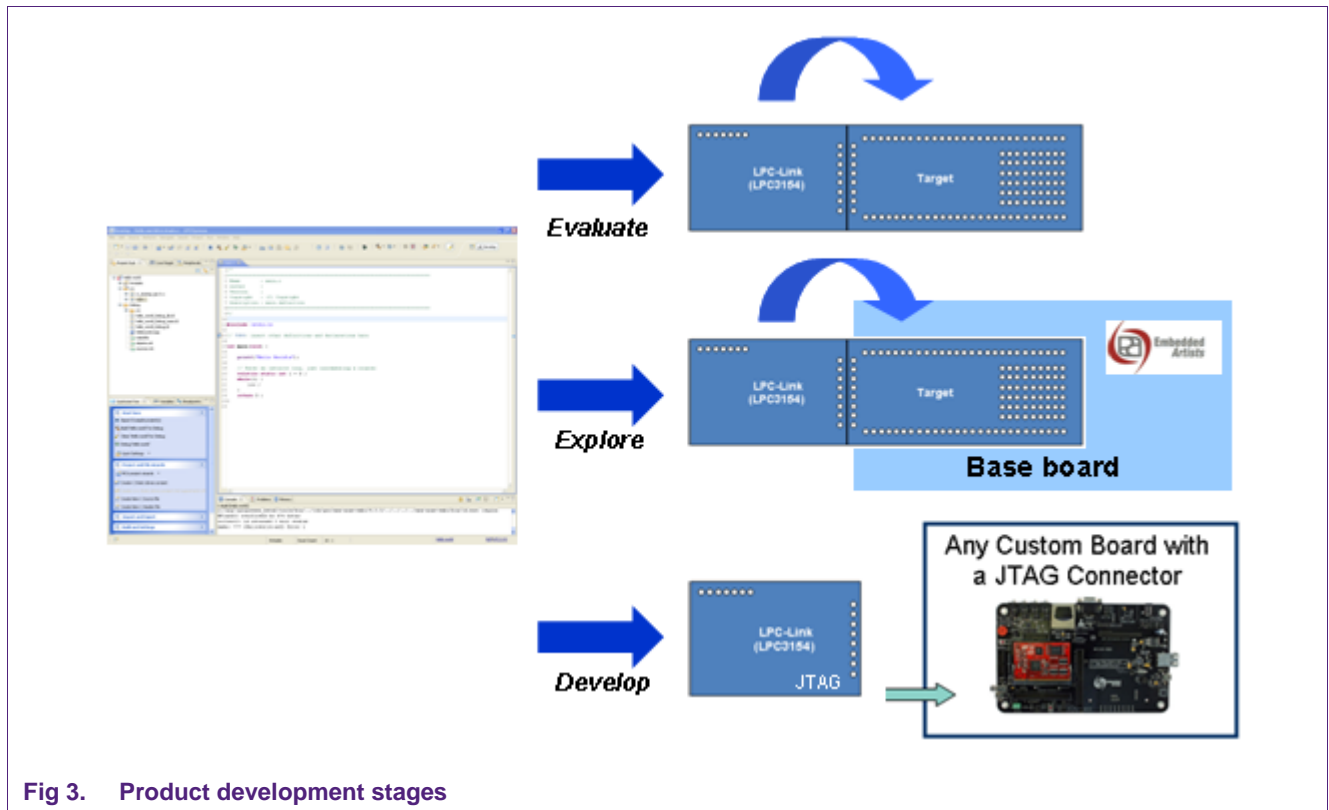

Fig 3. Product development stages

Users can envisage three stages from evaluation to product development. During evaluation, features and peripherals of the target MCU can be easily tested with the prototyping area and easily accessible connections on the target board. Complementing the target board are also easy-to-use example projects and a handy Getting Started guide. For rapid proof-of-concepts, users can get an off-the-shelf base board from Embedded Artists and quickly explore the next level of applications. And finally LPCXpresso users can seamlessly develop their final application by using the LPC-Link's 10-pin JTAG connector to attach any JTAG-capable custom board. This way, users can now enjoy the same user experience right from evaluation to product development.

3. Installation

3.1 System requirements

Operating System	Microsoft® Windows - XP 32-bit (SP2 or greater) Microsoft® Windows - Vista 32-bit or 64-bit Microsoft® Windows - Windows 7 32-bit or 64-bit Microsoft® Windows – Windows 8 Mac OS X 10.7.5 (Lion), and 10.8.2 (Mountain Lion) Linux - Ubuntu 9 trough 12Linux - Fedora 14 and 17
System RAM	2 GB MB minimum (4 GB recommended)
Hard Disk	500+ MB of available space.
Screen/Display Adaptor	1024x768 minimum recommended
Internet Connection	High-speed internet is recommended to download and register the software

Note: LPCXpresso may install and run on other Linux distributions. However, only the distributions listed above have been tested. Desktop virtualization tools supporting a Linux or Windows guest with USB support can be used to run LPCXpresso on other computing platforms.

3.2 Installation process

LPCXpresso is installed into a single directory, of your choice. Multiple versions can be installed simultaneously without any issues. The installation process is to double-click the installer file after downloading. Then click “next” on the setup wizard. To install under Linux, the downloaded file should be marked as executable first using chmod +x.

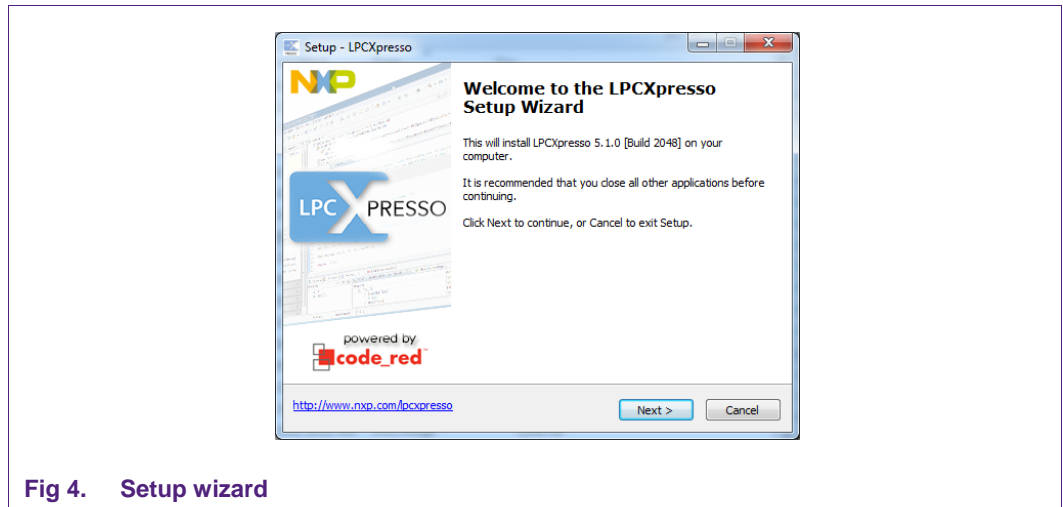

Fig 4. Setup wizard

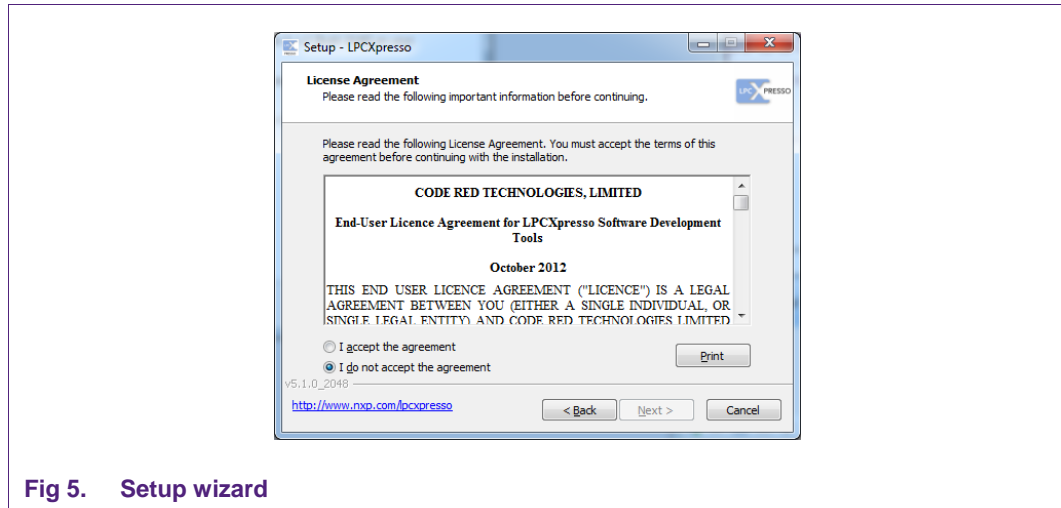

Fig 5. Setup wizard

Read the license agreement then click next. There are a number of other screens on the setup wizard, but generally the default options can be accepted. After the install, an information file will be displayed. Click "Next." Congratulations! Your LPCXpresso installation is complete!

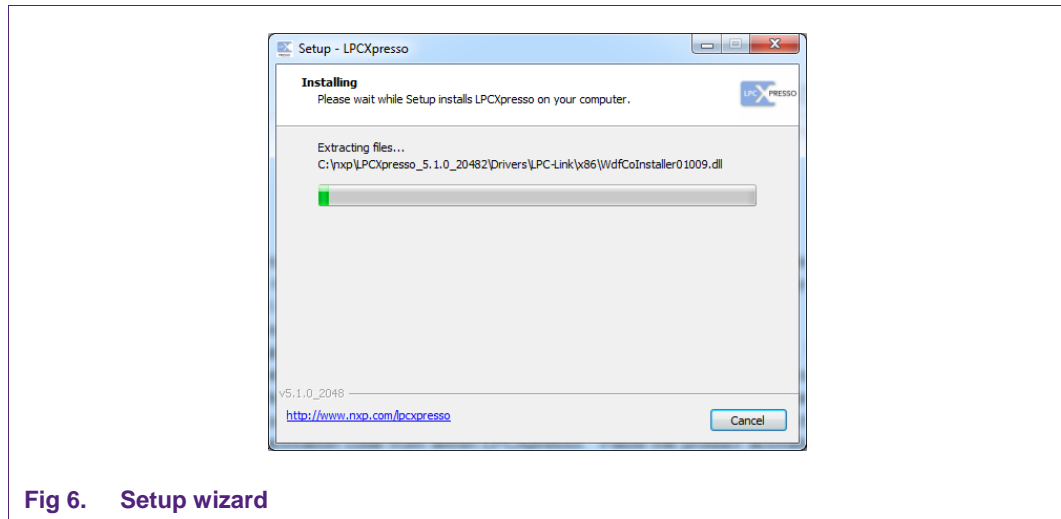

Fig 6. Setup wizard

3.3 Activation

To activate your product from LPCXpresso, choose **Help->Product activation->Create serial number and Activate**. Once the wizard is open, click “Copy to clipboard” to copy the LPCXpresso serial number into the clipboard. This serial number is based on your machine’s hardware and operating system configuration, but contains no personally identifiable information. Now click the button to open the registration activation page. This should display a web form. After completing the form, you will receive an activation code via email within a few minutes. Highlight the activation code in your email program, and select Copy to place it into the Windows clipboard. Now, choose **Help->Product activation->Enter Activation code** from within LPCXpresso. Paste the product activation code into the Product activation dialog by right clicking in the Activation code field and choosing “Paste.” Then click the “OK” button. You should receive a dialog confirming acceptance of the activation code. It is also possible to complete LPCXpresso activation on a PC that is offline as long as another PC has access to the Internet. Refer to [Fig 7](#) for the process.

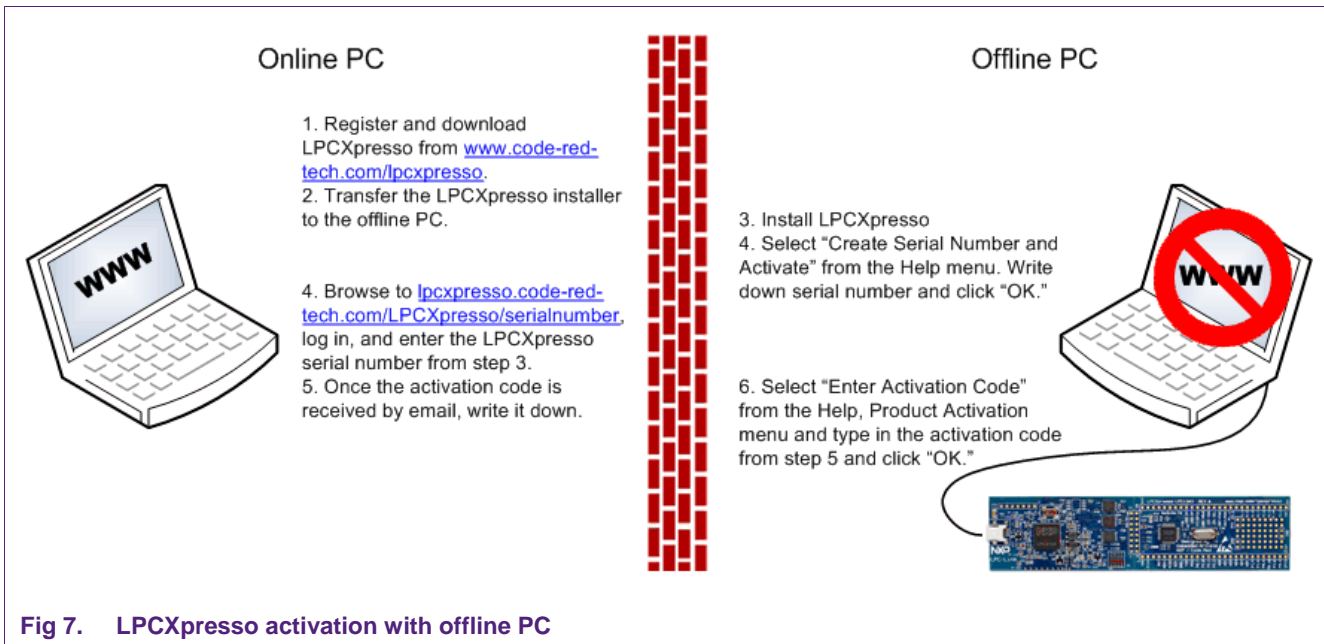

Fig 7. LPCXpresso activation with offline PC

4. Getting familiar with the LPCXpresso IDE

LPCXpresso IDE is based on the Eclipse IDE framework and many of the core features are described well in generic Eclipse documentation and in the help files found in the help menu of the product. Further documentation and pointers to useful documents are also available on the Code Red Technologies Wiki at <http://support.code-red-tech.com/CodeRedWiki>.

4.1 Layout of the LPCXpresso desktop

LPCXpresso's Desktop contains many windows. Each window is called a View, because it displays a particular view of data in the LPCXpresso environment. This data could be source code, hex dumps, disassembly, memory contents, or more. Views can be opened, moved, docked, and closed, and the layout of the currently displayed Views can be saved and restored. A specific configuration of Views is called a 'Perspective.' Typically, LPCXpresso operates in a single perspective under which both the code development & debug sessions operate as shown on the next page. The single perspective greatly simplifies the Eclipse environment and enhances the entire LPCXpresso experience.

All Views in the Perspective can be moved around by dragging and dropping. If a View is accidentally closed, it can be restored by selecting it from the Show View dialog. The Show View dialog can be opened from the Show View Other... option in the Window menu.

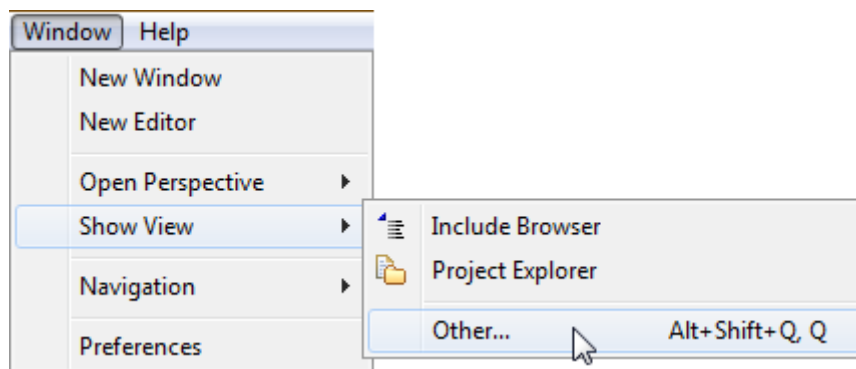

Fig 8. Show view/other menu

4.1.1 Single perspective (code development)

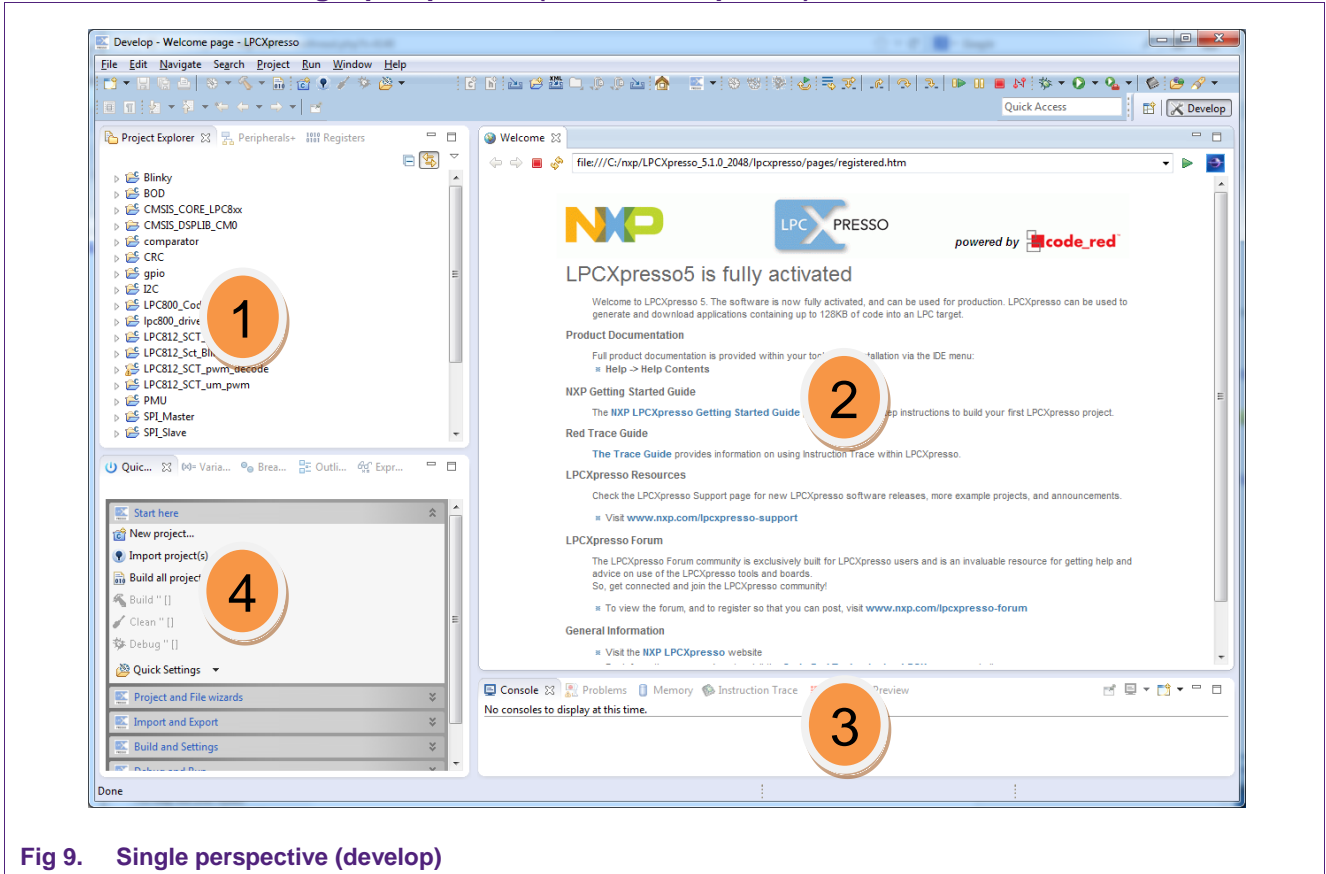

Fig 9. Single perspective (develop)

1. Project Explorer View: The 'Project Explorer' gives you a view of all the projects in your current 'Workspace'. A 'Workspace' is a collection of projects that are stored in a single Workspace Directory on your computer.
2. Editor: On the upper right is the editor which allows modification and saving of source code as well as setting breakpoints in debug mode.
3. Console and Problems Views: On the lower right are the Console and Problems Views. The Console View displays status information on compiling and debugging, as well as program output. The Problem View (available by changing tabs) shows all compiler errors and will navigate the Editor View to the error location.
4. Quick Start View: Below, the 'Quick Start' view has fast links to commonly used features. This is the best place to go to find options such as Build, Debug, and Import.

4.1.2 Single perspective (debug)

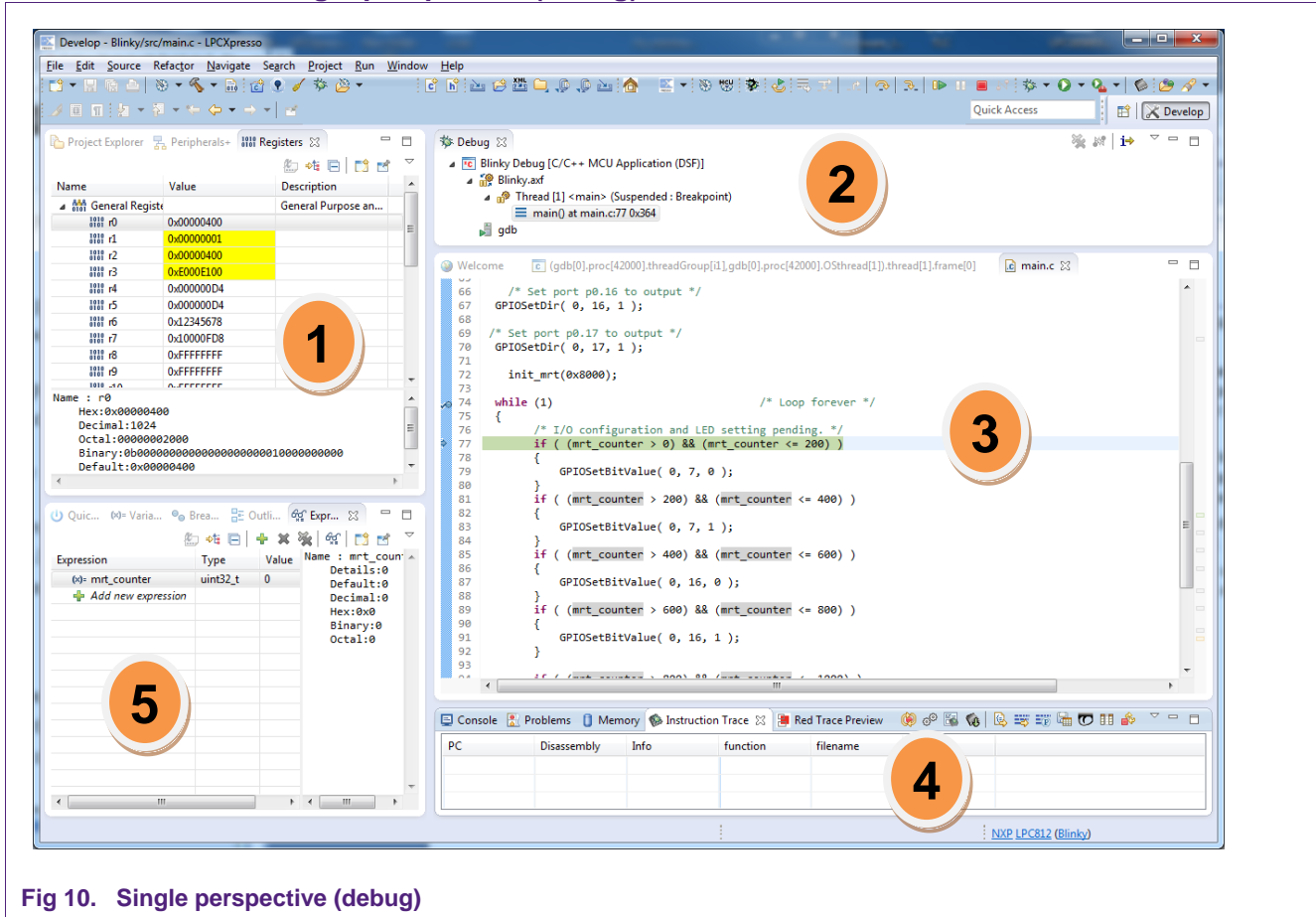

Fig 10. Single perspective (debug)

1. Core Register View: This shows all of the registers in the processor core. Registers that have changed from step to step are highlighted in yellow.
2. Debug View: This shows you the stack trace. In the 'stopped' state, you can click on any particular function and inspect its local variables in the Variables tab (parallel to the Registers View). Debug controls can be found on the global toolbar (at the top of the screen).
3. Editor: In here you will see the code you are executing and can step from line to line. By pressing the 'i' icon at the top of the Debug view, you can switch to stepping by assembly instruction. Clicking in the left margin will set and delete breakpoints.
4. Console View: On the lower right is the Console View. The Console View displays status information on compiling and debugging, as well as program output.
5. Quick Start View: Below, the 'Quick Start' view has fast links to commonly used features.

4.1.2.1 Peripheral views

LPCXpresso includes full, annotated and interactive debug views of all the peripherals. Access to the views is found on the Peripherals View (click the Peripherals tab) behind the Project Explorer view. Each peripheral can be selected, and it is displayed in the 'Memory' view which is located behind the 'Console' view at the bottom of the LPCXpresso desktop.

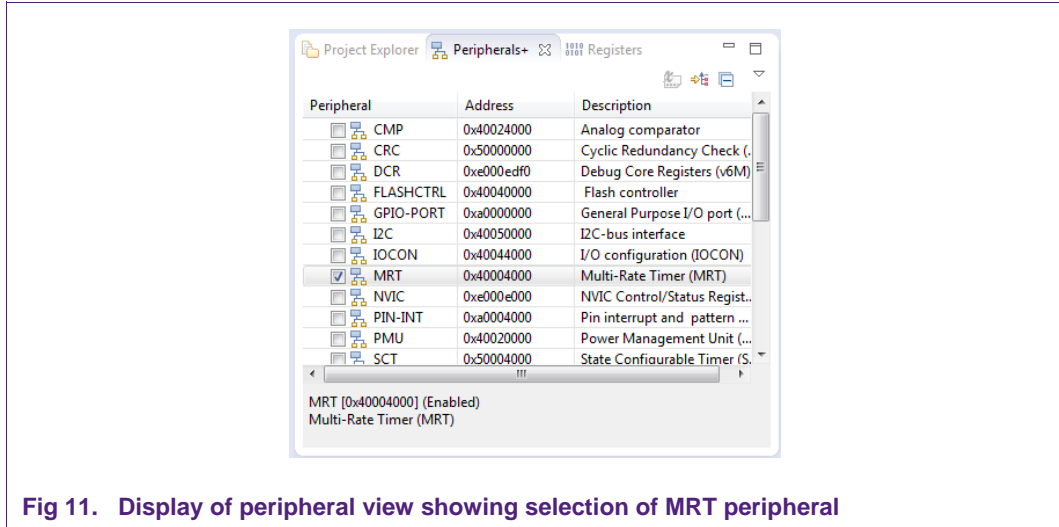

Fig 11. Display of peripheral view showing selection of MRT peripheral

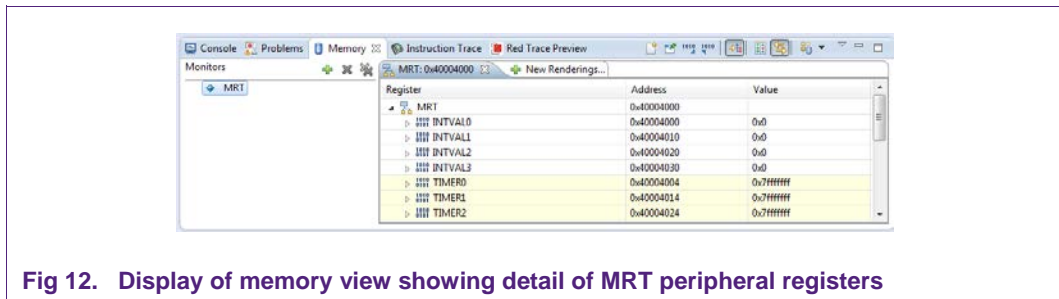

Fig 12. Display of memory view showing detail of MRT peripheral registers

4.2 Connecting the target

To begin development, the LPCXpresso can be connected to a PC using a USB 2.0 A/Mini-B cable.



Fig 13. USB 2.0 A / Mini-B cable

If you are debugging a prototype board or a target containing a different MCU, see the Appendix for a pin-out to connect the debugger section of the LPCXpresso to an external target.

5. Working with example projects

5.1 Downloading NXP sample code from the web

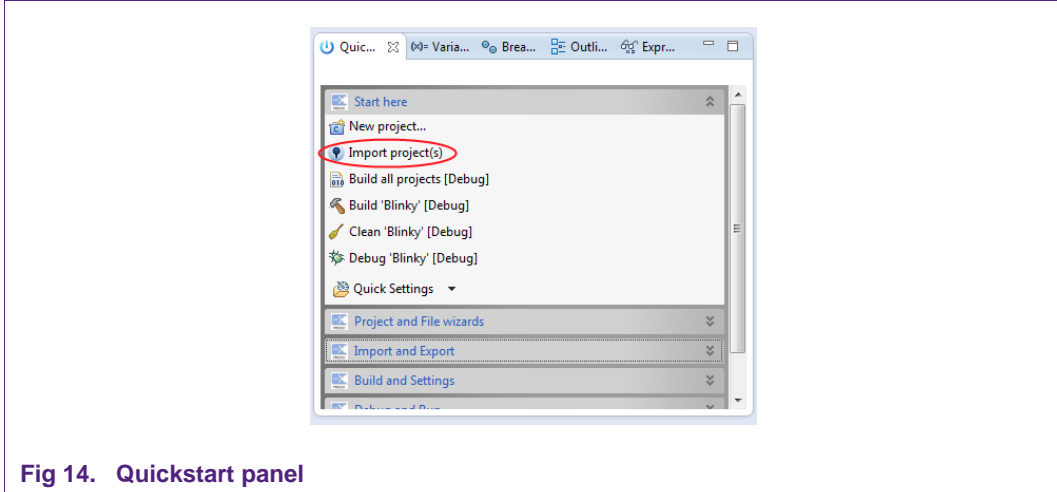

Fig 14. Quickstart panel

The LPCXpresso IDE includes several sample code bundles for various development boards. To work with these projects, select “Import project(s)” from the Quickstart panel in the lower left corner of the screen.

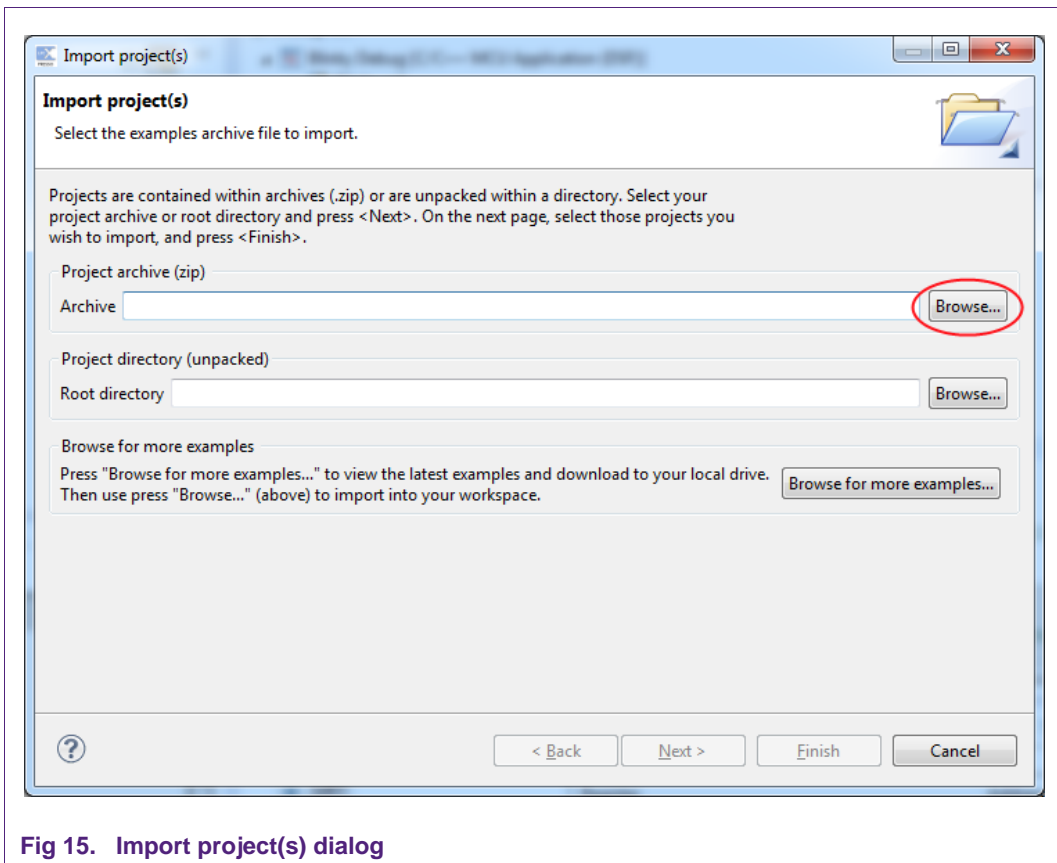

Fig 15. Import project(s) dialog

Next, select “Browse” from the “Project archive (zip)” section of the Import project(s) dialog.

The sample code bundles are located in the directory where the LPCXpresso IDE was installed, under `.\lpcxpresso\Examples\NXP`. Navigate to the sample code bundle that applies to your Target Device and select it.

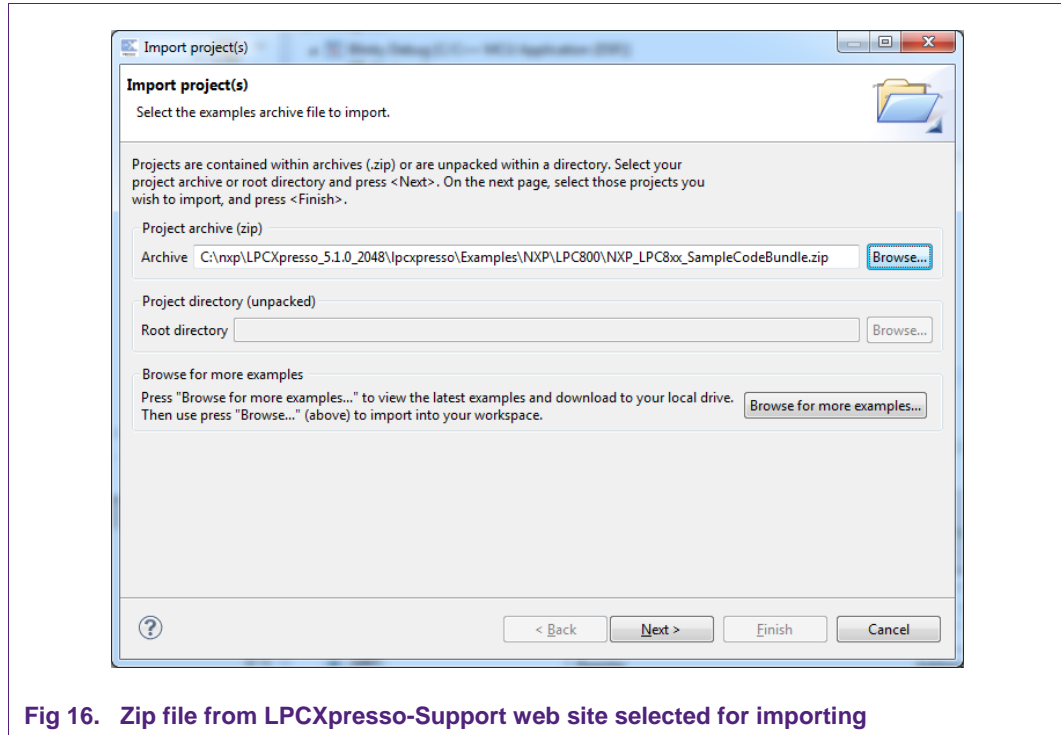

Fig 16. Zip file from LPCXpresso-Support web site selected for importing

Now click the Next button and then choose which projects to import from the .zip file.

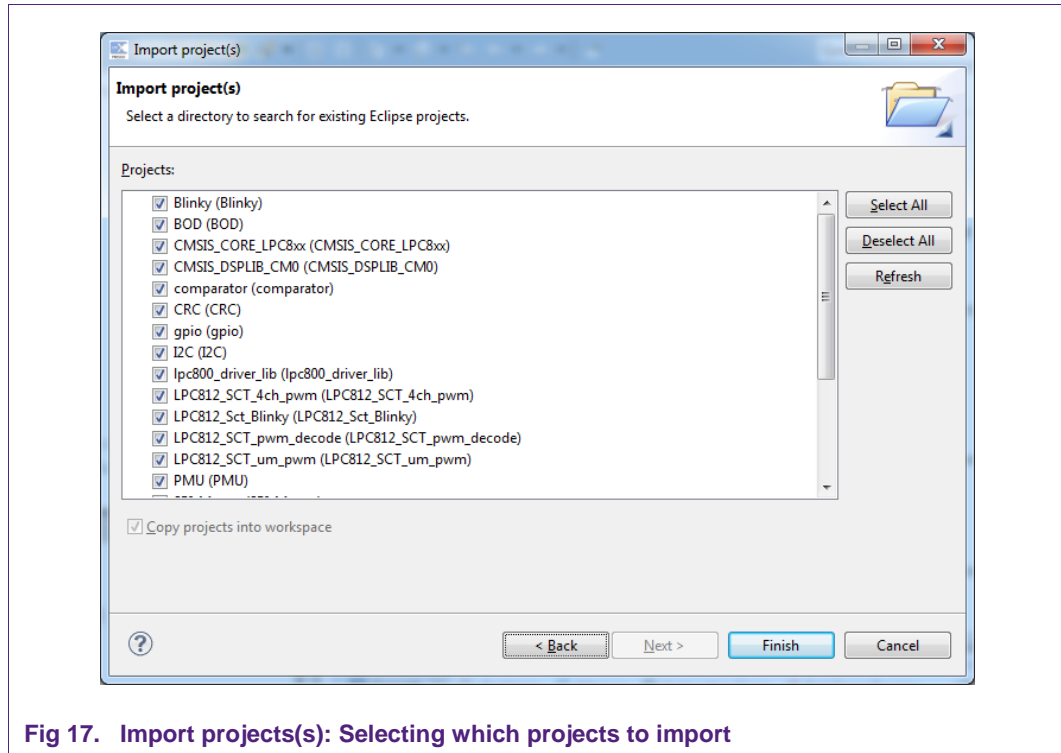

Fig 17. Import project(s): Selecting which projects to import

Often, there will be references between projects in a .zip file so it is best to import all of them.

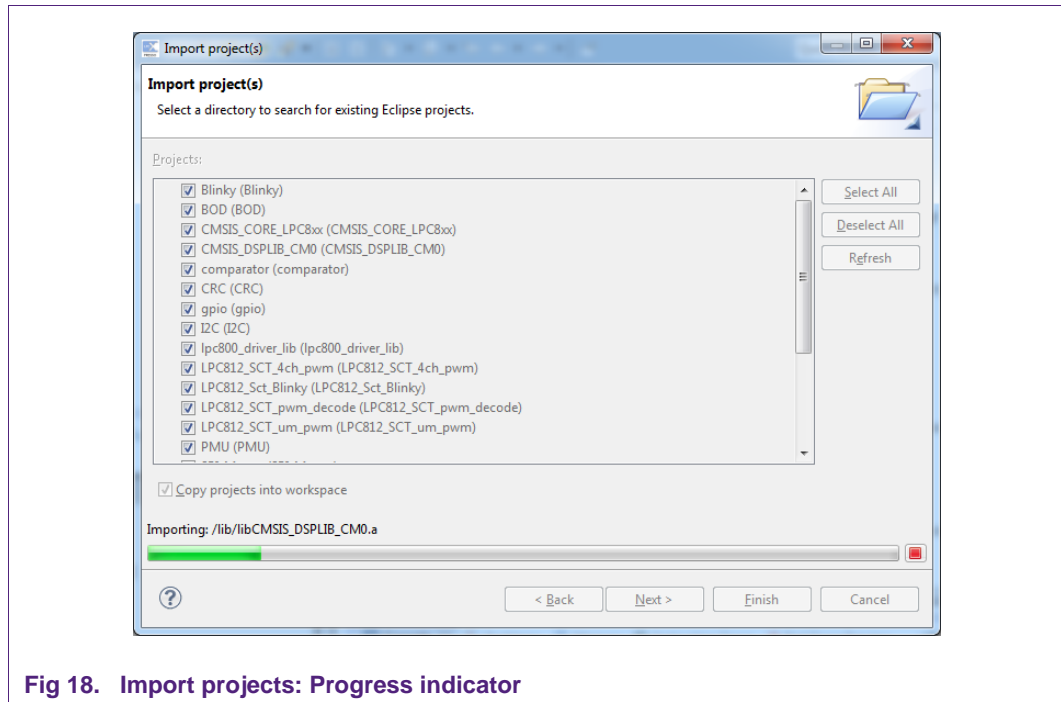

Fig 18. Import projects: Progress indicator

- Updates to the example code bundles can be found at <http://LPCWare.com> between releases of the LPCXpresso IDE.

5.2 Debugging/running 'Blinky' or another project on your LPCXpresso board

In LPCXpresso, when you start to debug, your program will automatically download to the target and be programmed into flash memory.

To start debugging on your target, simply highlight the project in the Project Explorer and then in the Quickstart Panel select 'Debug 'Projectname' [Debug]'.

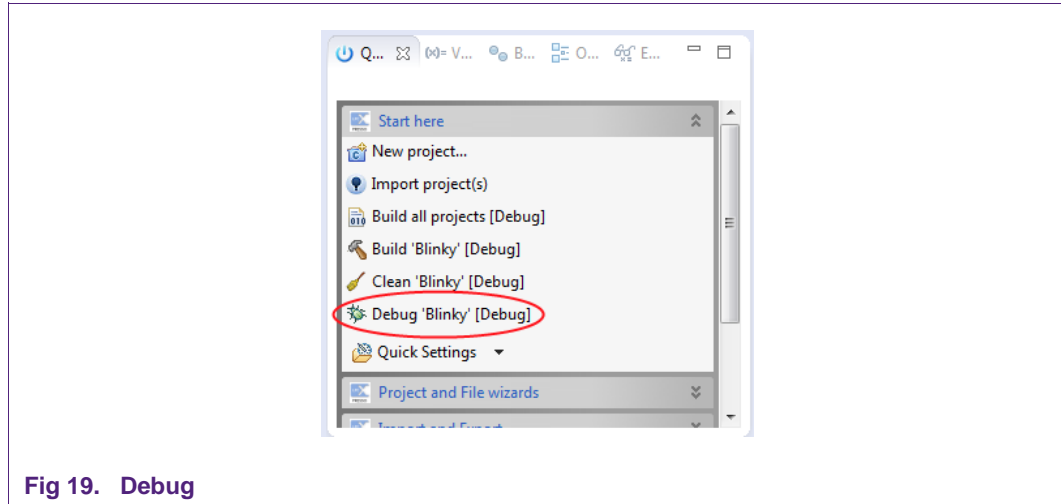

Fig 19. Debug

You may also enter debug mode by clicking the bug icon on the top LPCXpresso toolbar.

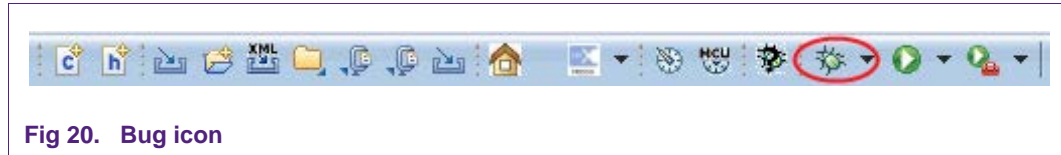

Fig 20. Bug icon

You are then presented with the debug view and toolbar and have run control over the code running on your target. The debug toolbar will pop up above the code window.

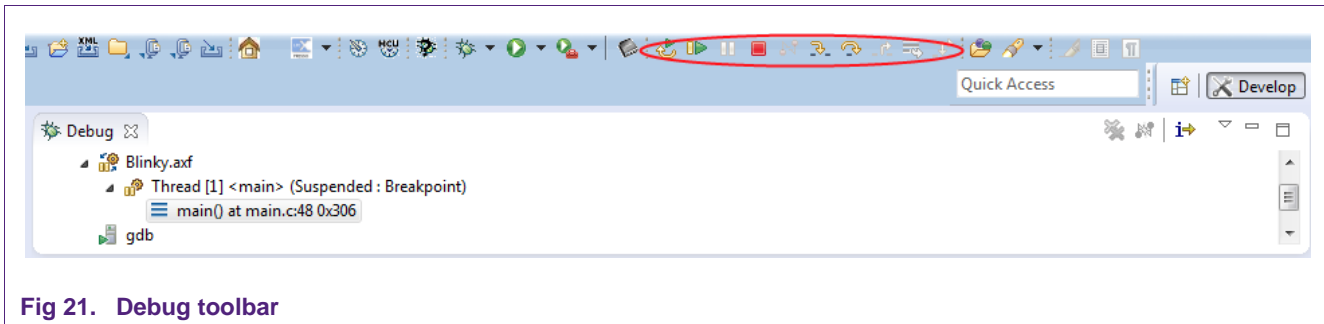
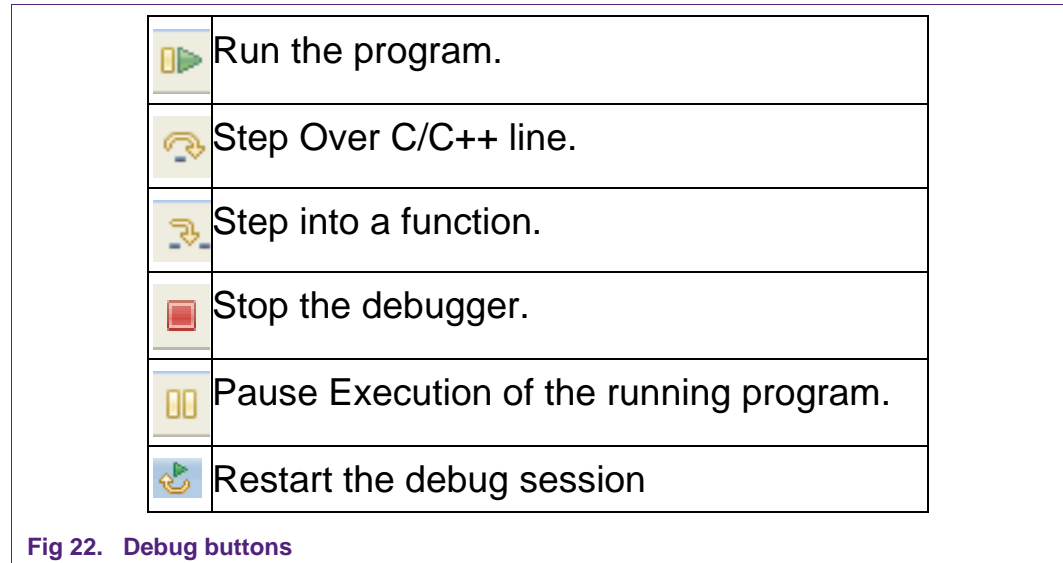

Fig 21. Debug toolbar

You can now do the following with the buttons towards the top of the 'Debug' view:



5.3 Working with Instruction Trace

Instruction trace provides the ability to record and review the sequence of instructions executed on a target. LPCXpresso 5 introduces support for instruction trace via on board trace buffers. Instruction trace makes use of the Embedded Trace Buffer (ETB) on Cortex M3 and M4 parts and the Micro Trace Buffer (MTB) on the Cortex-M0+. The instruction trace which is generated at high speed can be captured in real time and stored in these on-chip buffers, so that they can be downloaded at lower speeds without the need for additional debug hardware.

For information on how to configure LPCXpresso 5 to work with Instruction Trace, please refer to the "Getting Started with Red Trace guide" that is available for download from the Code Red support website:

<http://support.code-red-tech.com/CodeRedWiki/NewInVersion5>

Please note that only the Instruction Trace part of the guide is applicable to the LPCXpresso-IDE.

6. LPCXpresso IDE tips and tricks

6.1 Installing Eclipse plugins

The LPCXpresso IDE contains many of the features of the Eclipse open-source IDE from <http://www.eclipse.org>. The browse and install plugin function is present in the help menu. To access it, choose Help -> Install New Software. This will display the Eclipse Install Software dialog which will allow browsing and installing of Eclipse plugins.

6.2 Debugging tips

6.2.1 Debug features not enabled

All of the LPCXpresso features are context-sensitive. If features are disabled, double-check that you are navigated into a .c file in an open project on the Project Explorer View, or some menu items and toolbar buttons may be disabled. If your workspace

contains projects that create libraries such as CMSIS, please note that debug features will be disabled if you are currently editing a .c file that is part of a library project.

6.2.2 Error launching debugfilename.axf

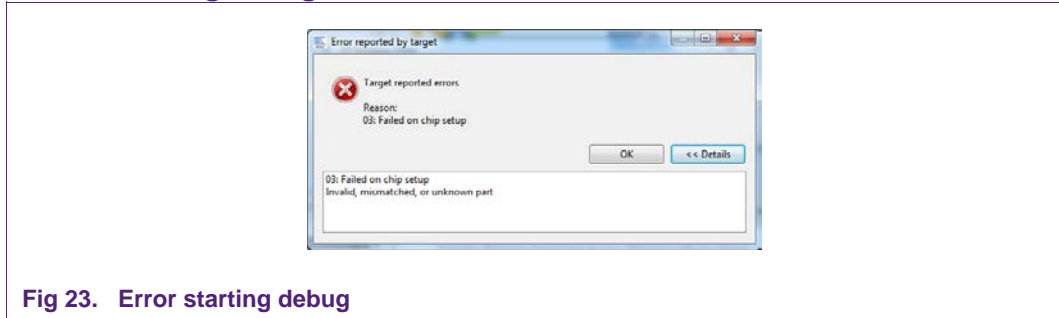

Fig 23. Error starting debug

LPCXpresso checks the target chip ID against the currently selected chip ID for the project and will not start if there is not a match. Make sure that the correct NXP LPC microcontroller part is selected in LPCXpresso. The current part number is displayed in the status bar at the bottom of the LPCXpresso window. It can be changed by holding down the Ctrl key and clicking. A dialog will appear allowing selection of the correct part number.

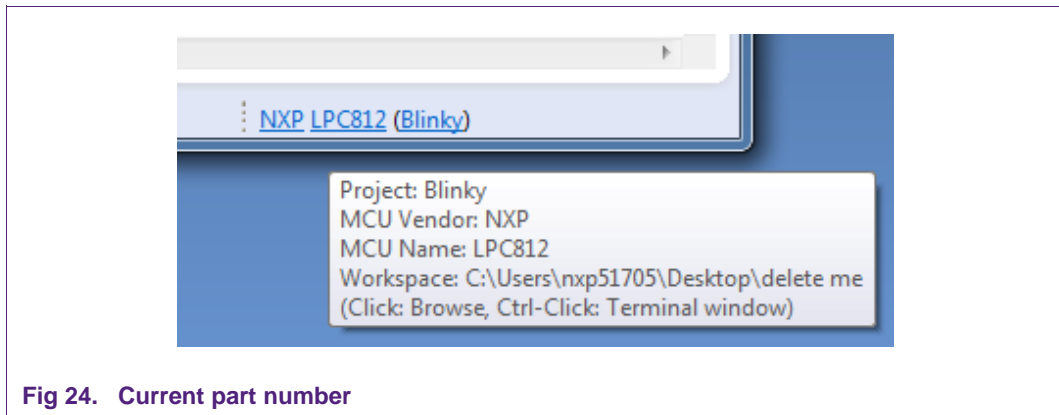

Fig 24. Current part number

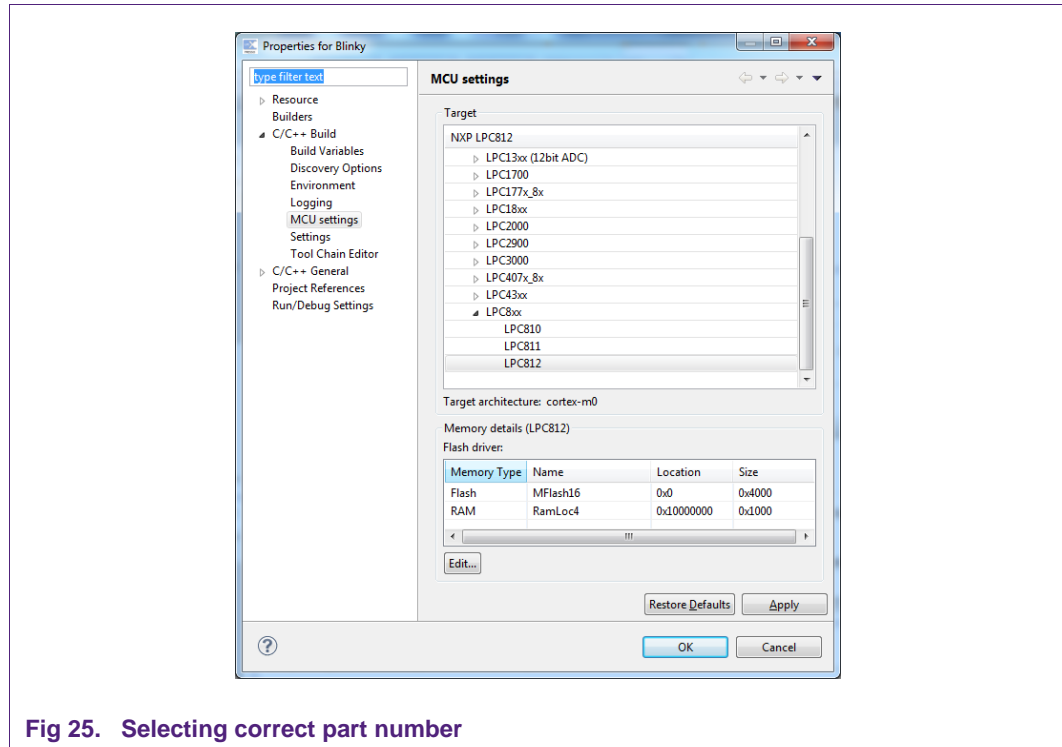

Fig 25. Selecting correct part number

6.2.3 Optimization issues

When optimization is enabled, it will reorder code. What this means is that the code from multiple C lines will be intermingled. In addition, assignments and initializations might be pulled out of loops so they are only executed once. Changes like these will make the code confusing to debug. Some symptoms you might see are breakpoints that only work the first time through, or seeing the debugger's current line indicator fail to advance or even move backwards when you click step. It is best to always use `-O0` for debugging. Since optimization can make such a big difference in code size and performance, it is a good idea to test your project with optimization and plan for a final build that is optimized.

6.2.4 Exiting debug mode and stopping debugging

To stop debug press the 'Stop' button (red square) shown in the toolbar at the top of the debug view.

6.2.5 Recovery of board

After playing around with the LPCXpresso board, especially when trying out new PLL settings, reconfiguring the SWDIO/SWDCLK pin functions, disabling AHBCLKCTRL bits, or trying power down modes, the board may be disabled and no longer enter debug mode. This is caused by code on the on-board flash that incorrectly disables the system clocks or the debug port soon after reset before the debugger can connect to the core. The easiest solution to this is to load a working project into LPCXpresso, ground the ISP pin (see the chip User's Manual for details) and then try to enter debug mode.

Grounding the ISP pin during reset will put the target MCU into In-System Programming (ISP) mode. It will wait for a command through the serial port or the USB port. This temporarily prevents the troublesome code in flash from starting. Although ISP is designed to enable serial and USB updates, while ISP is running, the LPCXpresso toolchain is able to connect to the Cortex core and reprogram the flash. After the flash is

reprogrammed, disconnect the ISP pin (pull it high or allow it to float) and stop debugging. Now you should be able to debug code again.

6.3 Datasheet browser

The LPCXpresso IDE comes with an integrated web browser that will direct viewers to the datasheet of the device. Just click on the part number in the lower right border of the LPCXpresso window to see the browser in action.

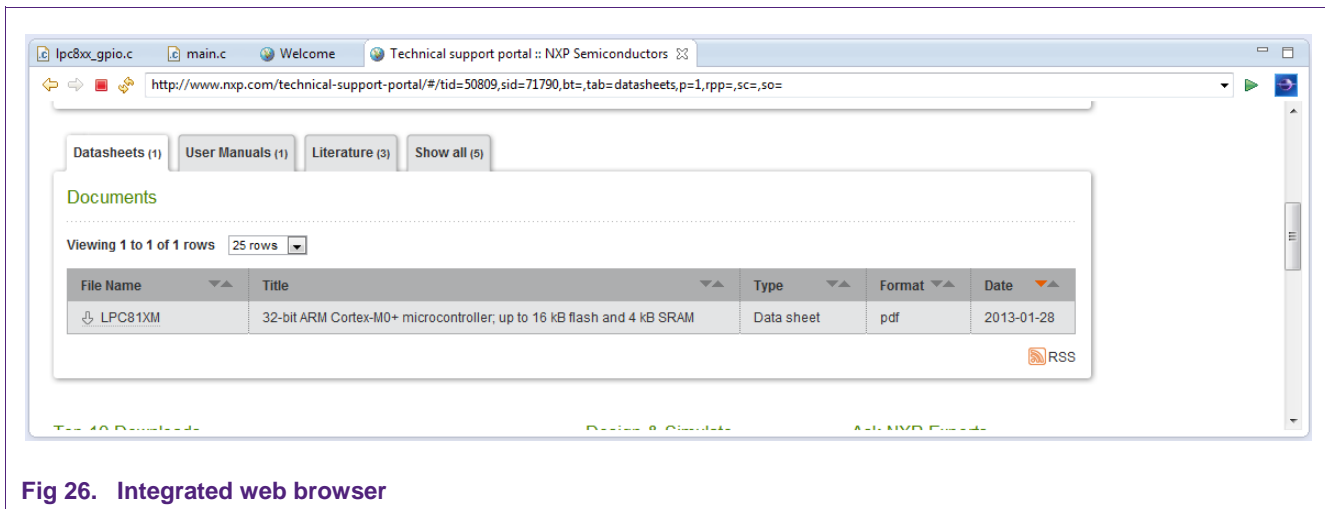

Fig 26. Integrated web browser

6.4 Code size

6.4.1 printf

When optimizing a project for size, if you are using printf, make sure that Redlib is selected as the standard library in the Projects Properties dialog. This option can be set using the Quick Settings dropdown box in the Quick Start panel.

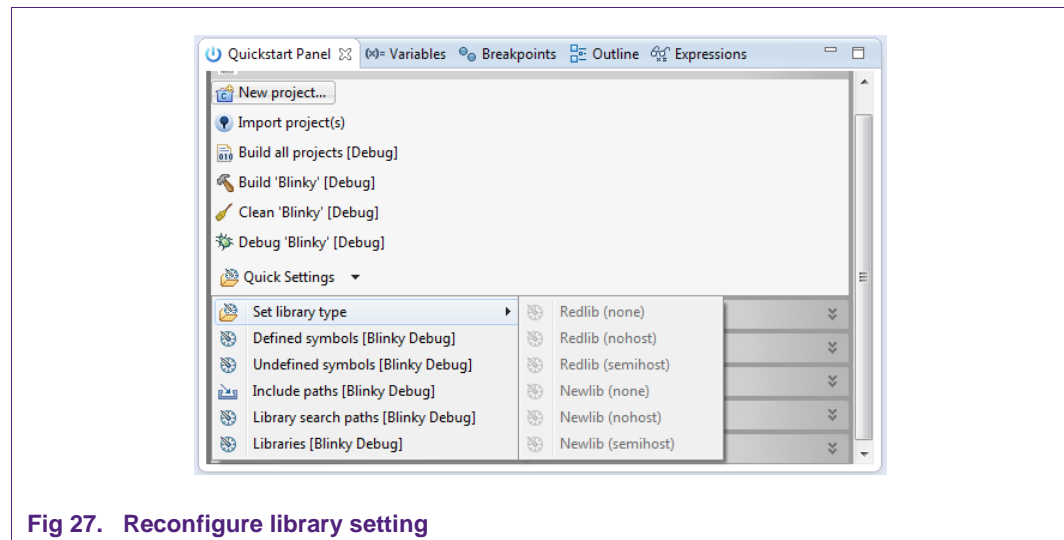

Fig 27. Reconfigure library setting

The printf implementation in Redlib is about half the size of the implementation in Newlib. A smaller printf library can be used in Redlib if floating point formatting strings are not used. To select this smaller library, define the symbol CR_INTEGER_PRINTF to the compiler (i.e. -DCR_INTEGER_PRINTF). To save even more space, avoid using printf or

any C standard library functions and select Redlib (none). Depending on your printf settings and code, this could free up 10K to 20K of flash memory.

6.4.2 Optimization

Optimization can do a lot to save flash memory. It can be configured in the same dialog as the C standard library. Choose “Optimization” under “MCU C Compiler” in the “Tool Settings” tab. Higher levels of optimization will typically result in higher performance, but may result in larger code size. It is best to use `-O0` for debugging and higher levels for Release. For best code size try `-Os -mword-relocations`. To further reduce code, add `--gc-sections` to the project linker flags. This causes the linker to remove unused functions from the compiled code. `--gc-sections` is enabled by default in new projects created by the project wizard. If you are working with an existing project, you may need to manually add this option to your project. `--gc-sections` is safe to use in both Release and Debug builds. There are many optimization options available for GCC. Visit <http://gcc.gnu.org/onlinedocs/gcc/Optimize-Options.html> to see all of them.

6.5 Showing hidden views

A view is an on-screen representation of something in the IDE. A view can be source code, the project tree, or a debug window. If you accidentally close a view, you can open it again by going to the Window menu and choosing Show View and Other. It is a good idea to browse through the Show View window to see what is available.

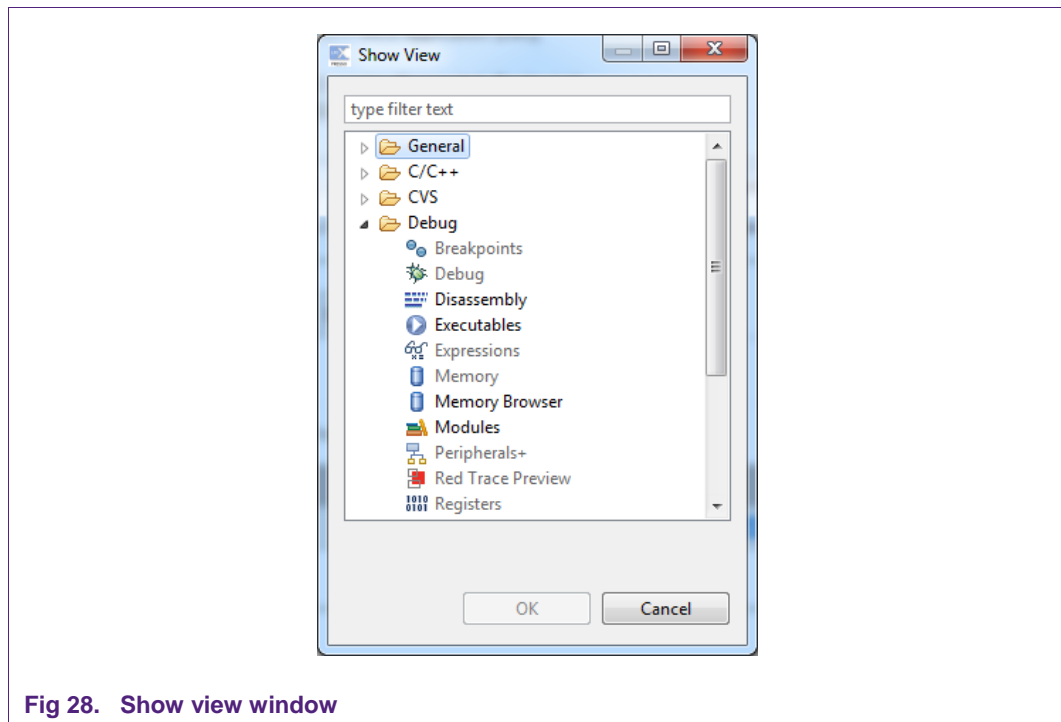

Fig 28. Show view window

This will present a dialog allowing you to pick a view and display it.

6.6 Creating a ‘skeleton’ project in a new Workspace

LPCXpresso includes several project Templates to help get started quickly.

6.6.1 Create a new Workspace

From the 'File' menu hover over 'Switch Workspace' and then select 'Other...' from the bottom of the list. You will then see the 'Workspace Launcher' dialog shown below.

Enter or browse to the new path for your workspace. We have called our new workspace 'NewWorkspace'.

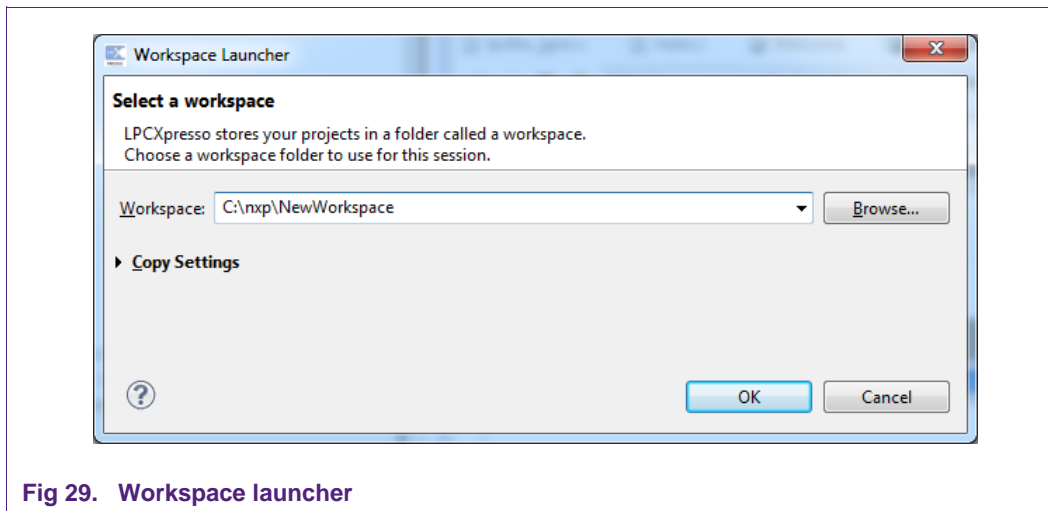

Then click on OK to re-open LPCXpresso with this new workspace selected.

6.6.2 Create the 'Skeleton' project

- If you are using a Cortex-based part, first, import the CMSIS header files for the chip family you are planning to work with. To do this, click "Import Project" and navigate to the CMSIS<version/part>.zip. The CMSIS header files are installed with LPCXpresso in C:\nxp\lpcxpresso\lpcxpresso\examples\nxp. Once this project is added to your workspace, click "Build all projects (Debug)" in the Quickstart Panel.
- Click on 'New project...' and select the NXP C project type for your architecture.
- Click "Next" and enter a project name. In this case we will use 'MyProject' then click 'Next.'

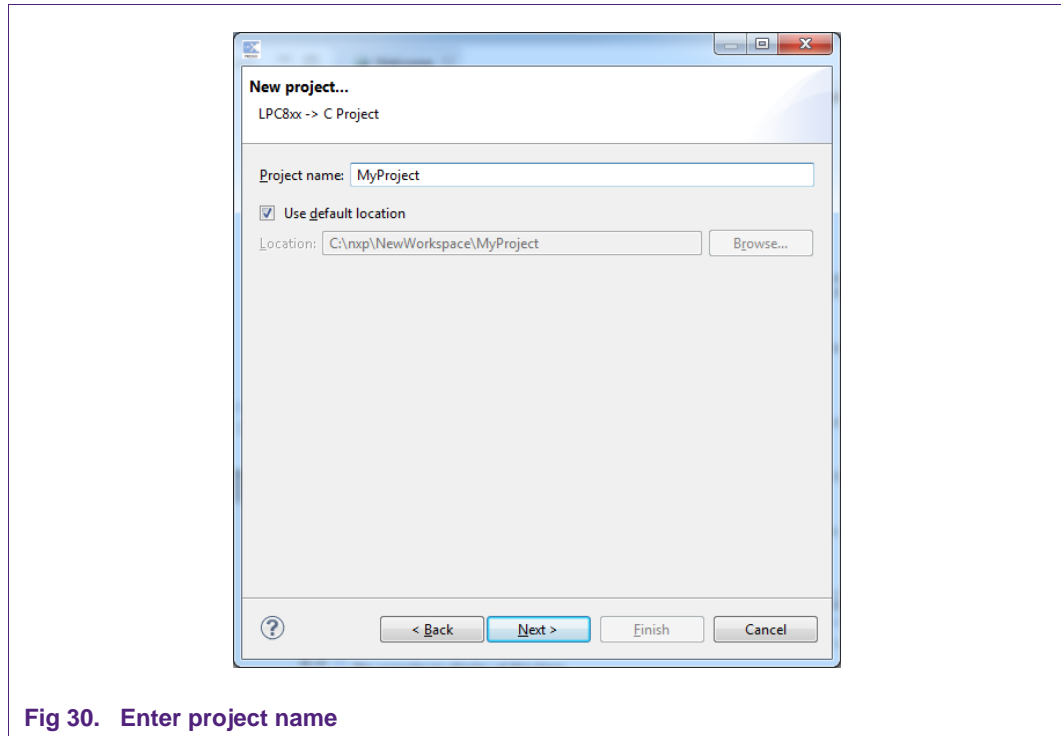

Fig 30. Enter project name

- The next section of the dialog will ask you to specify which chip in the family you are using.

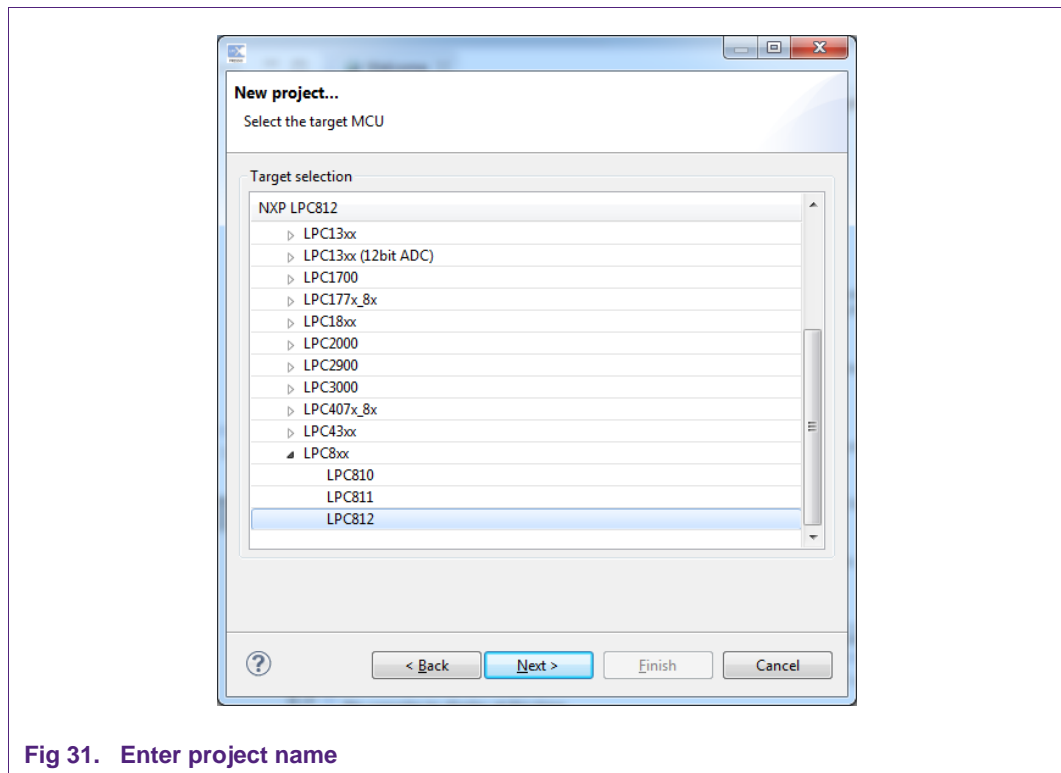

Fig 31. Enter project name

- If you are using a Cortex-based part, the next step in the wizard will ask which CMSIS project to use. CMSIS stands for Cortex Microcontroller Software Interface Standard. CMSIS defines a common way to access peripheral registers and to define interrupts. Please select the project that you imported into the workspace earlier and click Finish.

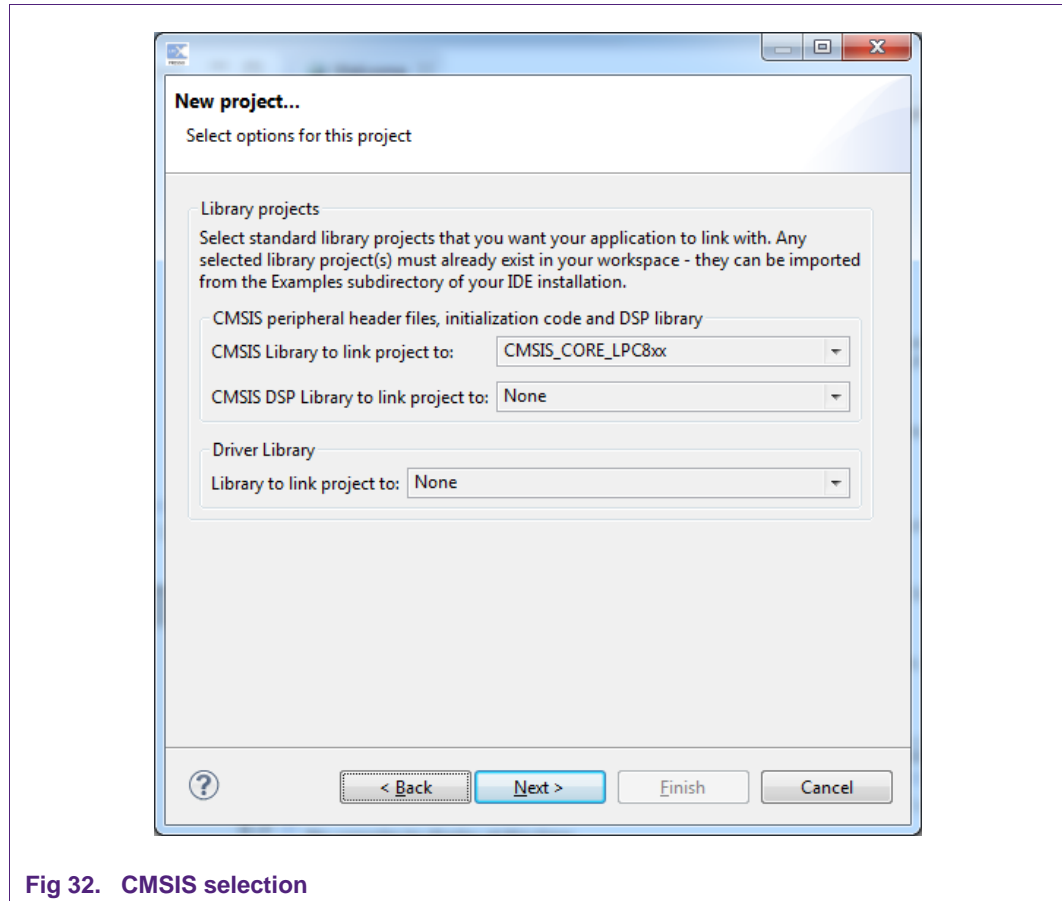

Fig 32. CMSIS selection

Congratulations! You have created your first project!

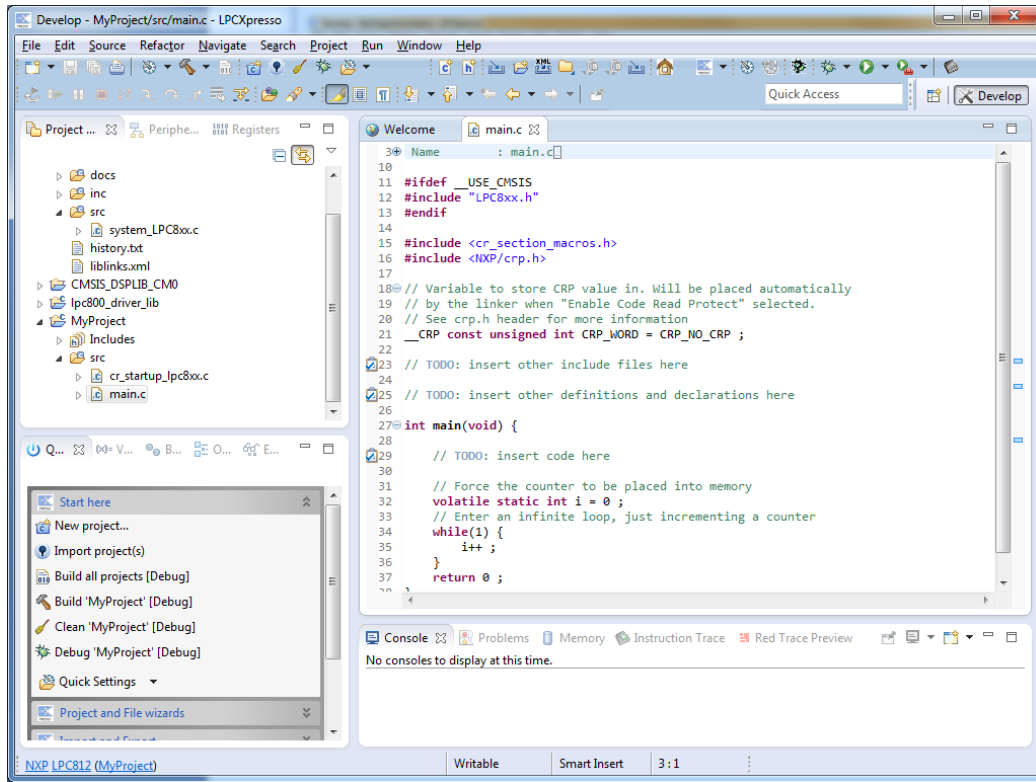

Fig 33. Project creation complete

7. Appendix

7.1 LPCXpresso target side schematics

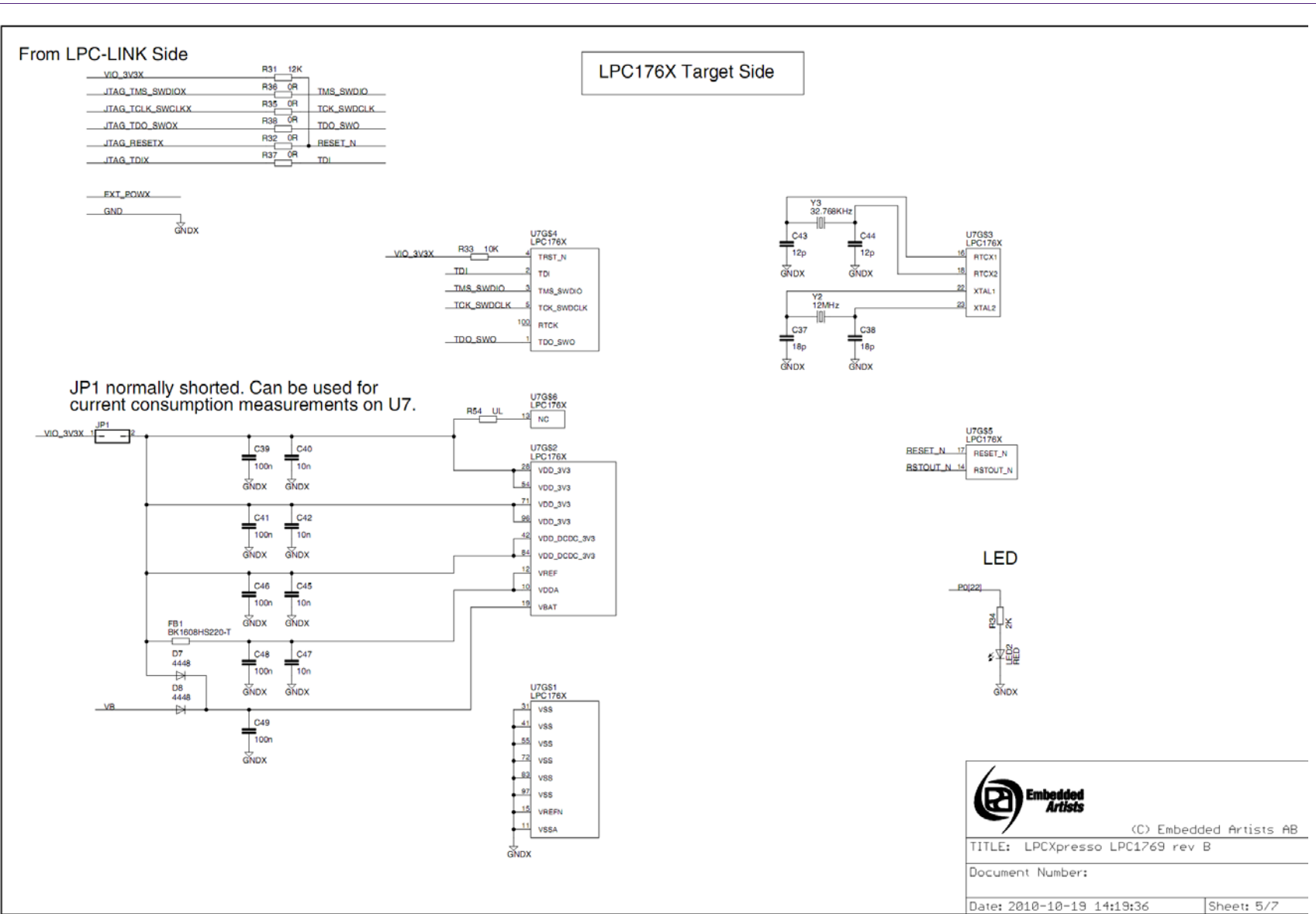

Fig 34. Schematic for the LPCXpresso LPC1769 target side (1 of 3)

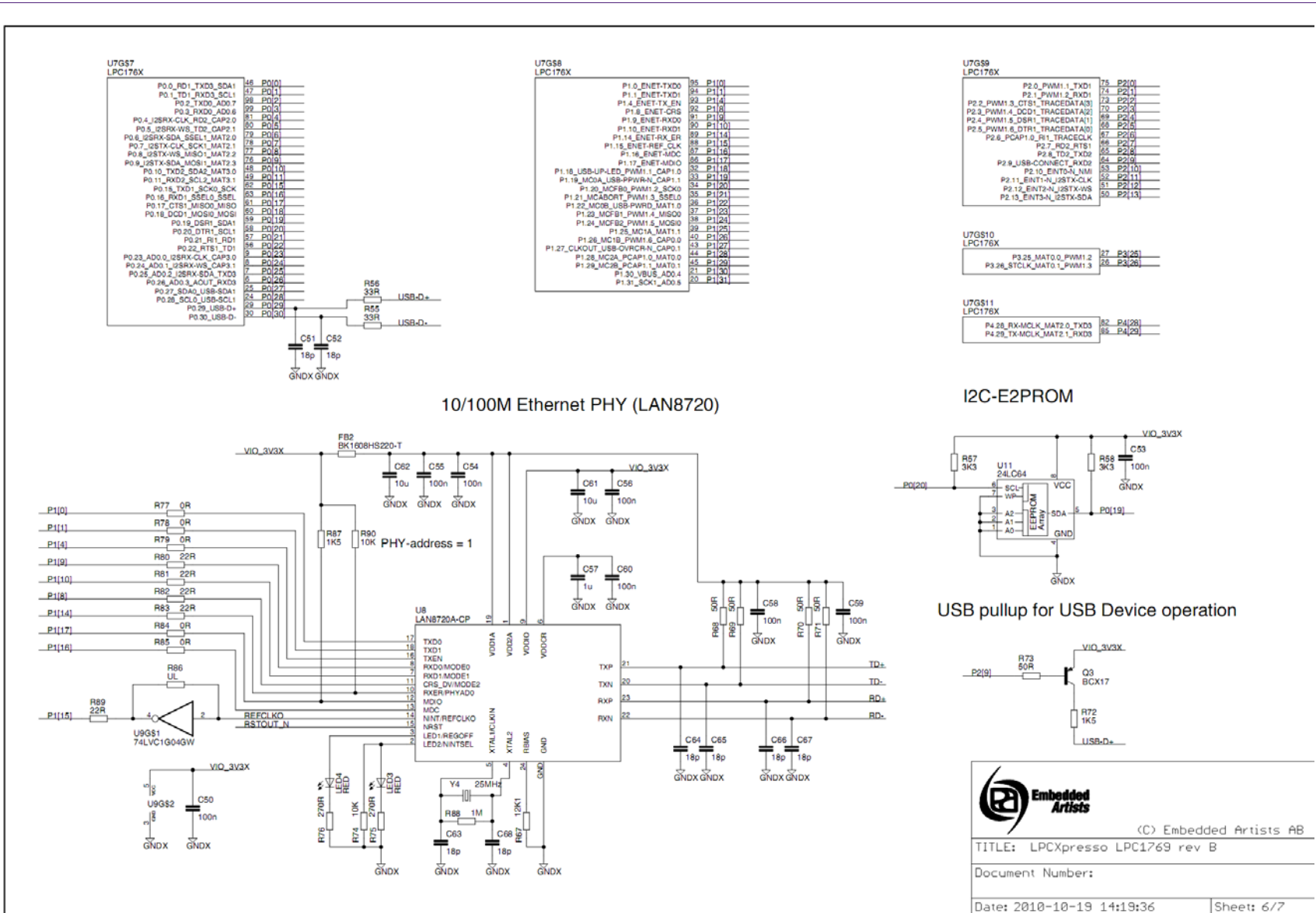

Fig 35. Schematic for the LPCXpresso LPC1769 target side (2 of 3)

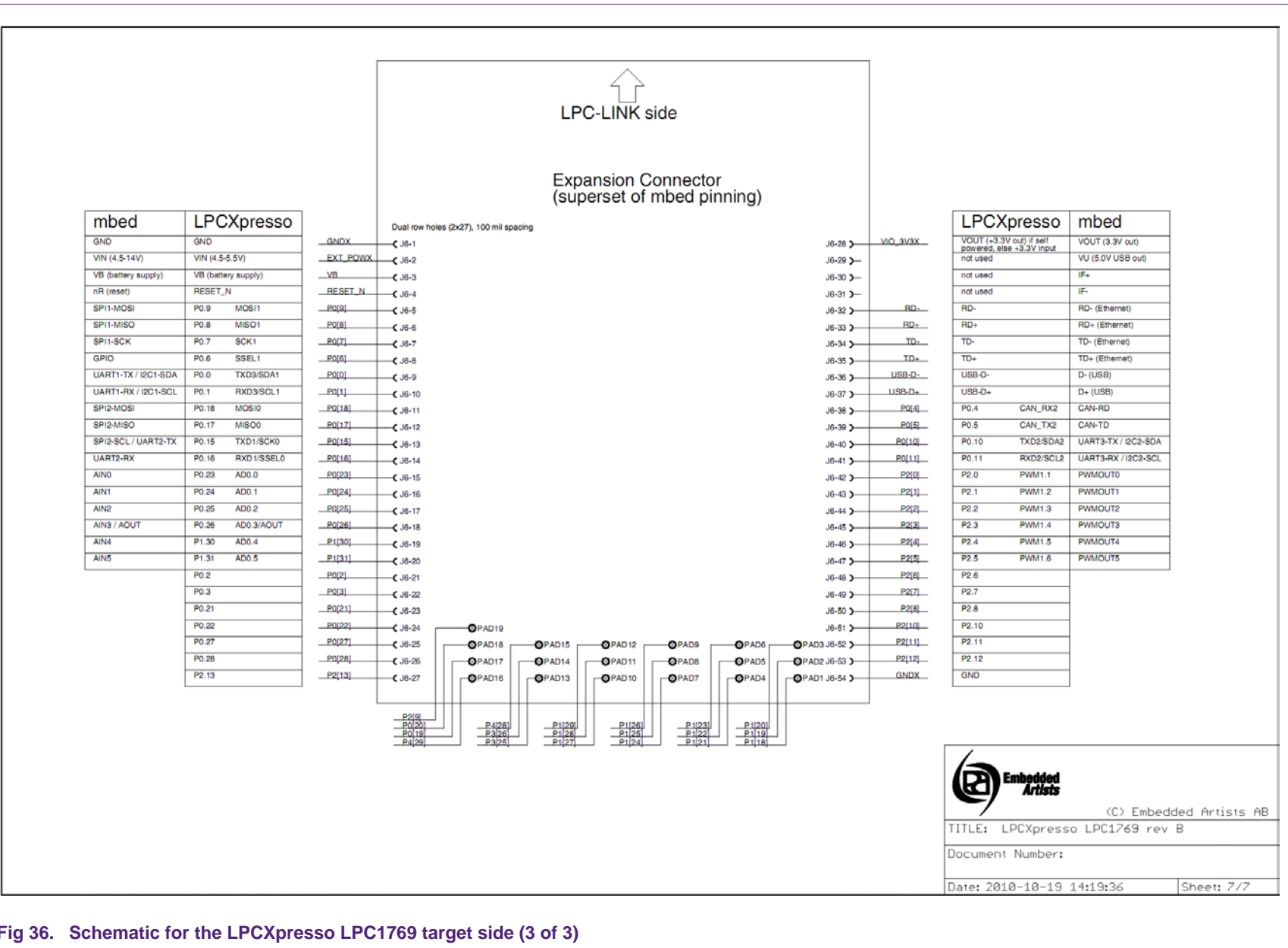

Fig 36. Schematic for the LPCXpresso LPC1769 target side (3 of 3)



(C) Embedded Artists AB

TITLE: LPCXpresso LPC1769 rev B

Document Number:

Date: 2010-10-19 14:19:36

Sheet: 7/7

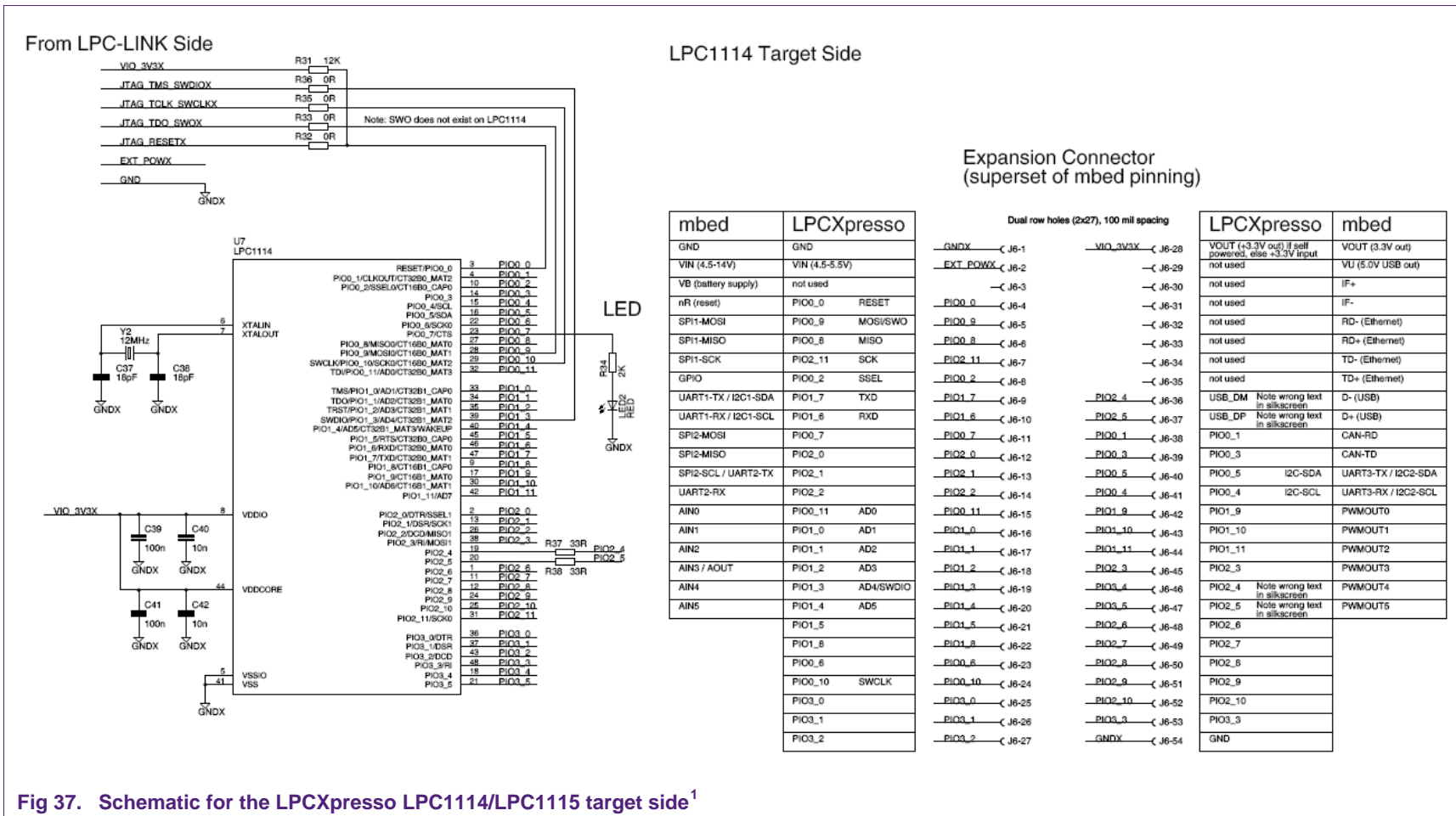

Fig 37. Schematic for the LPCXpresso LPC1114/LPC1115 target side¹

1. 1. Design and layout compatible with LPC1343 version. Therefore, PIO2_4/5 and PIO3_4/5 swap. LPC1114 does not have USB, but LPC1343 does. Therefore R37/38. LPC1114 does not have SWO, but PIO0_9 is connected (since LPC1343 has SWO there). Recent versions of this board use a LPC1115 in place of the LPC1114.

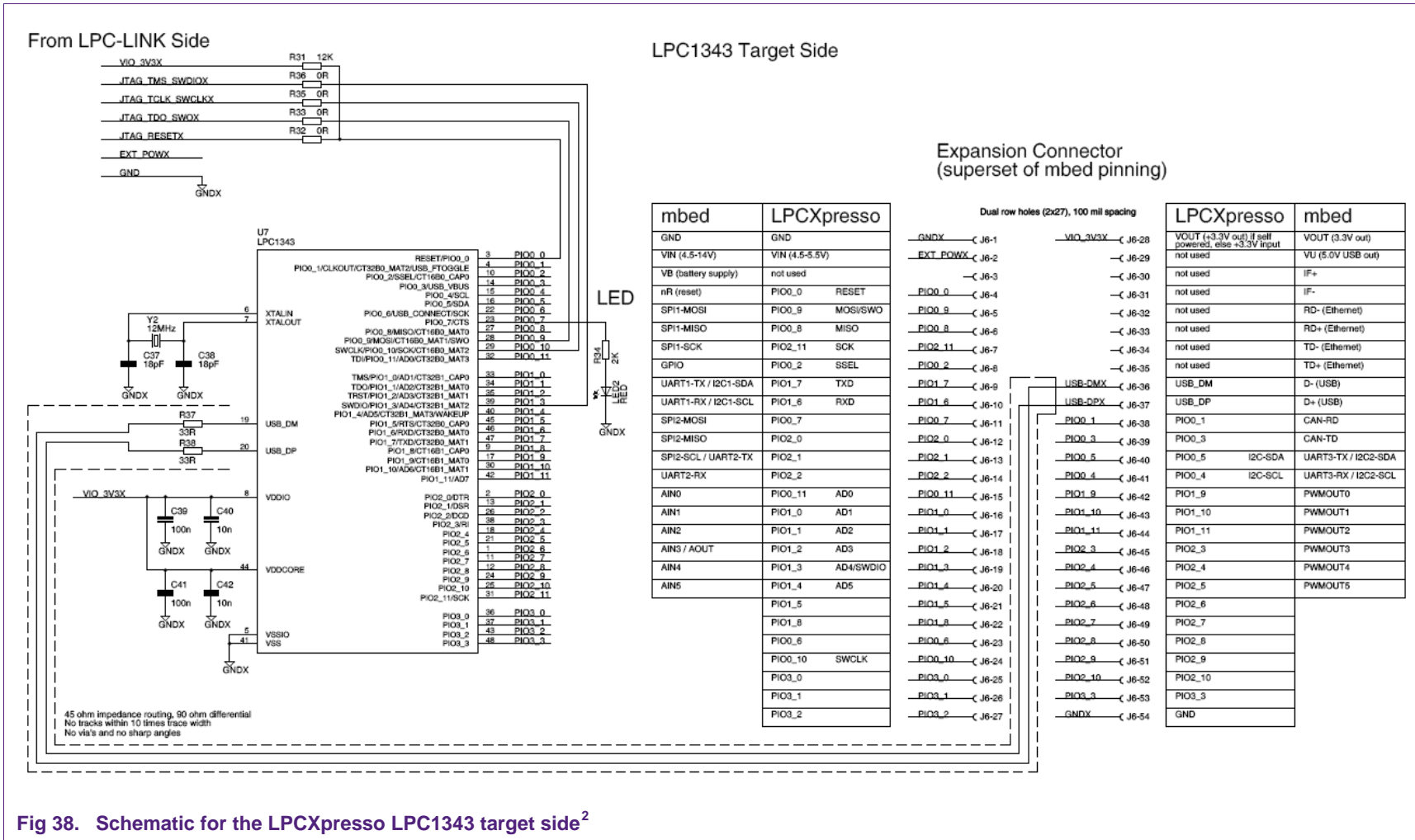

Fig 38. Schematic for the LPCXpresso LPC1343 target side²

2. This board has been replaced with the LPC1347-LPCXpresso board.

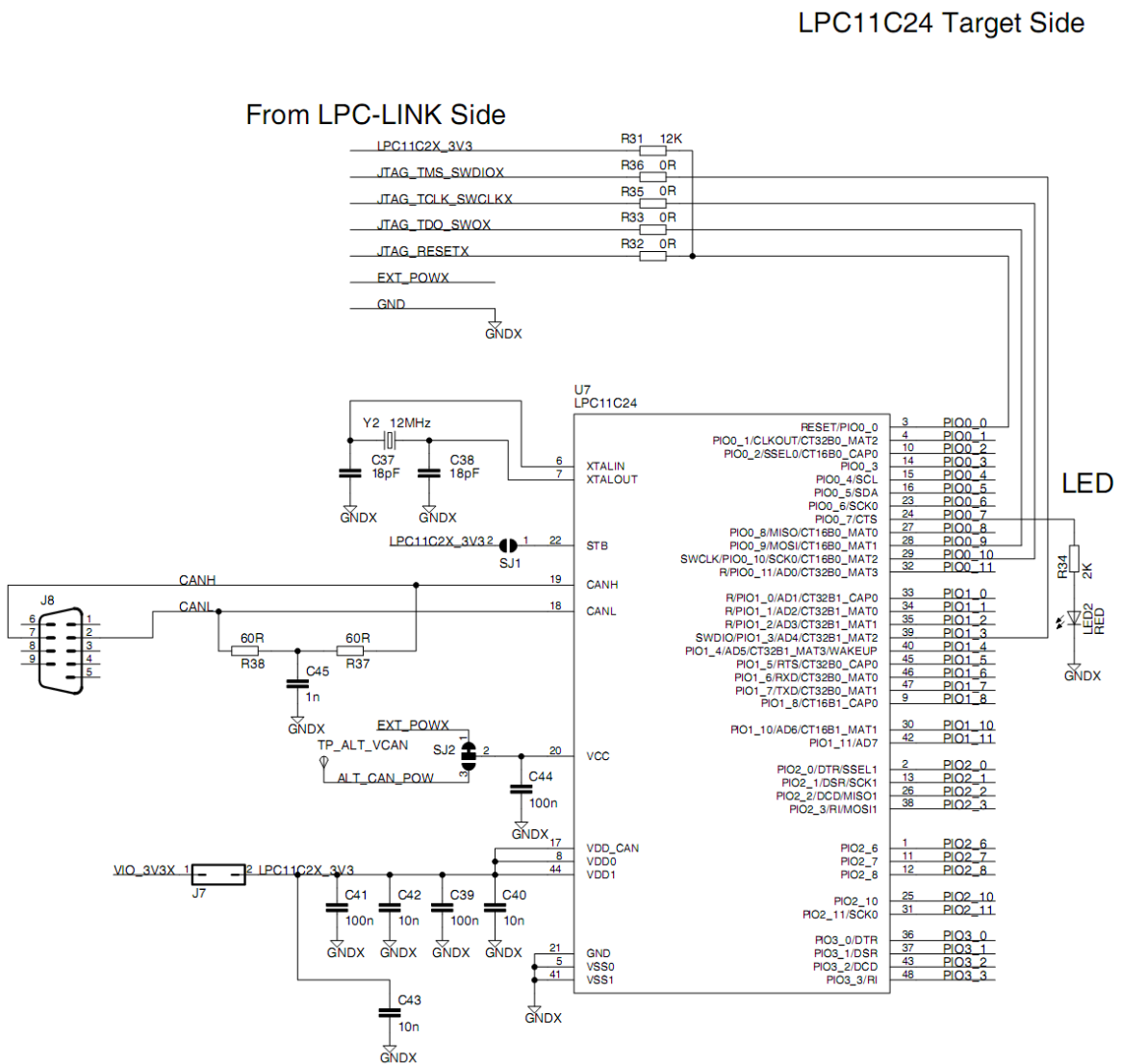

Fig 39. Schematic for the LPCXpresso LPC11C24 target side (1 of 2)

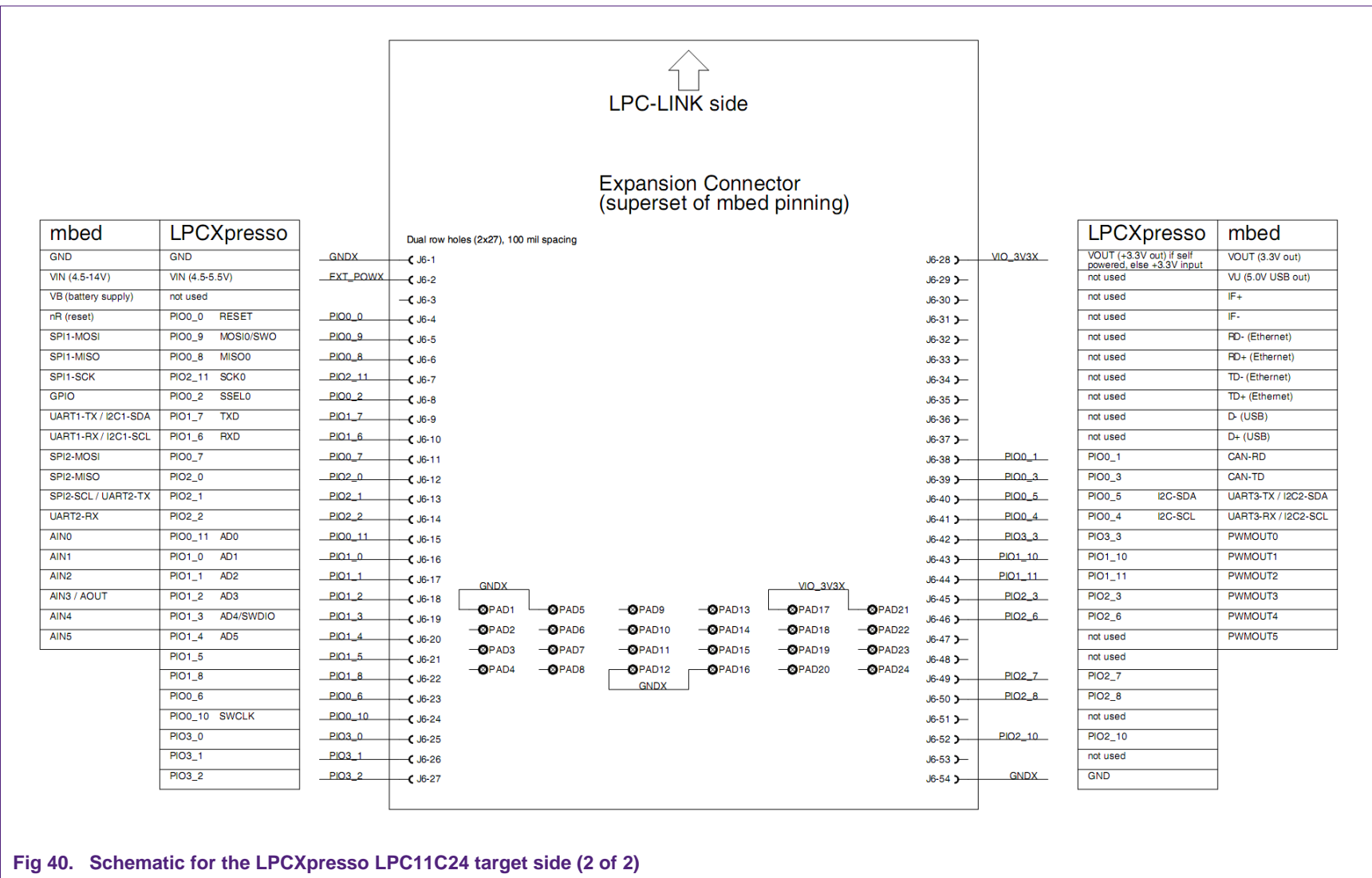

Fig 40. Schematic for the LPCXpresso LPC11C24 target side (2 of 2)

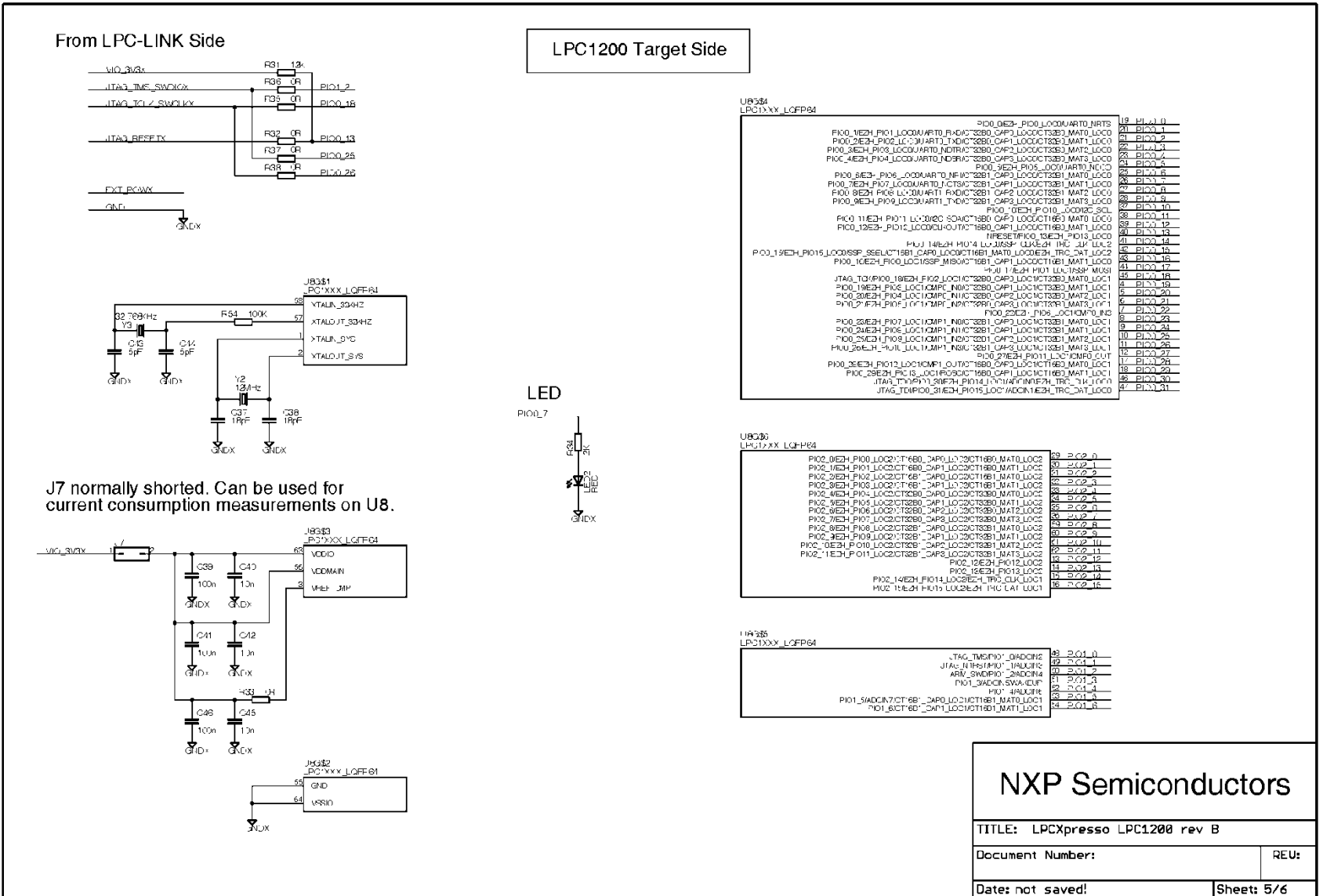

Fig 41. Schematic for the LPCXpresso LPC1200 target side (1 of 2)

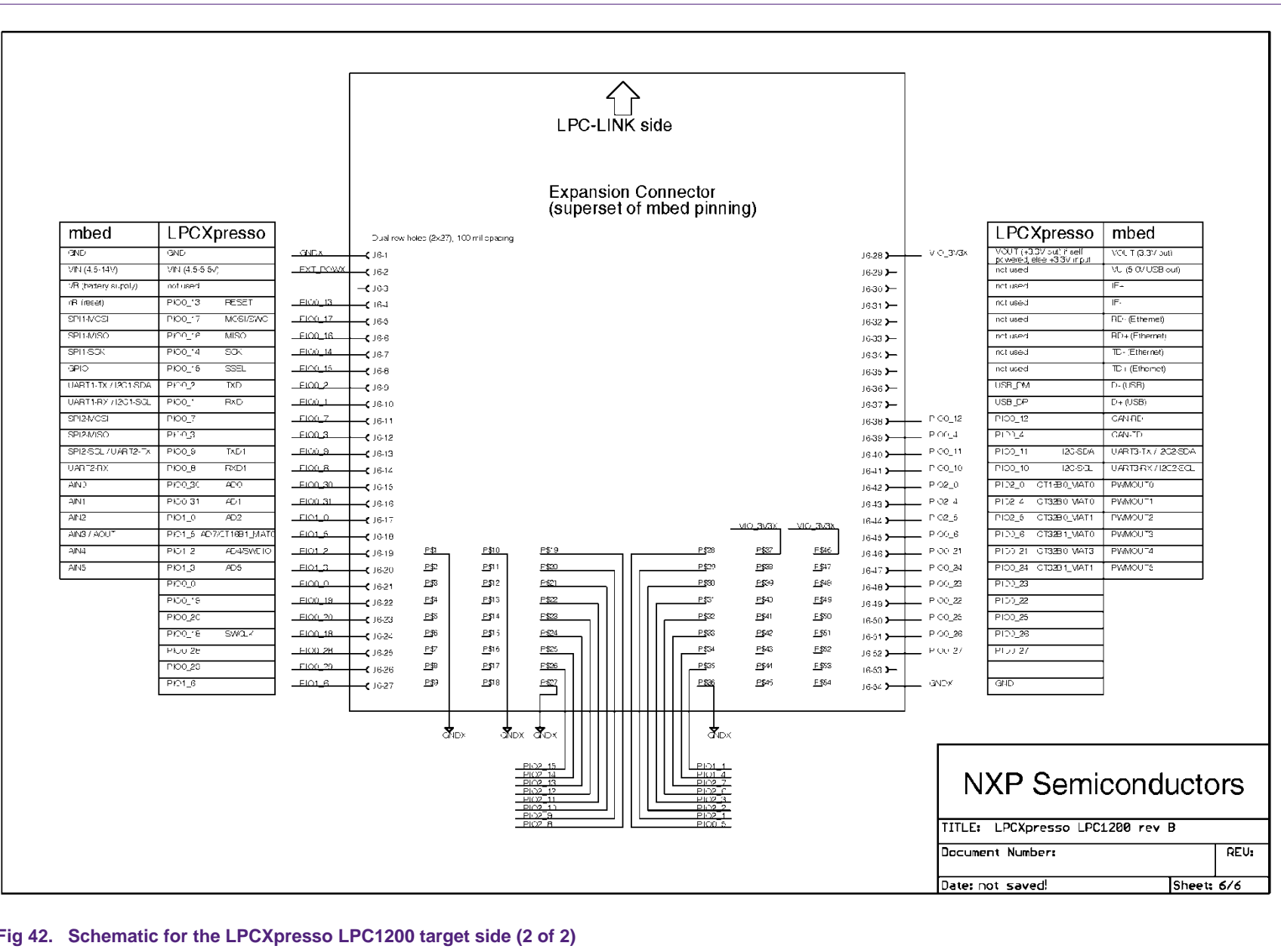

Fig 42. Schematic for the LPCXpresso LPC1200 target side (2 of 2)

NXP Semiconductors

TITLE: LPCXpresso LPC1200 rev B

Document Number:

REV:

Date: not saved!

Sheet: 6/6

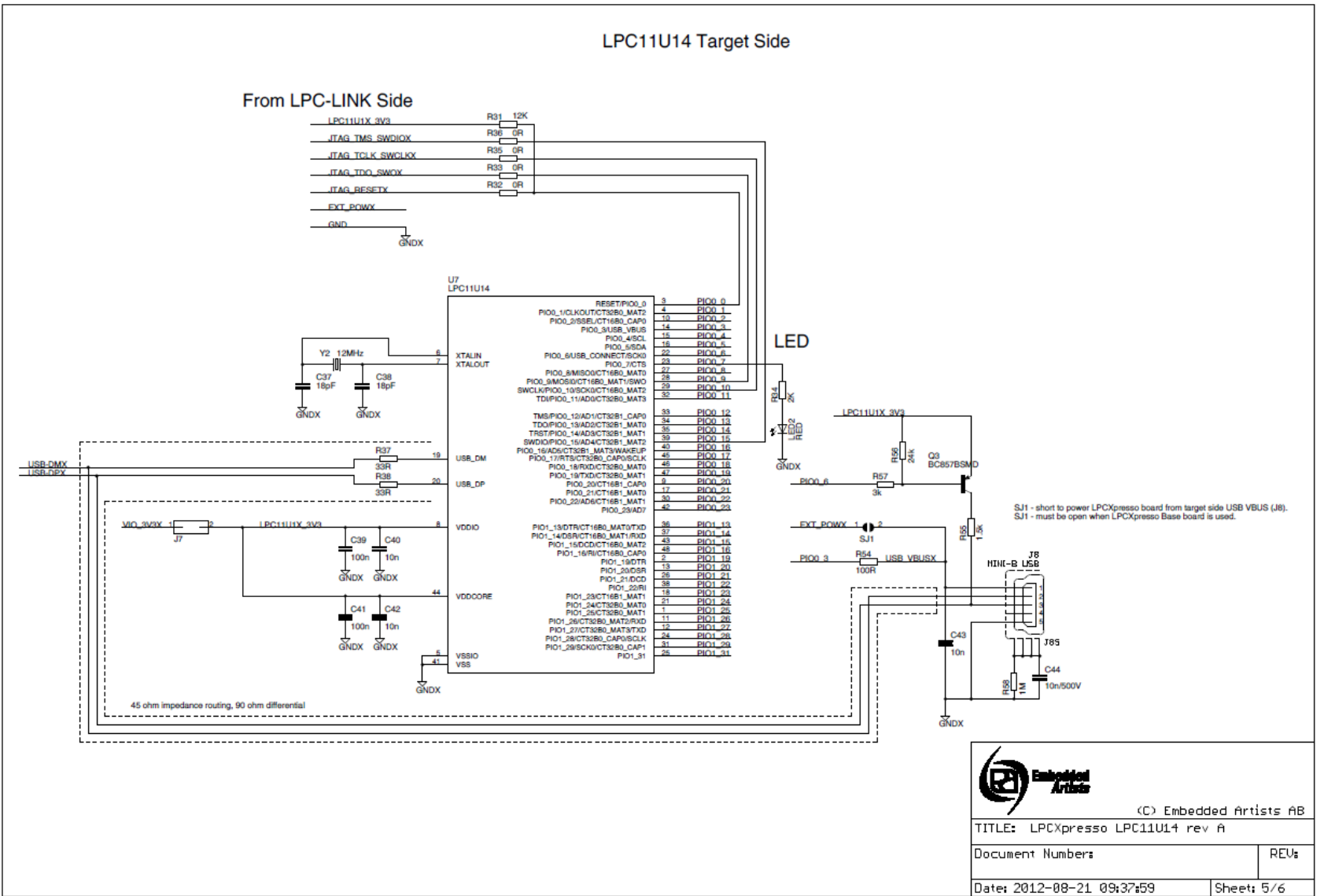

Fig 43. Schematic for the LPCXpresso LPC11U14 target side (1 of 2)

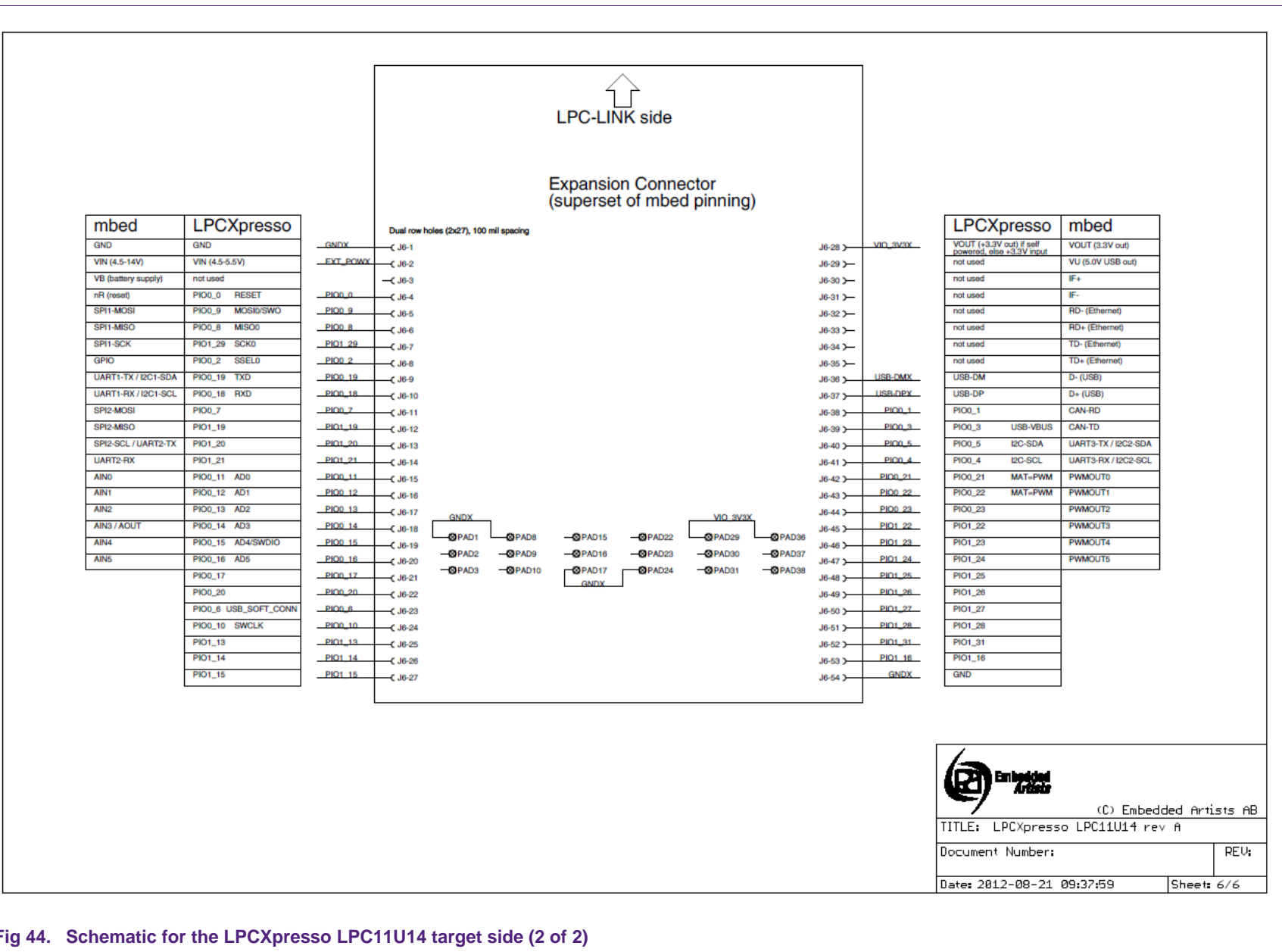

Fig 44. Schematic for the LPCXpresso LPC11U14 target side (2 of 2)

(C) Embedded Artists AB

TITLE: LPCXpresso LPC11U14 rev A

Document Number: REV:

Date: 2012-08-21 09:37:59 Sheet: 6/6

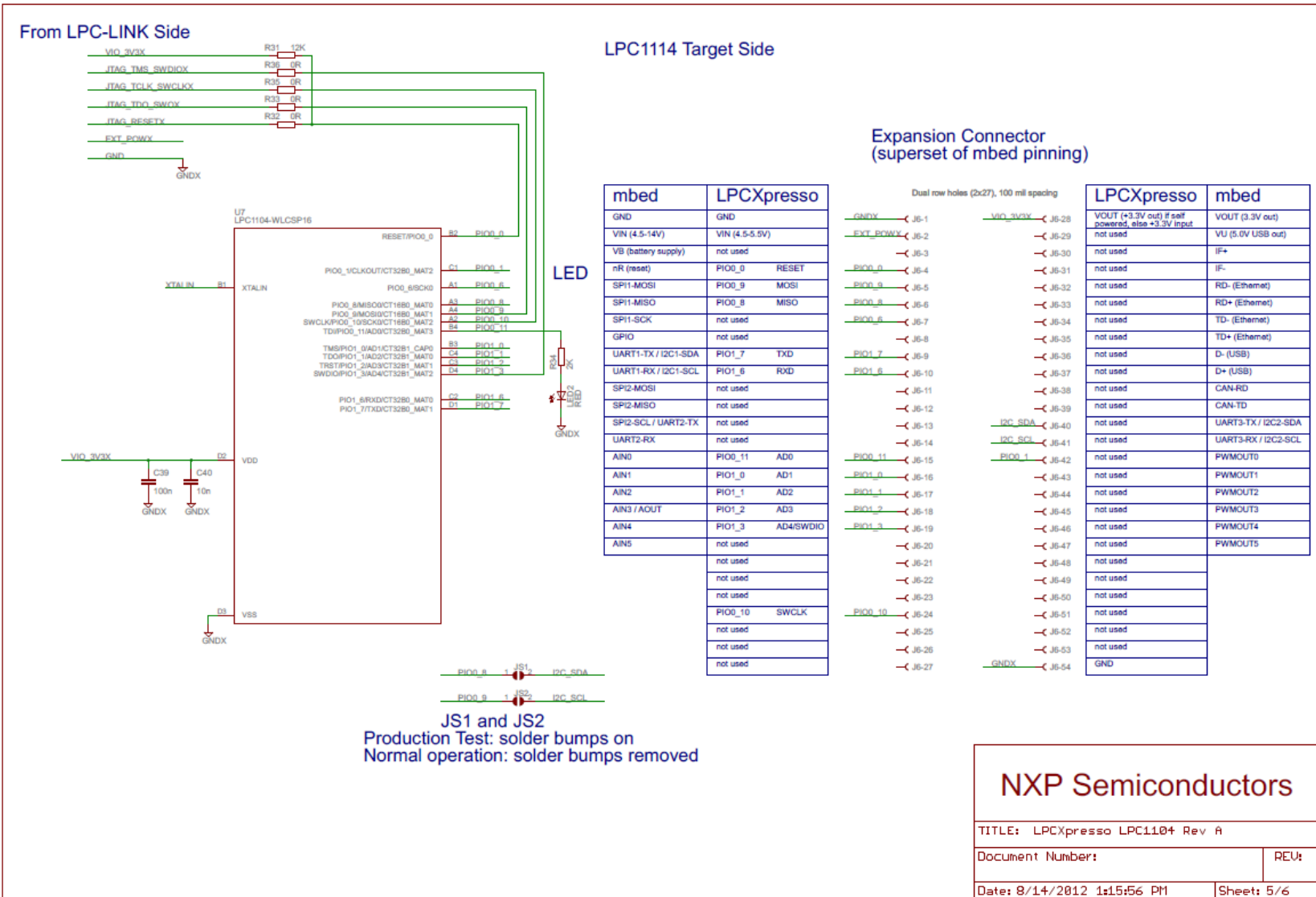

Fig 45. Schematic for the LPCXpresso LPC1104 target side (1 of 2)

NXP Semiconductors	
TITLE: LPCXpresso LPC1104 Rev A	
Document Number:	REV:
Date: 8/14/2012 1:15:56 PM	Sheet: 6/6

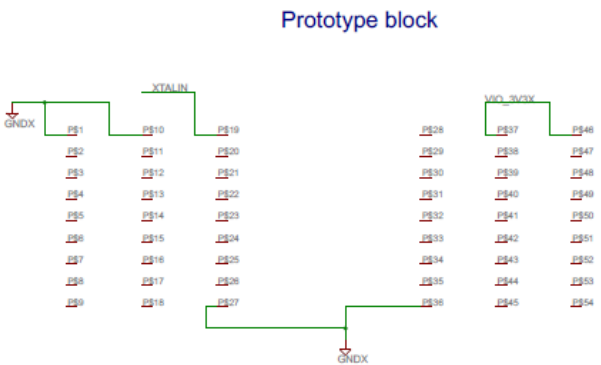

Fig 46. Schematic for the LPCXpresso LPC1104 target side (2 of 2)

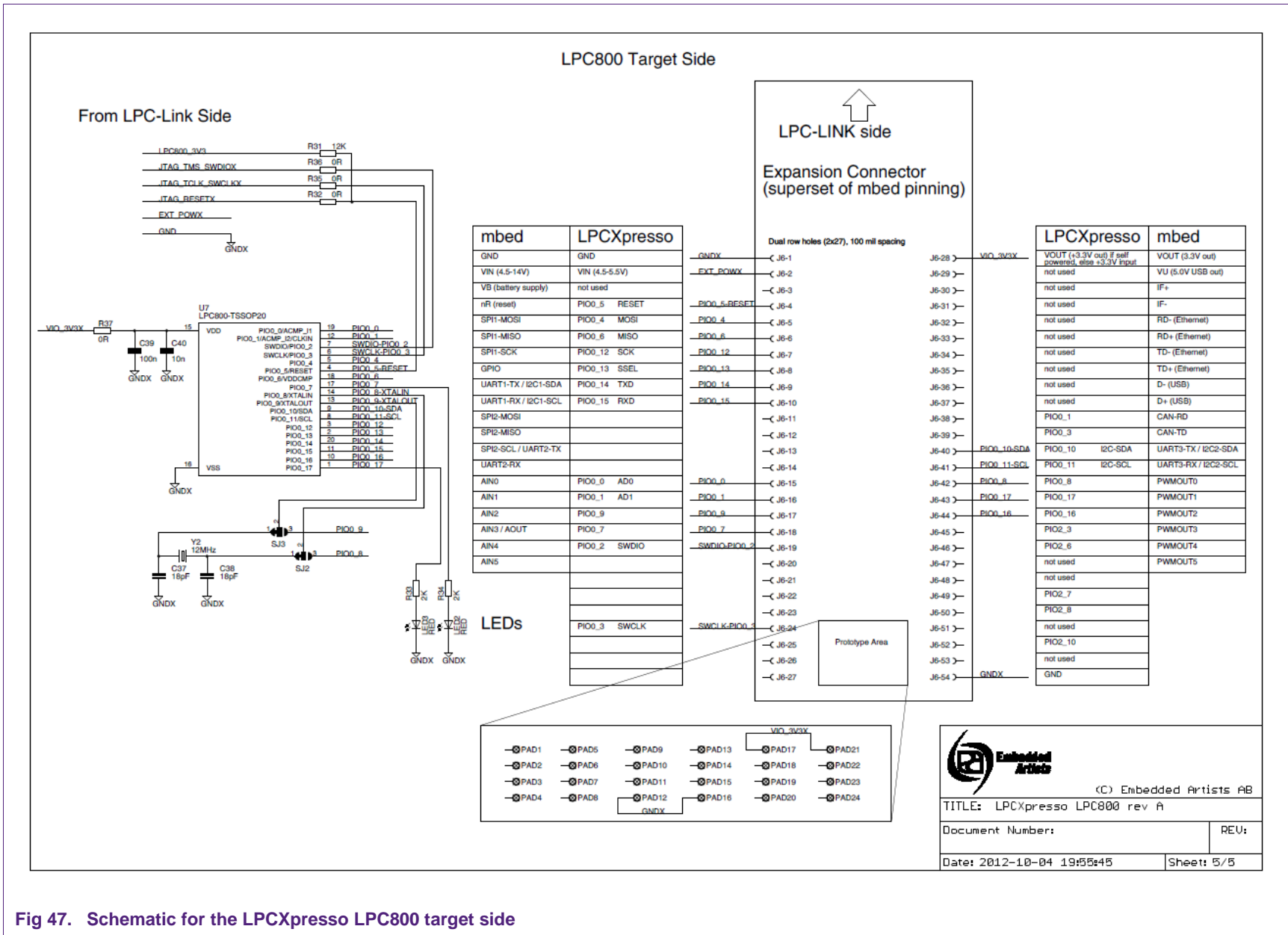

Fig 47. Schematic for the LPCXpresso LPC800 target side

Embedded Artists

© Embedded Artists AB

TITLE: LPCXpresso LPC800 rev A

Document Number: _____ REV: _____

Date: 2012-10-04 19:55:45 Sheet: 5/5

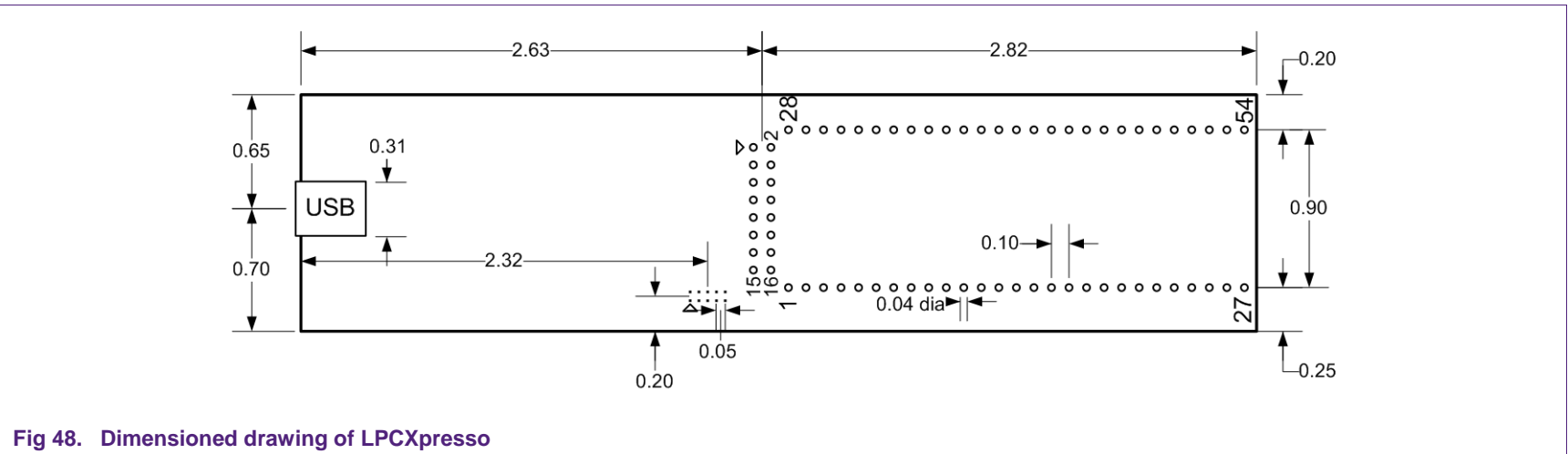

Fig 48. Dimensioned drawing of LPCXpresso

7.2 LPCXpresso PCB pinout and dimensions

The schematics of the LPCXpresso Target and the LPC-LINK debug connector appear in [Fig 34](#) to [Fig 47](#). The LPCXpresso board was designed to be pin compatible with NXP mbed. LPCXpresso can be powered either through the debug mini-USB port, by 3.3 V applied to the board, or by 5 V applied to the USB connector. A cable for the 10-pin mini JTAG connector on the LPC-LINK debugger portion of LPCXpresso can be purchased from Digi-Key, part number FFSD-05-D-06.00-01-N.

Dimensions: A dimensioned drawing of LPCXpresso can be found in [Fig 48](#). The outer dimensions of LPCXpresso are 1.35x5.45 inches. It contains two rows of holes 900 mil apart. Each row has 27 connections and holes are drilled at a 100 mil pitch.

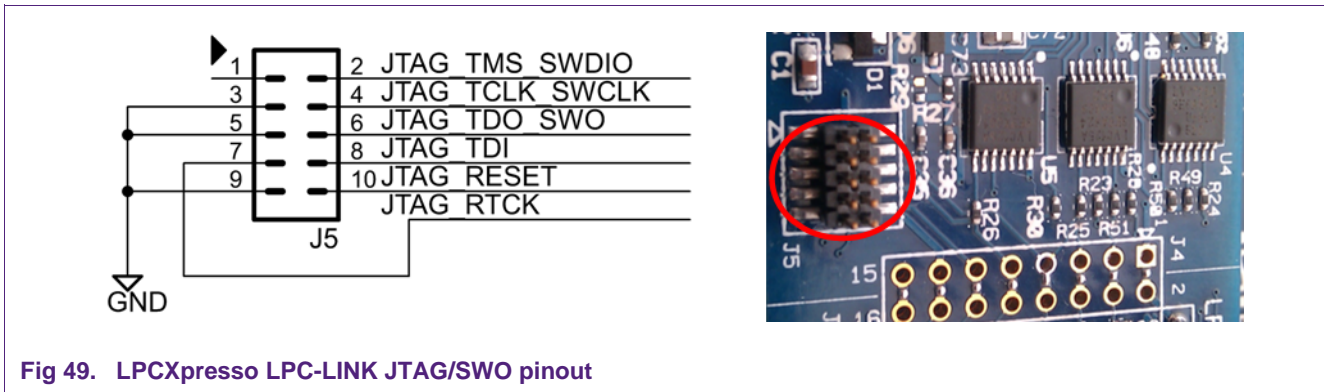

Fig 49. LPCXpresso LPC-LINK JTAG/SWO pinout

7.3 Terminology

LPCXpresso

The Code Red Technologies IDE (Integrated Development Environment) based on Eclipse with our own extensions for embedded development.

SWD

Serial Wire Debugging (Single Wire Debugging). This is a debug connection technology available on the Cortex-M3 that allows debug through just 2-wires unlike 5 for JTAG.

ELF (Executable and Linking Format)

This is the object code file format used by our development tool chain and most microprocessor tool chains.

Workspace

LPCXpresso organizes groups of projects into a 'Workspace'. A workspace is stored as a directory on your host PC and has subdirectories containing individual projects.

Project

An LPCXpresso project. A project contains all of the .c and .h files to build a single microcontroller flash image.

Perspective

In LPCXpresso, a perspective is a particular collection of 'Views' that are grouped together to be suitable for a particular use. For example the 'C/C++ programming' perspective and the 'Debug' perspective.

View

A 'View' is a window in LPCXpresso that shows a particular file or activity. A view could be of a C source code file or something live such as a disassembly window or register dump. A 'Perspective' is the layout of many 'Views'.

Semi-hosting

The ability to use IO on your debugger host system for your target embedded system. For example a 'printf' will appear in the console window of the debugger.

Debug Target

The system being debugged. LPCXpresso includes a target microcontroller on-board, but can also be connected to external targets.

Redlib™

The optimized Code Red Technologies C runtime library (non-GNU). LPCXpresso includes both Redlib and Newlib libraries.

8. References

- [1] NXP LPCXpresso <http://www.nxp.com/lpcxpresso>
- [2] NXP LPCZone <http://www.nxp.com/lpczone>
- [3] NXP Microcontrollers <http://www.nxp.com/microcontrollers>
- [4] Code Red Technologies Wiki <http://lpcxpresso.code-red-tech.com/LPCXpresso/softwareknowledgebase>
- [5] Code Red Technologies LPCXpresso page <http://lpcxpresso.code-red-tech.com>
- [6] Embedded Artists AB <http://www.embeddedartists.com>
- [7] Harbison, S.P. & Steele, G.L. (2002). *C: A Reference Manual (5th Edition)*. Prentice Hall.
- [8] Yiu, J. (2007). *The Definitive Guide to the ARM Cortex-M3*. Oxford, UK: Newnes.
- [9] Yiu, J. (2011). *The Definitive Guide to the ARM Cortex-M0*. Oxford, UK: Newnes.
- [10] ARM Cortex-M3 Technical Reference Manual. Revision: r2p0. (ARM DDI 0337G). <http://infocenter.arm.com/help/index.jsp>
- [11] ARM Cortex-M0 Technical Reference Manual. Revision: r1p0. (ARM DDI 0413D). <http://infocenter.arm.com/help/index.jsp>
- [12] ARMv7-M Architecture Reference Manual (ARM DDI 0403) <http://infocenter.arm.com/help/index.jsp>
- [13] ARMv6-M Architecture Reference Manual (Cortex-M0/LPC11) <http://infocenter.arm.com/help/index.jsp>

9. Legal information

9.1 Definitions

Draft — The document is a draft version only. The content is still under internal review and subject to formal approval, which may result in modifications or additions. NXP Semiconductors does not give any representations or warranties as to the accuracy or completeness of information included herein and shall have no liability for the consequences of use of such information.

9.2 Disclaimers

Limited warranty and liability — Information in this document is believed to be accurate and reliable. However, NXP Semiconductors does not give any representations or warranties, expressed or implied, as to the accuracy or completeness of such information and shall have no liability for the consequences of use of such information. NXP Semiconductors takes no responsibility for the content in this document if provided by an information source outside of NXP Semiconductors.

In no event shall NXP Semiconductors be liable for any indirect, incidental, punitive, special or consequential damages (including - without limitation - lost profits, lost savings, business interruption, costs related to the removal or replacement of any products or rework charges) whether or not such damages are based on tort (including negligence), warranty, breach of contract or any other legal theory.

Notwithstanding any damages that customer might incur for any reason whatsoever, NXP Semiconductors' aggregate and cumulative liability towards customer for the products described herein shall be limited in accordance with the Terms and conditions of commercial sale of NXP Semiconductors.

Right to make changes — NXP Semiconductors reserves the right to make changes to information published in this document, including without limitation specifications and product descriptions, at any time and without notice. This document supersedes and replaces all information supplied prior to the publication hereof.

Suitability for use — NXP Semiconductors products are not designed, authorized or warranted to be suitable for use in life support, life-critical or safety-critical systems or equipment, nor in applications where failure or malfunction of an NXP Semiconductors product can reasonably be expected to result in personal injury, death or severe property or environmental damage. NXP Semiconductors and its suppliers accept no liability for inclusion and/or use of NXP Semiconductors products in such equipment or applications and therefore such inclusion and/or use is at the customer's own risk.

Applications — Applications that are described herein for any of these products are for illustrative purposes only. NXP Semiconductors makes no representation or warranty that such applications will be suitable for the specified use without further testing or modification.

Customers are responsible for the design and operation of their applications and products using NXP Semiconductors products, and NXP Semiconductors accepts no liability for any assistance with applications or customer product design. It is customer's sole responsibility to determine whether the NXP Semiconductors product is suitable and fit for the customer's applications and products planned, as well as for the planned application and use of customer's third party customer(s). Customers should provide appropriate design and operating safeguards to minimize the risks associated with their applications and products.

NXP Semiconductors does not accept any liability related to any default, damage, costs or problem which is based on any weakness or default in the customer's applications or products, or the application or use by customer's third party customer(s). Customer is responsible for doing all necessary testing for the customer's applications and products using NXP Semiconductors products in order to avoid a default of the applications and the products or of the application or use by customer's third party customer(s). NXP does not accept any liability in this respect.

Export control — This document as well as the item(s) described herein may be subject to export control regulations. Export might require a prior authorization from competent authorities.

Evaluation products — This product is provided on an "as is" and "with all faults" basis for evaluation purposes only. NXP Semiconductors, its affiliates and their suppliers expressly disclaim all warranties, whether express, implied or statutory, including but not limited to the implied warranties of non-infringement, merchantability and fitness for a particular purpose. The entire risk as to the quality, or arising out of the use or performance, of this product remains with customer.

In no event shall NXP Semiconductors, its affiliates or their suppliers be liable to customer for any special, indirect, consequential, punitive or incidental damages (including without limitation damages for loss of business, business interruption, loss of use, loss of data or information, and the like) arising out of the use of or inability to use the product, whether or not based on tort (including negligence), strict liability, breach of contract, breach of warranty or any other theory, even if advised of the possibility of such damages.

Notwithstanding any damages that customer might incur for any reason whatsoever (including without limitation, all damages referenced above and all direct or general damages), the entire liability of NXP Semiconductors, its affiliates and their suppliers and customer's exclusive remedy for all of the foregoing shall be limited to actual damages incurred by customer based on reasonable reliance up to the greater of the amount actually paid by customer for the product or five dollars (US\$5.00). The foregoing limitations, exclusions and disclaimers shall apply to the maximum extent permitted by applicable law, even if any remedy fails of its essential purpose.

9.3 Trademarks

Notice: All referenced brands, product names, service names and trademarks are property of their respective owners.

10. Contents

1.	Introduction	3	9.	Legal information	48
1.1	LPCXpresso 5 new features.....	4	9.1	Definitions.....	48
1.2	LPCXpresso IDE	4	9.2	Disclaimers.....	48
1.3	LPCXpresso development board	5	9.3	Trademarks	48
1.4	LPC-LINK JTAG/SWD debugger	6	10.	Contents	49
1.5	Integrated evaluation target.....	6			
1.6	LPCXpresso partners	6			
2.	Evaluate, explore and develop	7			
3.	Installation	8			
3.1	System requirements	8			
3.2	Installation process	8			
3.3	Activation.....	10			
4.	Getting familiar with the LPCXpresso IDE	11			
4.1	Layout of the LPCXpresso desktop	11			
4.1.1	Single perspective (code development)	12			
4.1.2	Single perspective (debug).....	13			
4.2	Connecting the target.....	15			
5.	Working with example projects.....	16			
5.1	Downloading NXP sample code from the web .	16			
5.2	Debugging/running 'blinky' or another project on your LPCXpresso board.....	19			
5.3	Working with Instruction Trace	20			
6.	LPCXpresso IDE tips and tricks	20			
6.1	Installing Eclipse plugins	20			
6.2	Debugging tips	20			
6.2.1	Debug features not enabled	20			
6.2.2	Error launching debug\filename.axf.....	21			
6.2.3	Optimization issues	22			
6.2.4	Exiting debug mode and stopping debugging ..	22			
6.2.5	Recovery of board.....	22			
6.3	Datasheet browser	23			
6.4	Code size	23			
6.4.1	printf	23			
6.4.2	Optimization	24			
6.5	Showing hidden views.....	24			
6.6	Creating a 'skeleton' project in a new Workspace	24			
6.6.1	Create a new Workspace.....	25			
6.6.2	Create the 'Skeleton' project	25			
7.	Appendix	29			
7.1	LPCXpresso target side schematics	29			
7.2	LPCXpresso PCB pinout and dimensions	45			
7.3	Terminology	46			
8.	References	47			

Please be aware that important notices concerning this document and the product(s) described herein have been included in the section 'Legal information'.
