

RSAN SERIES

高電圧パルス対応の汎用单相フィルタ

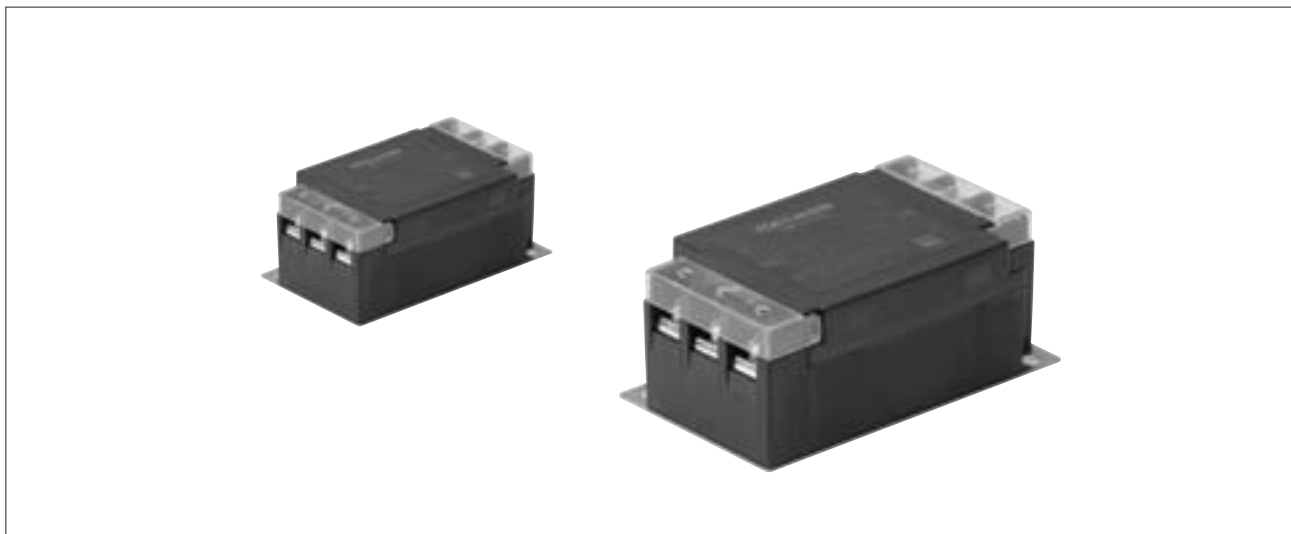

■ 特 長

- RSEN シリーズの共通モードコイル磁芯にアモルファスコアを採用しており、機器の誤動作防止に効果があります。
- セルフアップねじ、開閉式カバーにより配線作業性が向上
- オプションとして低漏洩電流特性タイプ、DIN レール取付対応タイプをラインアップ
- RoHS 指令対応製品です。

■ 取得安全規格

UL1283	File No. E62388
CSA C22.2 No.8	File No. 208777
EN60939	Licence Ref. No. SE/07115-2

■ 品名呼称法

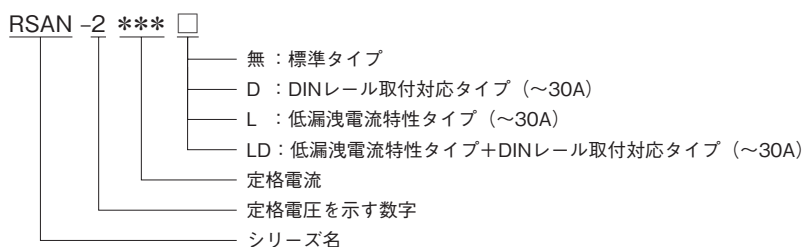

■ 回路図

RSAN-2 ***
RSAN-2 *** D

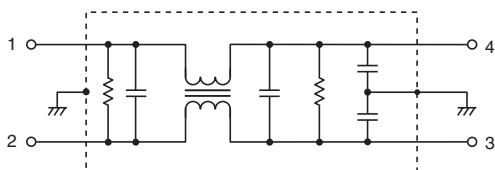

RSAN-2 *** L

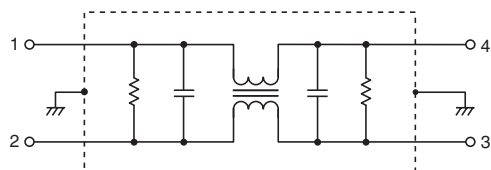

●RoHS 指令対応 : EU Directive 2002/95/EC にもとづき、免除された用途を除いて、鉛、カドミウム、水銀、六価クロム、および特定臭素系難燃剤の PBB、PBDE を使用していないことを表します。

■ 電気的特性

品名	定格電圧 (AC/DC)	定格電流 (AC/DC)	耐電圧	絶縁抵抗	漏洩電流	使用温度範囲	ディレーティング 開始温度	直流抵抗 (mΩ)	減衰量保証帯域(MHz)		質量 (g)
									コモンモード	ディファレンシャルモード	
									25dB保証	25dB保証	
RSAN-2003	250V	3A	AC.2500V 60s [ラインアース間]	100MΩ min. [DC.500V/ 1min]	1.0mA max. [250V/60Hz]	-25~+85℃	55℃	250 max.	0.1~10	0.1~30	170
RSAN-2006		6A						110 max.	0.1~10	0.1~30	230
RSAN-2010		10A						40 max.	0.3~10	0.2~30	230
RSAN-2016		16A						20 max.	0.8~10	0.3~30	230
RSAN-2020		20A						10 max.	1~10	0.3~30	230
RSAN-2030		30A						6 max.	2~10	0.4~30	230
RSAN-2040		40A						6 max.	0.8~10	0.1~30	870
RSAN-2050		50A						4 max.	1~10	0.1~30	870
RSAN-2060		60A						3 max.	2~10	0.2~30	870

品名	定格電圧 (AC/DC)	定格電流 (AC/DC)	耐電圧	絶縁抵抗	漏洩電流	使用温度範囲	ディレーティング 開始温度	直流抵抗 (mΩ)	減衰量保証帯域(MHz)			質量 (g)
									コモンモード		ディファレンシャルモード	
									20dB保証	10dB保証	25dB保証	
RSAN-2003L	250V	3A	AC.2500V 60s [ラインアース間]	100MΩ min. [DC.500V/ 1min]	10μA max. [250V/60Hz]	-25~+85℃	55℃	250 max.	0.1~3	-	0.1~30	170
RSAN-2006L		6A						110 max.	0.1~3	-	0.1~30	230
RSAN-2010L		10A						40 max.	0.5~6	-	0.2~30	230
RSAN-2016L		16A						20 max.	-	0.3~10	0.3~30	230
RSAN-2020L		20A						10 max.	-	0.5~8	0.3~30	230
RSAN-2030L		30A						6 max.	-	3~20	0.4~30	230

■ ディレーティングカーブ

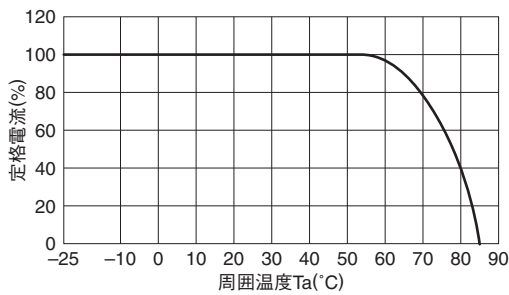

■ 外観図

RSAN-2003/2006/2010/2016/2020/2030

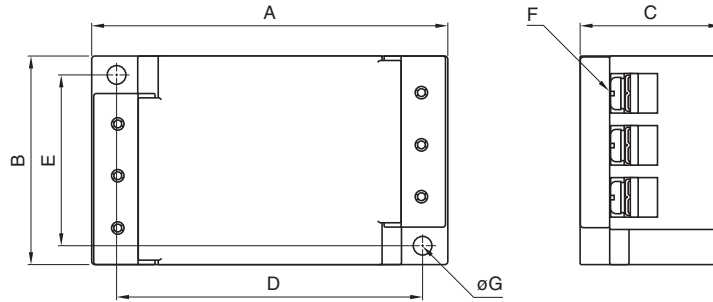

RSAN-2040/2050/2060

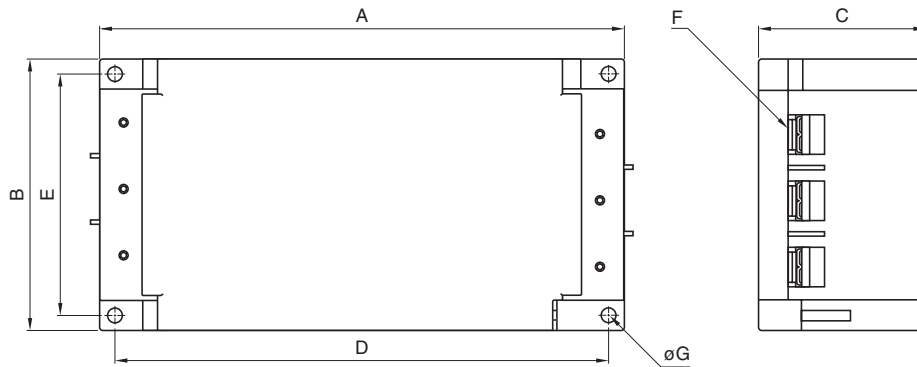

単位：mm

品名	A	B	C	D	E	F	φG	推奨締め付けトルク
RSAN-2003	87	52	35	75	43	M4	4.5	1.27N・m
RSAN-2006								
RSAN-2010								
RSAN-2016								
RSAN-2020								
RSAN-2030								
RSAN-2040	170	90	54	160	80	M5	4.5	2.5N・m
RSAN-2050								
RSAN-2060								

RSAN-2003D/2006D/2010D/2016D/2020D/2030D

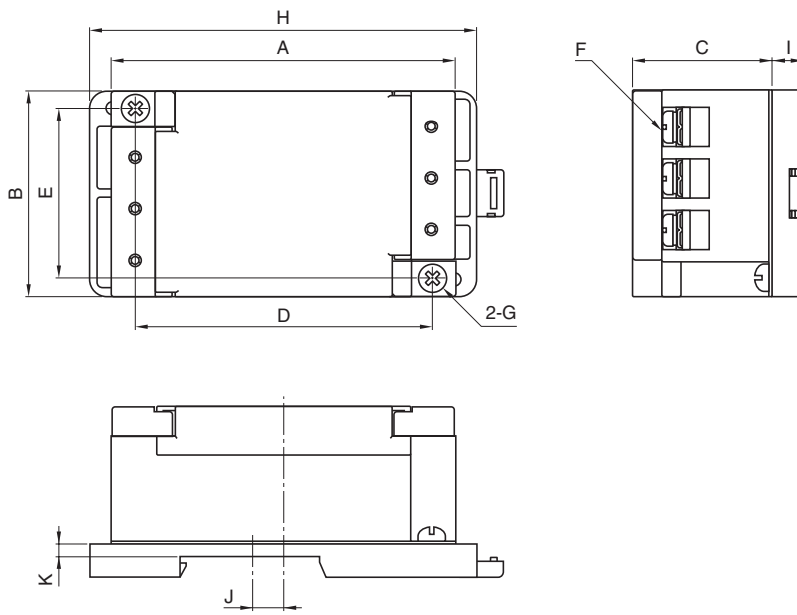

単位：mm

品名	A	B	C	D	E	F	G	H	I	J	K
RSAN-2003D	87	52	35	75	43	M4	M4	98	8.4	8.5	3.5
RSAN-2006D											
RSAN-2010D											
RSAN-2016D											
RSAN-2020D											
RSAN-2030D											

■ 減衰量周波数特性

RSAN-2003

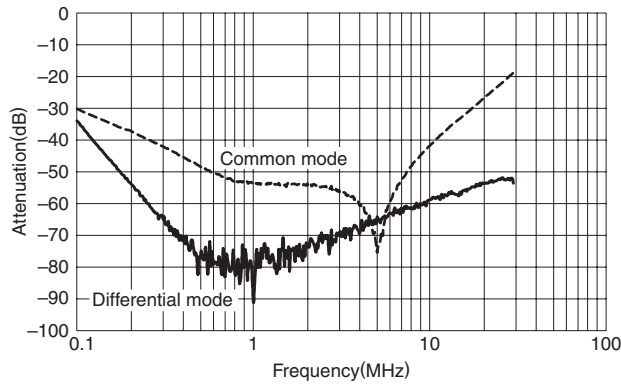

RSAN-2006

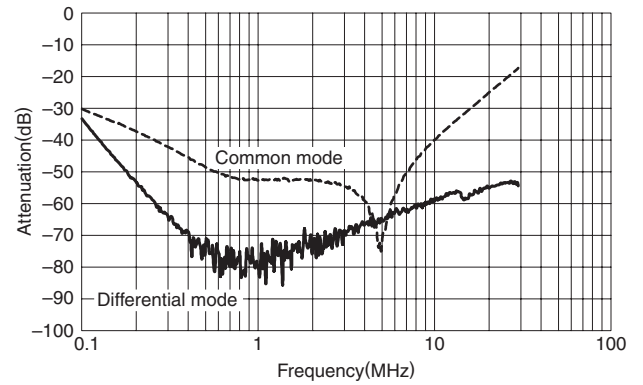

RSAN-2010

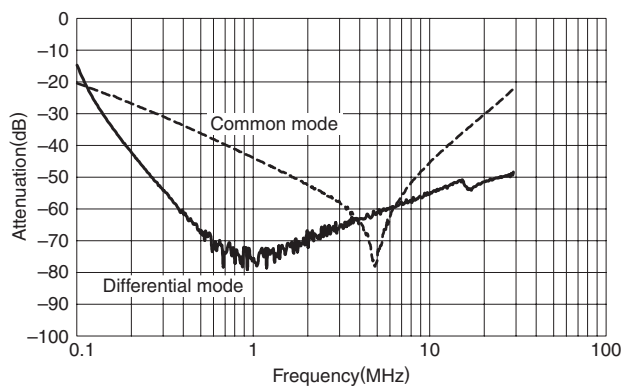

RSAN-2016

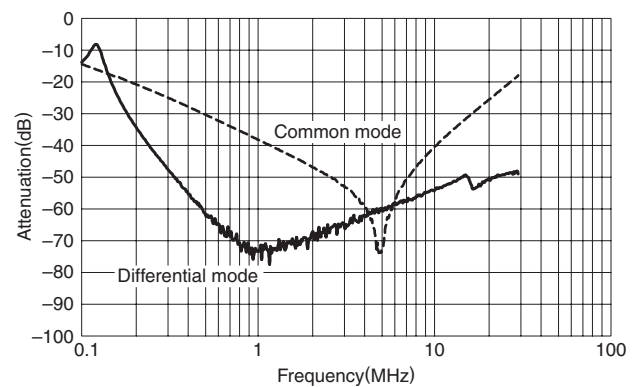

RSAN-2020

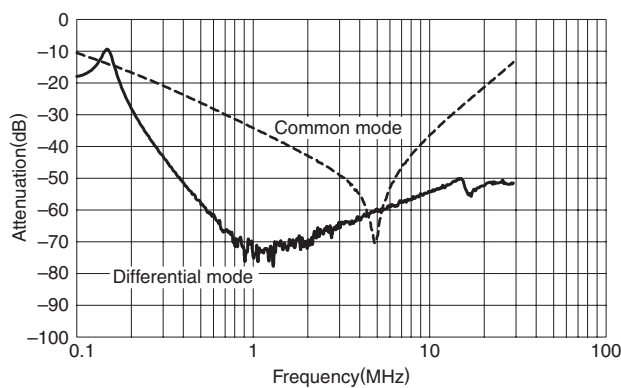

RSAN-2030

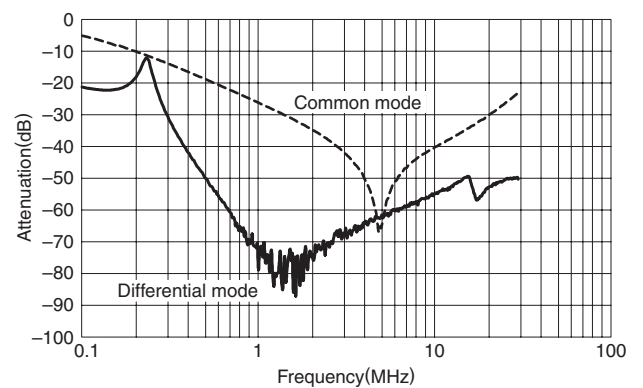

RSAN-2040

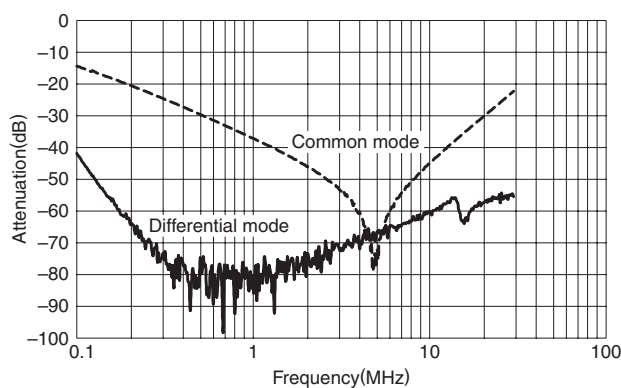

RSAN-2050

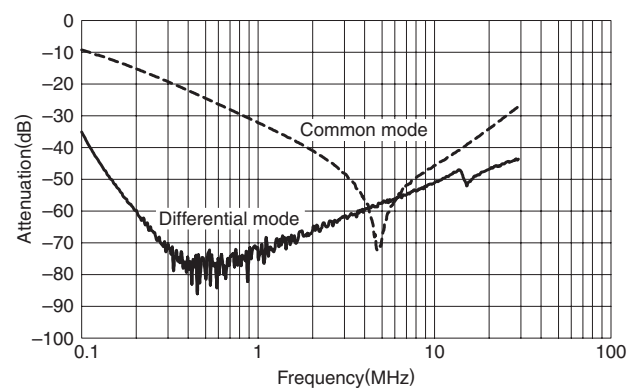

RSAN-2060

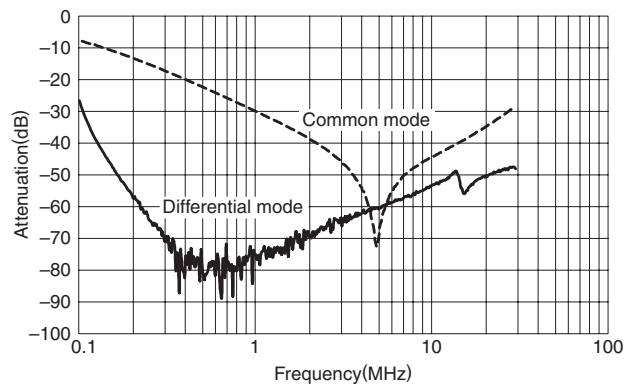

RSAN-2003L

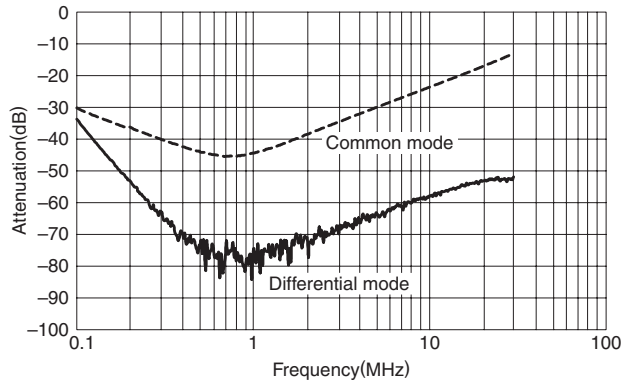

RSAN-2006L

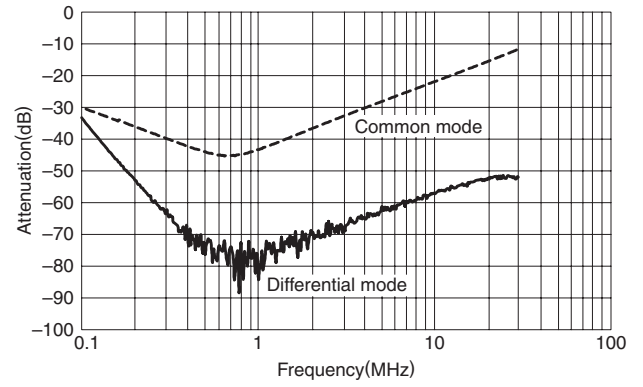

RSAN-2010L

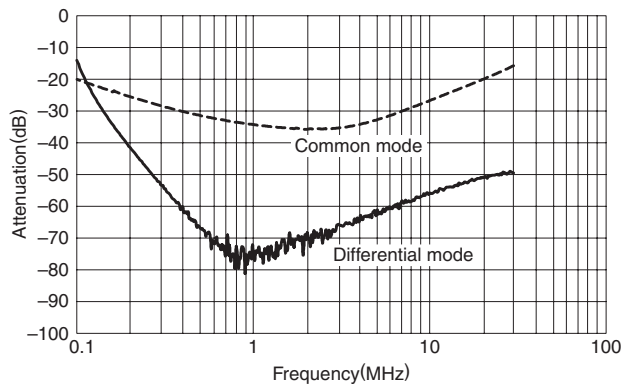

RSAN-2016L

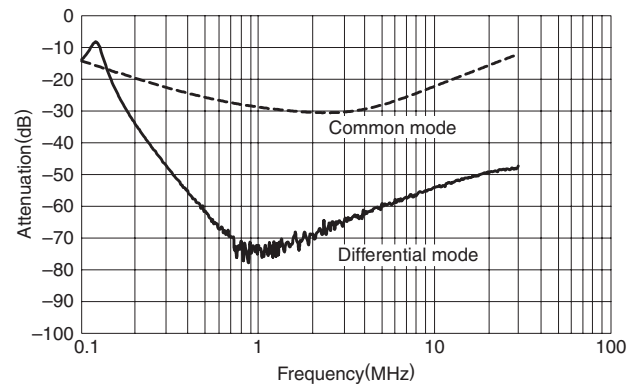

RSAN-2020L

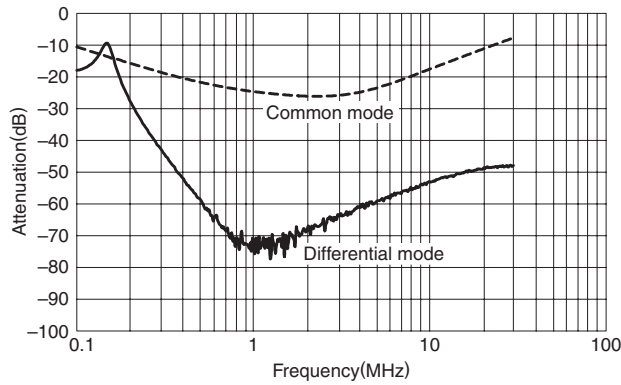

RSAN-2030L

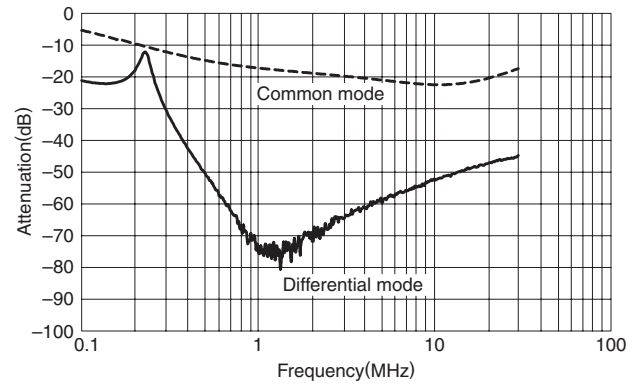

■ パルス減衰特性

RSAN-2003/2003D

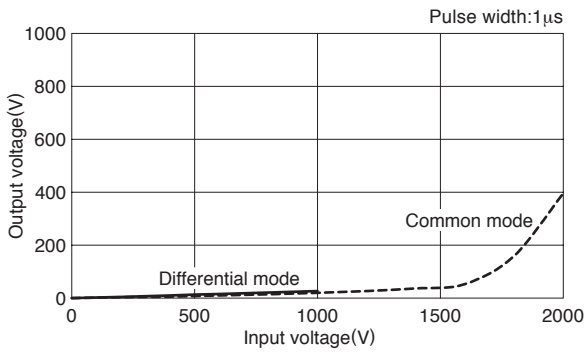

RSAN-2006/2006D

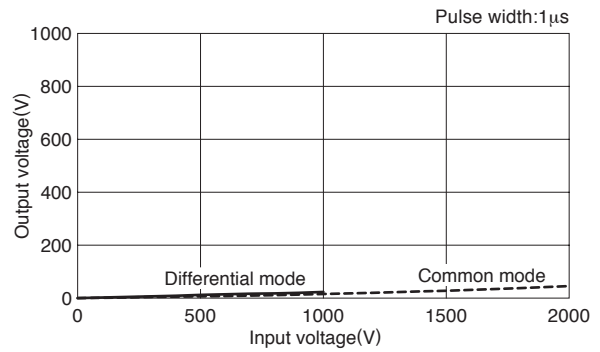

RSAN-2010/2010D

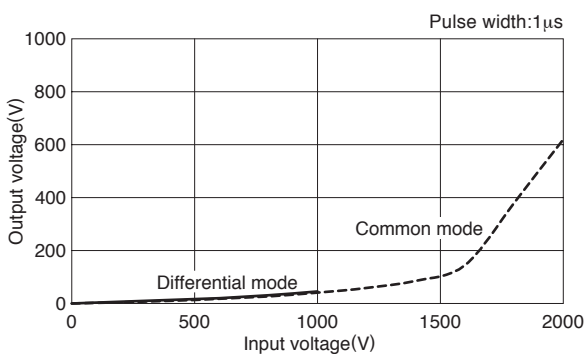

RSAN-2016/2016D

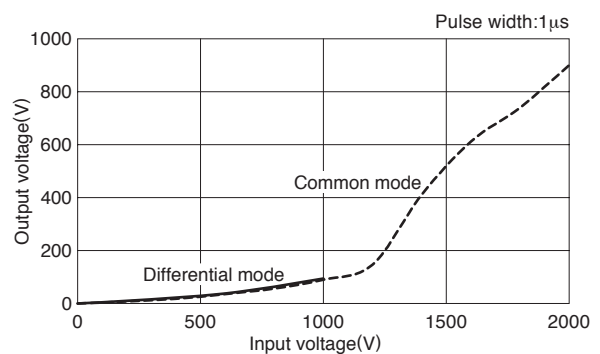

RSAN-2020/2020D

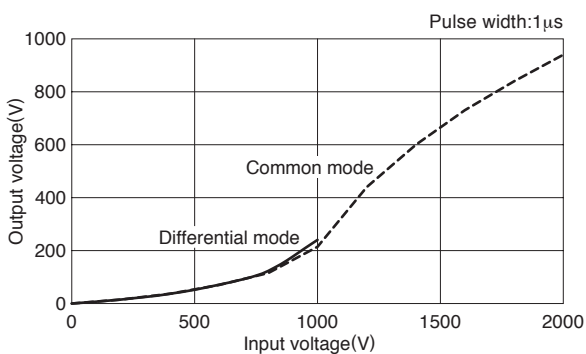

RSAN-2030/2030D

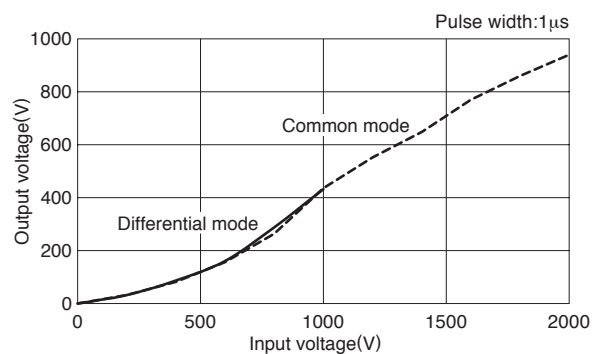

RSAN-2040

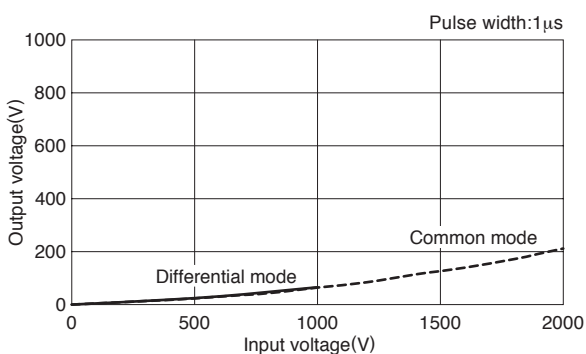

RSAN-2050

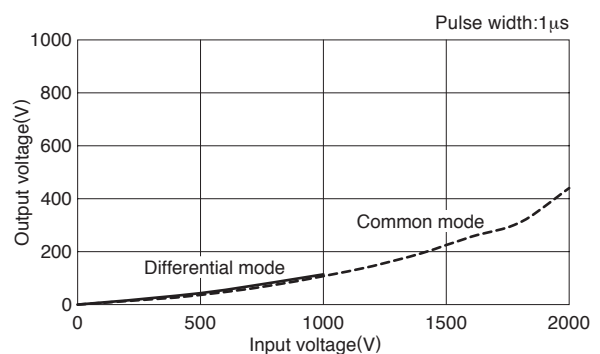

RSAN-2060

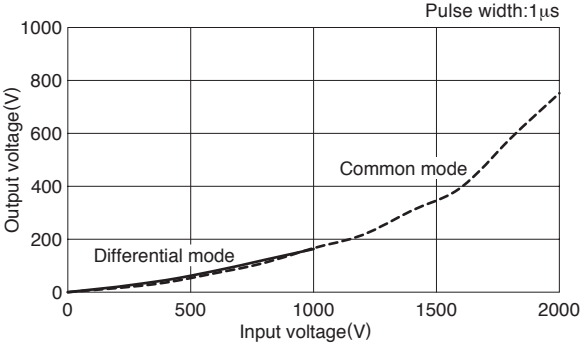

RSAN-2003L/LD

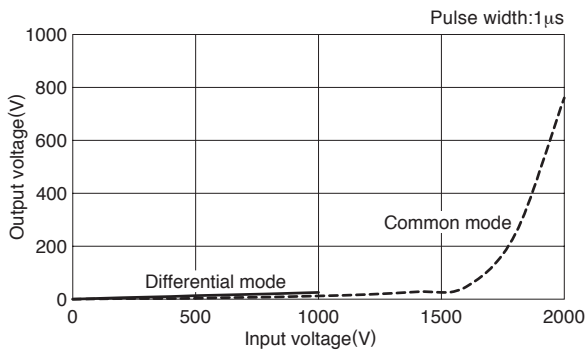

RSAN-2006L/LD

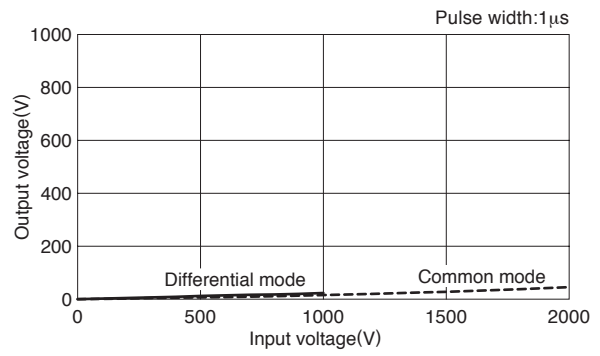

RSAN-2010L/LD

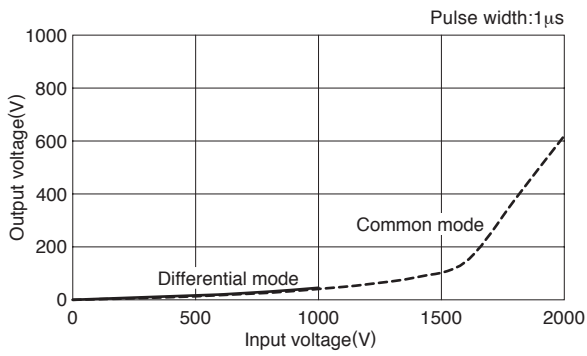

RSAN-2016L/LD

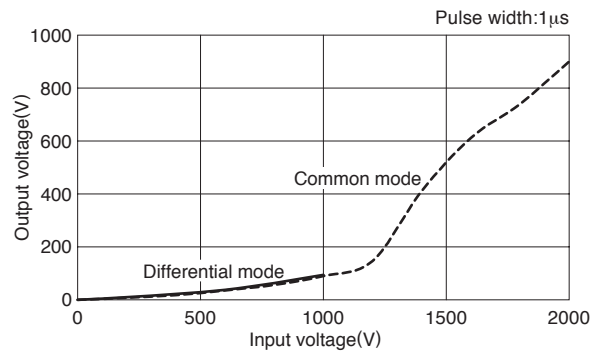

RSAN-2020L/LD

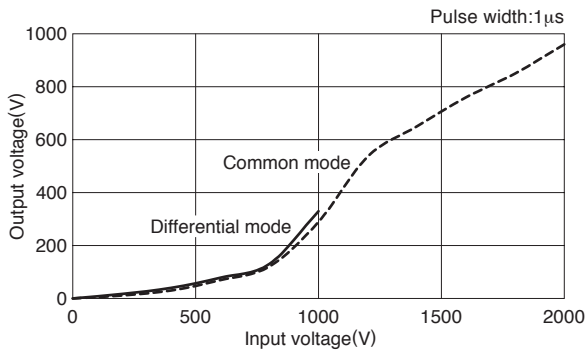

RSAN-2030L/LD

