

# Device Modeling Report

COMPONENTS: ZNR Transient/Surge Absorber  
PART NUMBER: ERZC20EK471  
MANUFACTURER: Panasonic



**Bee Technologies Inc.**

# Equivalent Circuit

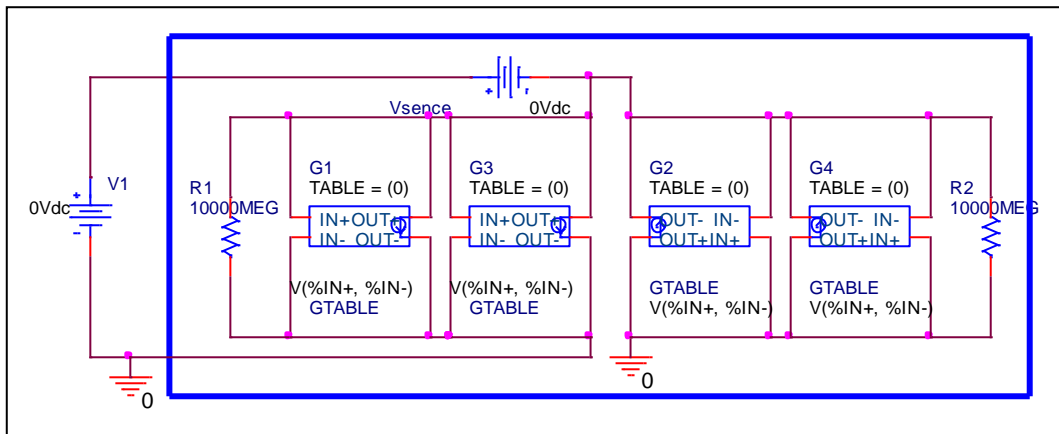

# ZNR Transient /Surge Absorber

## Circuit Simulation Result

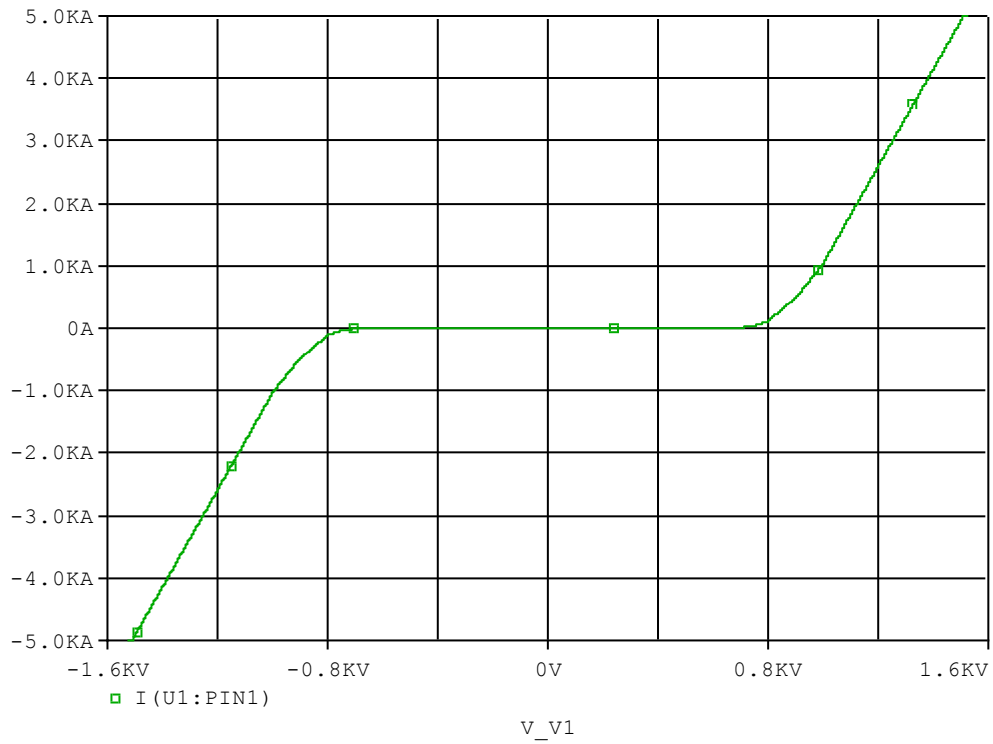

## Evaluation Circuit

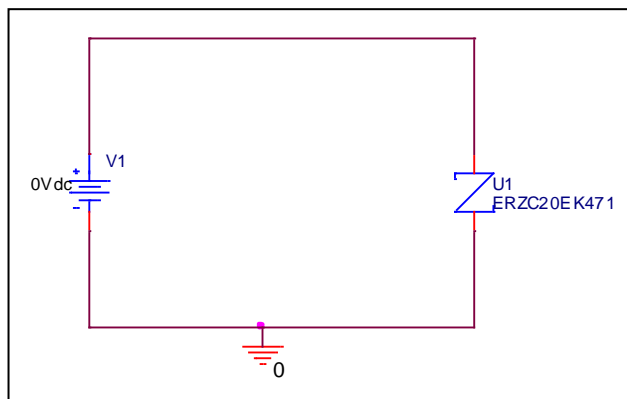

# ZNR Transient /Surge Absorber

## Comparison Graph

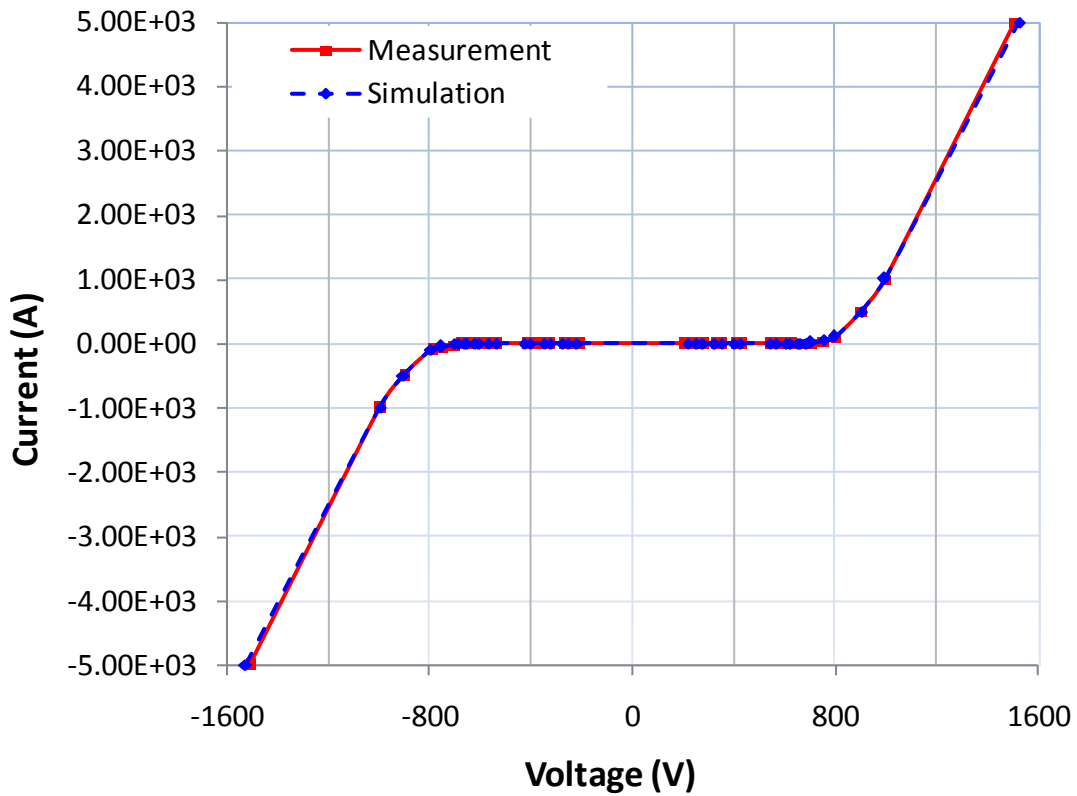

### Simulation Result

I(A)	VFwd (V)		Error (%)
	Measurement	Simulation	
1.00E-06	210.000	219.771	4.653
1.00E-05	275.000	276.214	0.441
1.00E-04	350.000	350.125	0.036
1.00E-03	425.000	425.028	0.007
1.00E-02	570.000	570.001	0.000
1.00E-01	625.000	625.000	0.000
1.00E+00	655.000	658.750	0.573
1.00E+01	703.000	703.650	0.092
1.00E+02	795.000	795.135	0.017
1.00E+03	995.000	995.100	0.010
5.00E+03	1510.000	1527.300	1.146