

Device Modeling Report

COMPONENTS: ZNR Transient/Surge Absorber
PART NUMBER: ERZC32EK102
MANUFACTURER: Panasonic



Bee Technologies Inc.

Equivalent Circuit

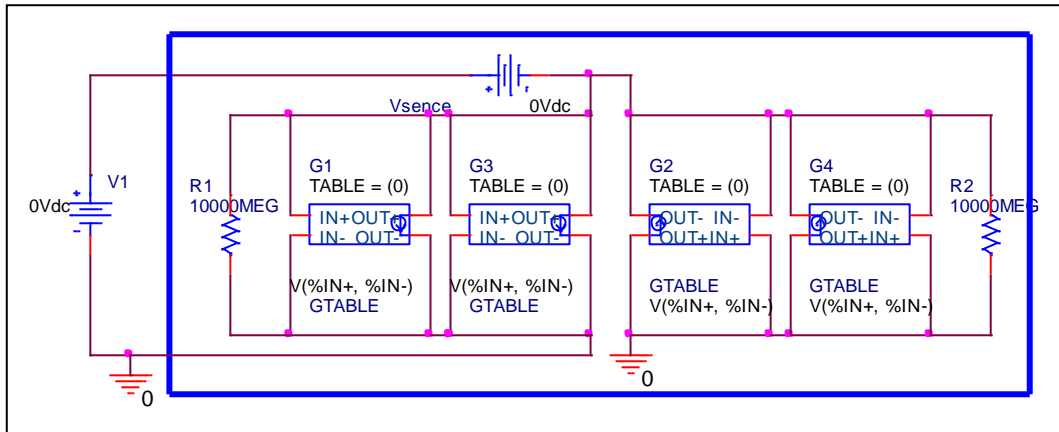

ZNR Transient /Surge Absorber

Circuit Simulation Result

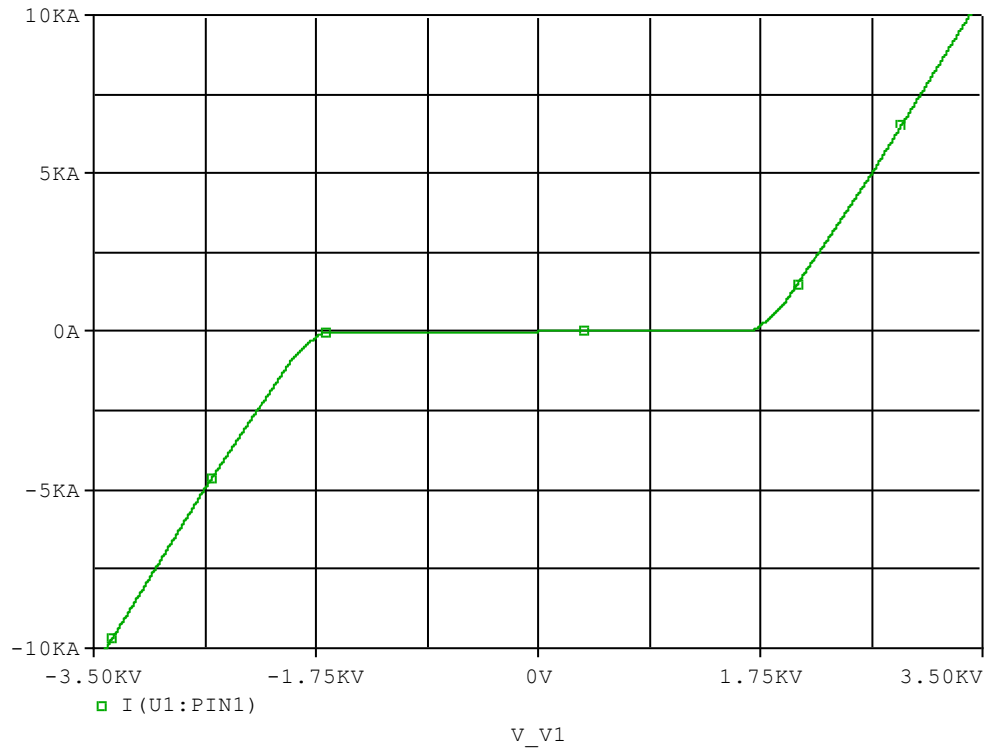

Evaluation Circuit

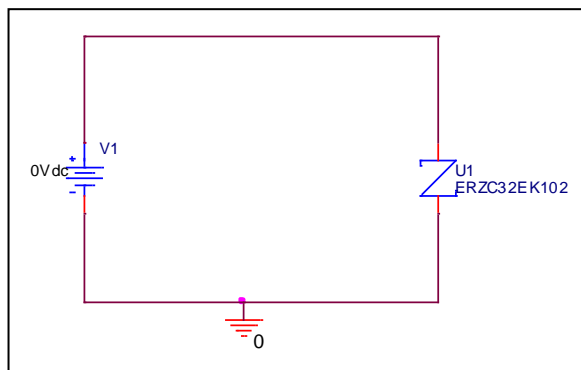

ZNR Transient /Surge Absorber

Comparison Graph

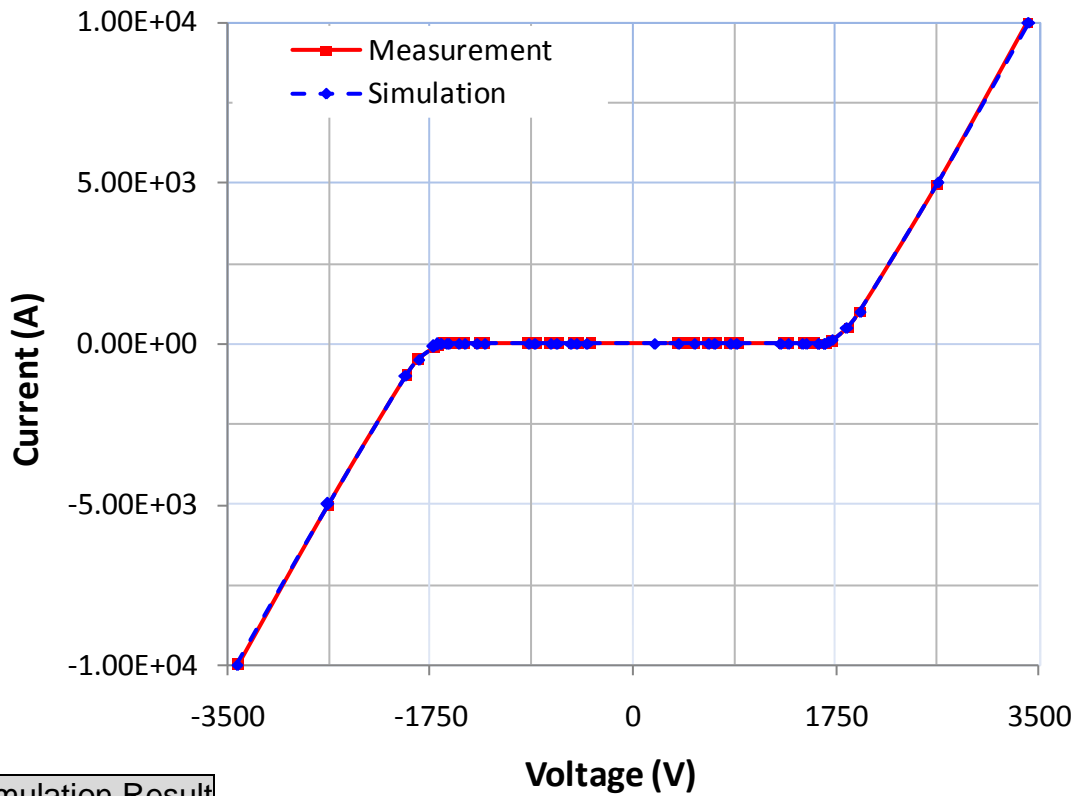

Simulation Result

I(A)	VFwd (V)		Error (%)
	Measurement	Simulation	
5.00E-06	475.000	484.496	1.999
1.00E-05	525.000	527.953	0.562
1.00E-04	710.000	710.301	0.042
1.00E-03	900.000	900.086	0.010
1.00E-02	1340.000	1340.000	0.000
1.00E-01	1500.000	1500.000	0.000
1.00E+00	1595.000	1601.900	0.433
1.00E+01	1655.000	1655.400	0.024
1.00E+02	1720.000	1720.200	0.012
1.00E+03	1960.000	1960.100	0.005
1.00E+04	3400.000	3415.000	0.441