

# Device Modeling Report

COMPONENTS: ZNR Transient/Surge Absorber  
PART NUMBER: ERZC32EK241  
MANUFACTURER: Panasonic



**Bee Technologies Inc.**

# Equivalent Circuit

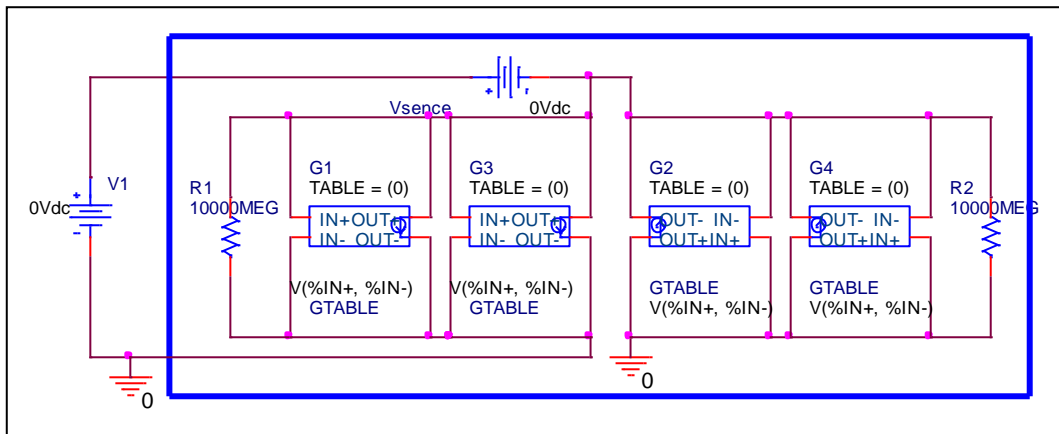

# ZNR Transient /Surge Absorber

## Circuit Simulation Result

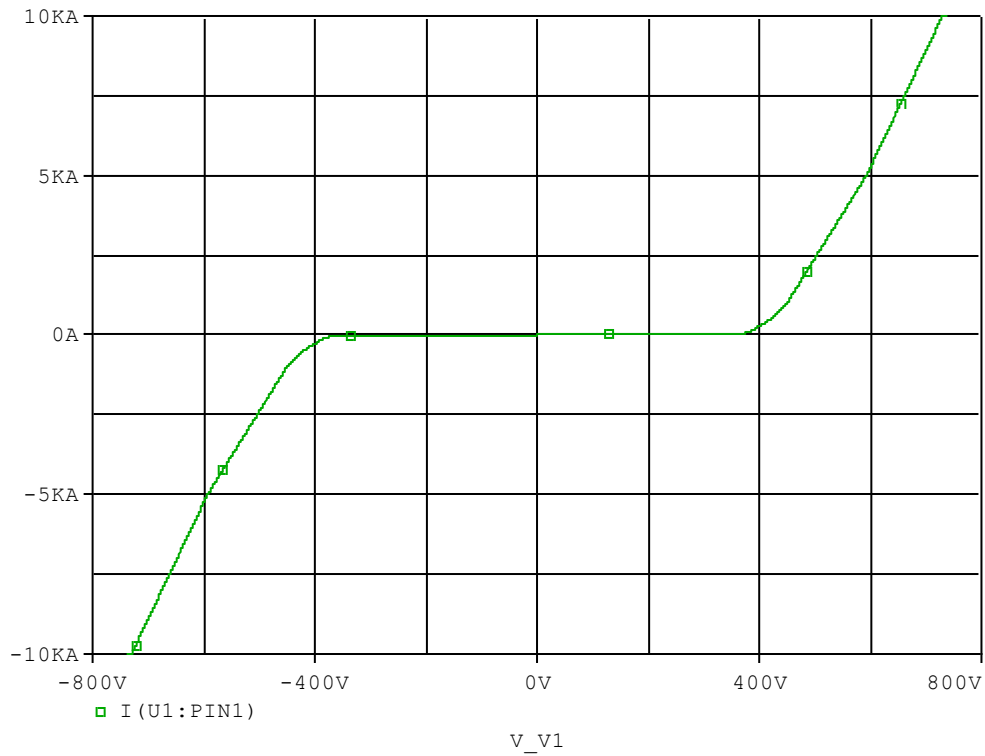

## Evaluation Circuit

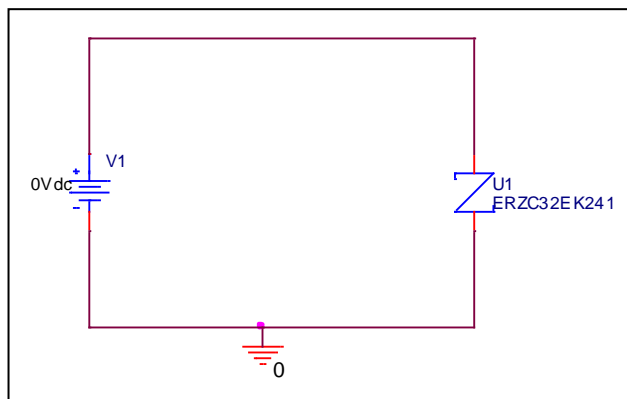

# ZNR Transient /Surge Absorber

## Comparison Graph

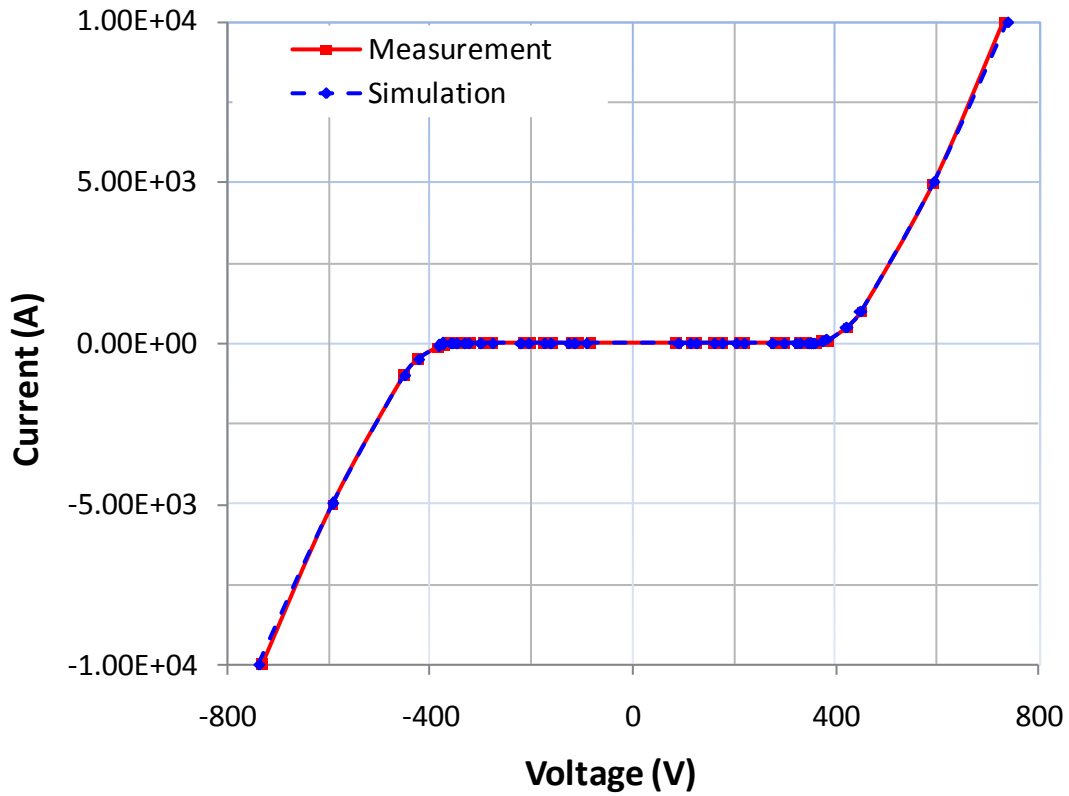

### Simulation Result

I(A)	VFwd (V)		Error (%)
	Measurement	Simulation	
5.00E-06	110.000	112.965	2.695
1.00E-05	125.000	125.864	0.691
1.00E-04	175.000	175.074	0.042
1.00E-03	220.000	220.014	0.006
1.00E-02	298.000	298.001	0.000
1.00E-01	330.000	330.000	0.000
1.00E+00	348.000	348.875	0.251
1.00E+01	359.000	359.175	0.049
1.00E+02	383.000	383.047	0.012
1.00E+03	450.000	450.018	0.004
1.00E+04	730.000	738.700	1.192