

Device Modeling Report

COMPONENTS: ZNR Transient/Surge Absorber
PART NUMBER: ERZC32EK271
MANUFACTURER: Panasonic



Bee Technologies Inc.

Equivalent Circuit

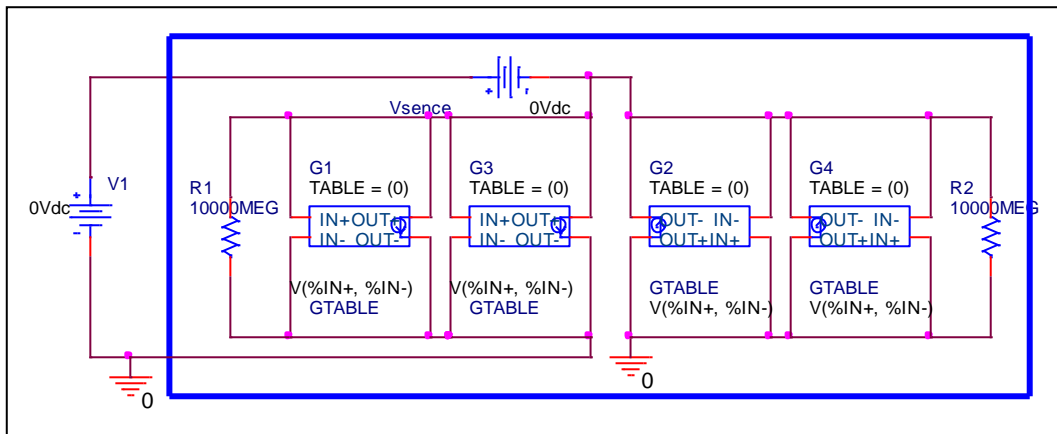

ZNR Transient /Surge Absorber

Circuit Simulation Result

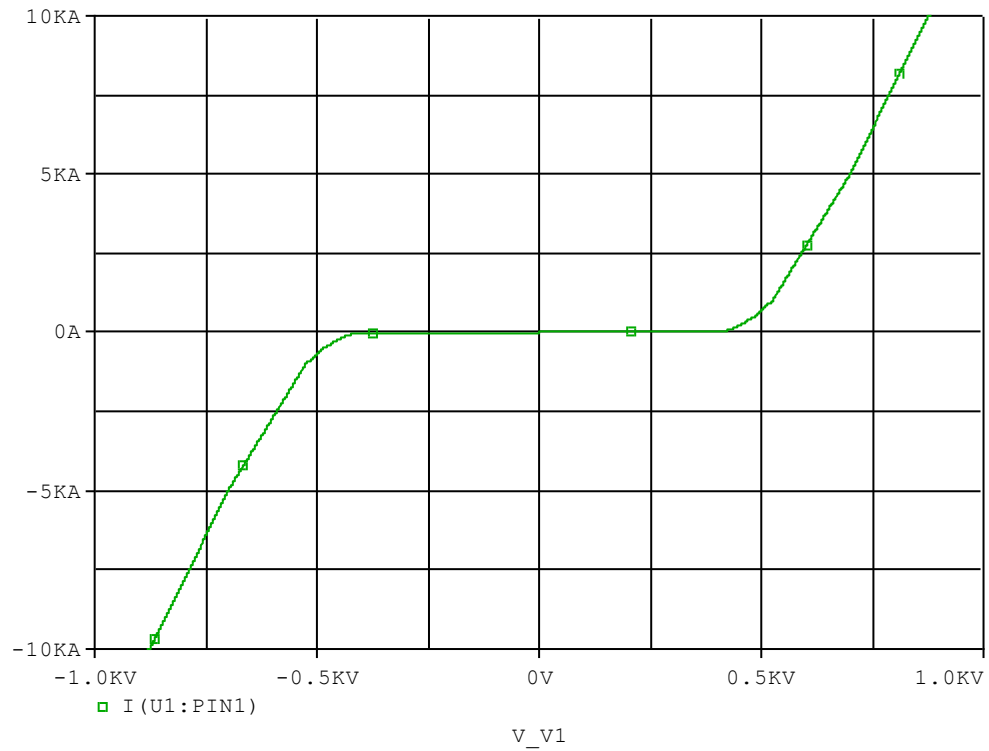

Evaluation Circuit

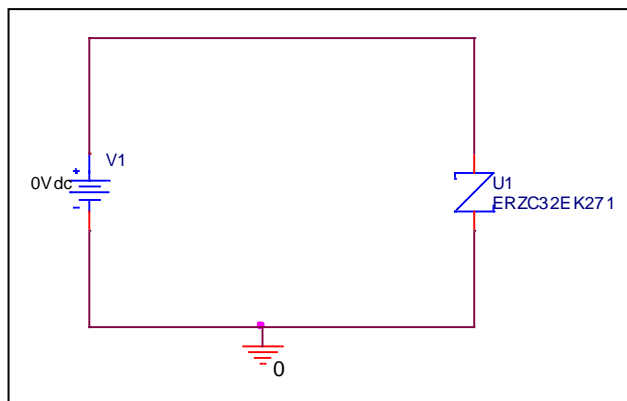

ZNR Transient /Surge Absorber

Comparison Graph

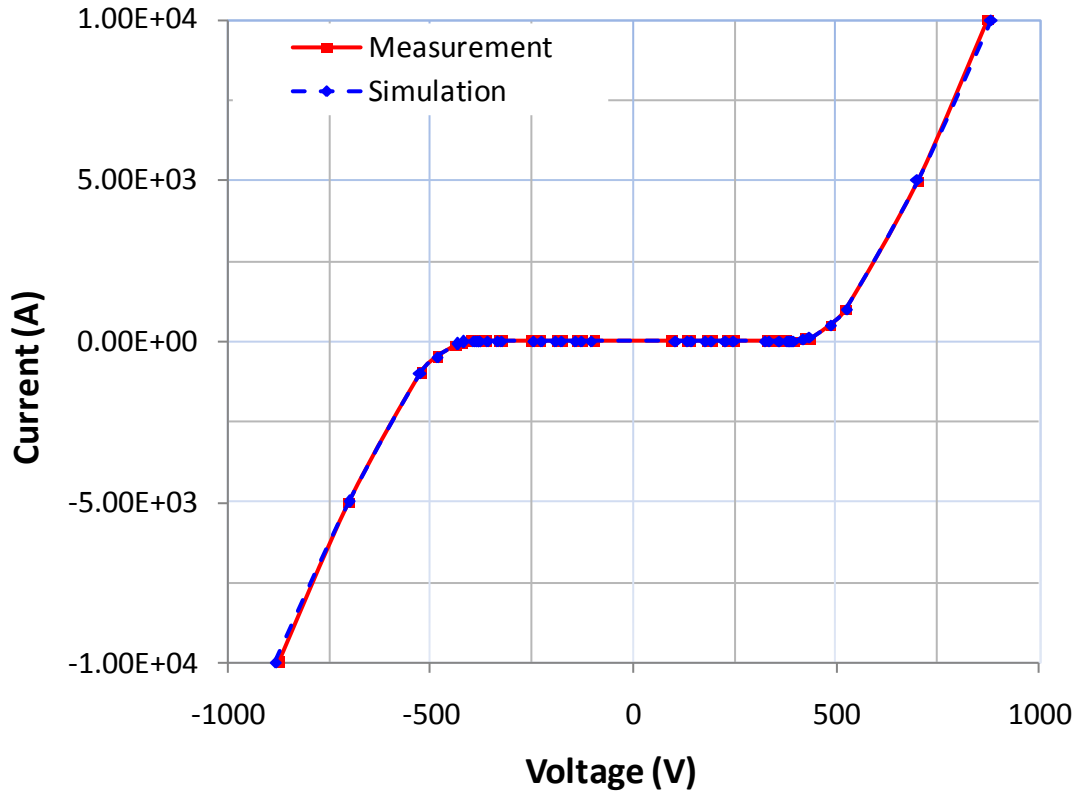

Simulation Result

I(A)	VFwd (V)		Error (%)
	Measurement	Simulation	
5.00E-06	128.000	130.762	2.158
1.00E-05	142.000	142.862	0.607
1.00E-04	192.000	192.088	0.046
1.00E-03	248.000	248.019	0.008
1.00E-02	335.000	335.001	0.000
1.00E-01	366.000	378.000	3.279
1.00E+00	383.000	383.700	0.183
1.00E+01	395.000	395.250	0.063
1.00E+02	435.000	435.050	0.011
1.00E+03	525.000	525.018	0.003
1.00E+04	875.000	882.900	0.903