

Device Modeling Report

COMPONENTS: ZNR Transient/Surge Absorber
PART NUMBER: ERZC32EK781
MANUFACTURER: Panasonic



Bee Technologies Inc.

Equivalent Circuit

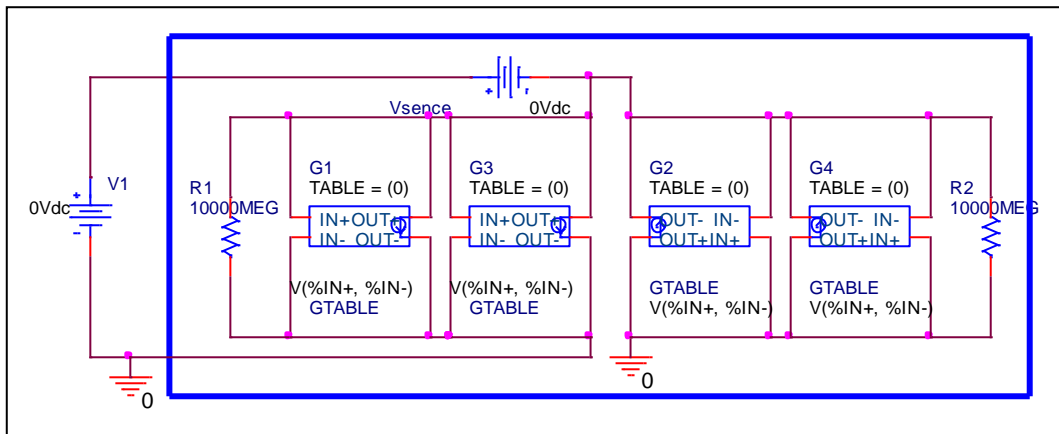

ZNR Transient /Surge Absorber

Circuit Simulation Result

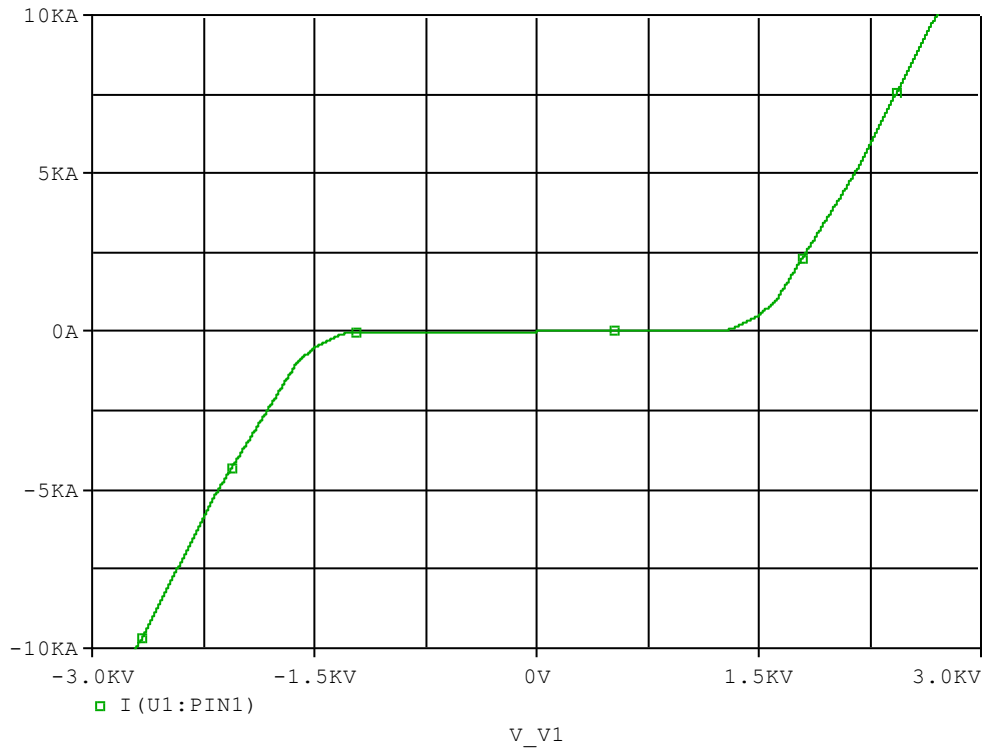

Evaluation Circuit

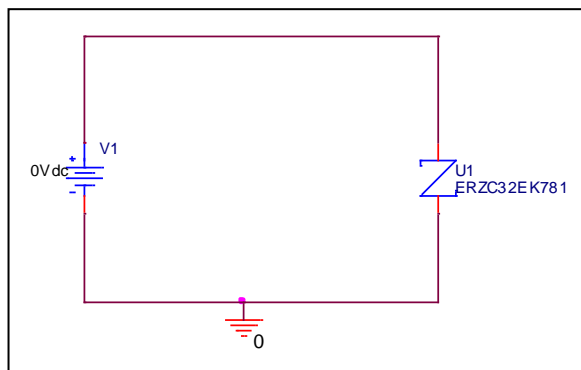

ZNR Transient /Surge Absorber

Comparison Graph

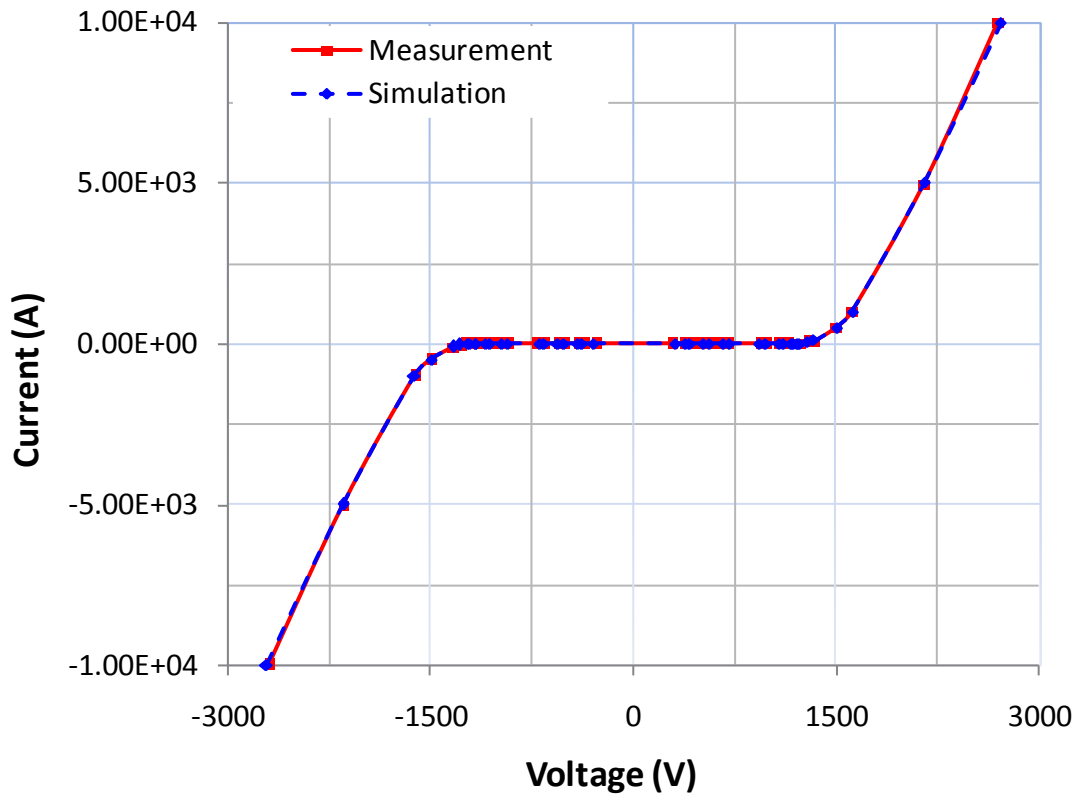

Simulation Result

I(A)	VFwd (V)		Error (%)
	Measurement	Simulation	
5.00E-06	370.000	378.646	2.337
1.00E-05	415.000	417.392	0.576
1.00E-04	560.000	560.235	0.042
1.00E-03	700.000	700.053	0.008
1.00E-02	980.000	980.002	0.000
1.00E-01	1100.000	1100.000	0.000
1.00E+00	1170.000	1175.000	0.427
1.00E+01	1230.000	1230.700	0.057
1.00E+02	1332.000	1332.200	0.015
1.00E+03	1620.000	1620.100	0.006
1.00E+04	2700.000	2716.200	0.600