

Device Modeling Report

COMPONENTS: Filament Lamp
PART NUMBER: BELLA K SIL 60
MANUFACTURER: OSRAM GmbH



Bee Technologies Inc.

Transient Current Characteristics

Circuit simulation result

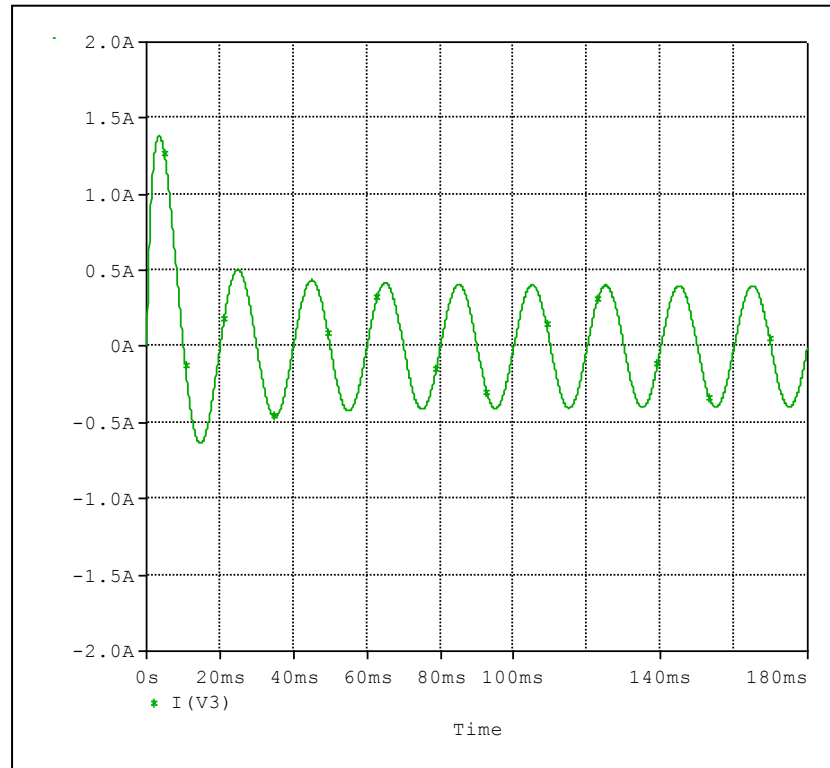

Evaluation circuit

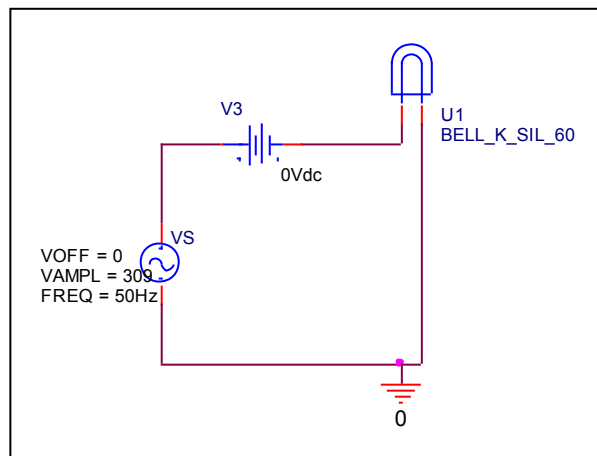

Transient Current Characteristics

Reference

