

Device Modeling Report

COMPONENTS: Halogen Lamp
PART NUMBER: 64478BT SIL
MANUFACTURER: OSRAM GmbH



Bee Technologies Inc.

Transient Current Characteristics

Circuit simulation result

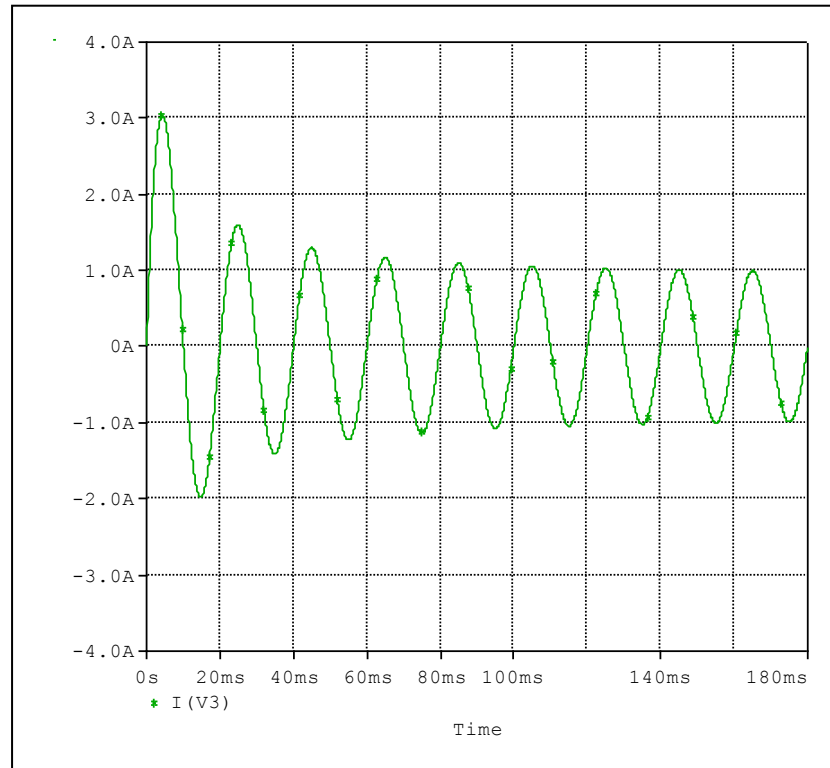

Evaluation circuit

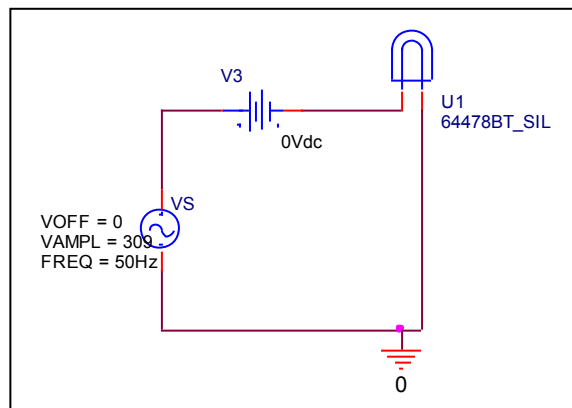

Transient Current Characteristics

Reference

