

Device Modeling Report

COMPONENTS: Solar Cell
PART NUMBER: BP 340
MANUFACTURER: bp Solar
REMARK: Rated power (Pmax) 40W



Bee Technologies Inc.

Output Characteristic

Circuit Simulation Result

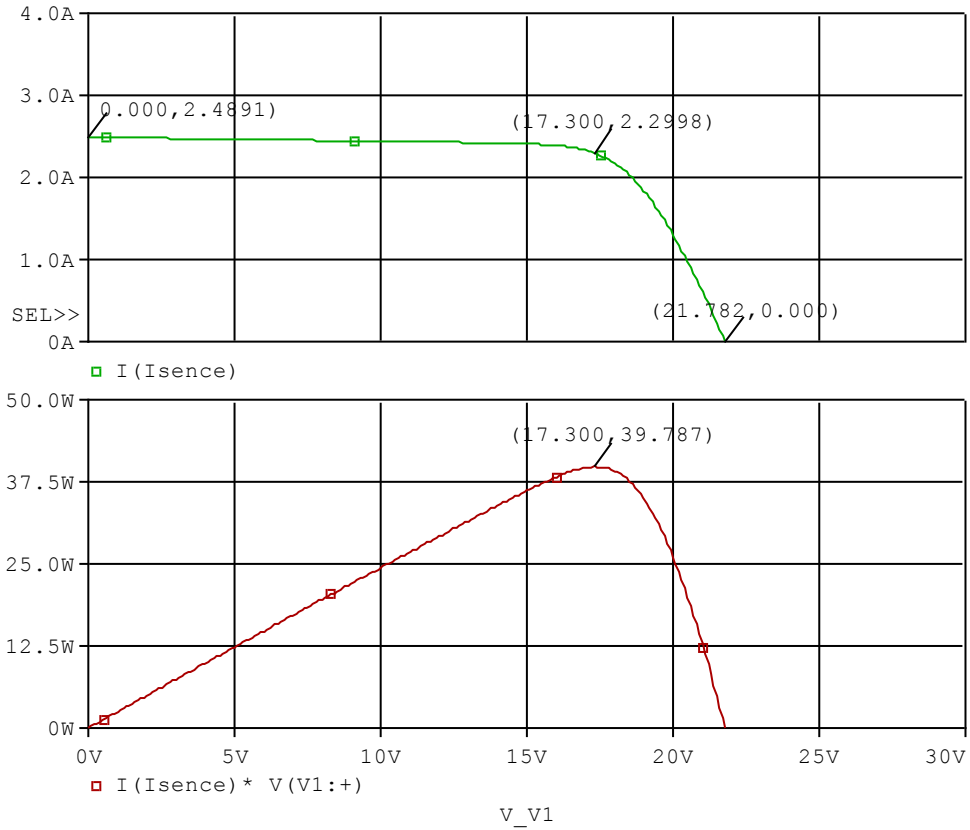

Simulation Circuit

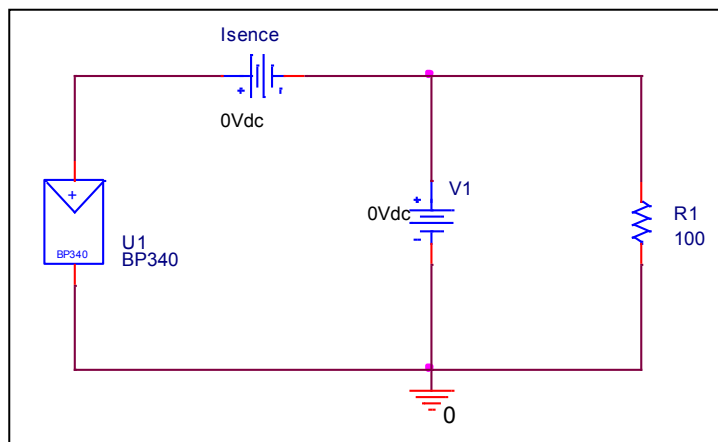

Output Characteristic

Reference

Circuit Simulation Result

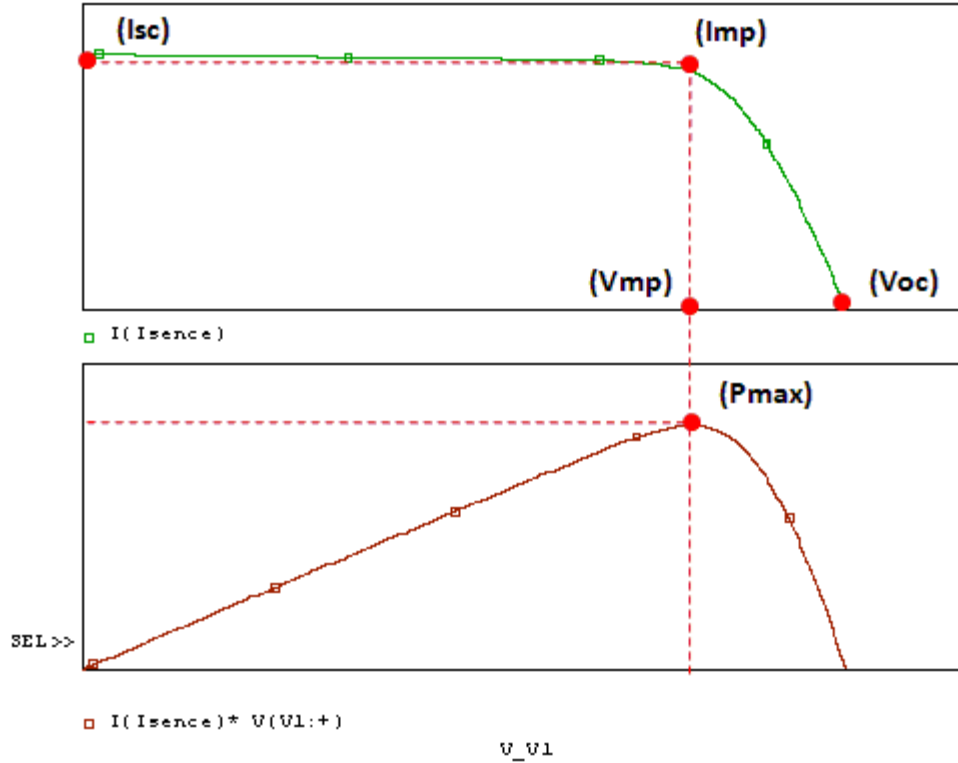

Data Table

Symbol	Measurement	Simulation	%Error
Isc	2.5000	2.4891	-0.436
Voc	21.8000	21.7820	-0.083
Imp	2.3000	2.2998	-0.009
Vmp	17.3000	17.3000	0.000
Pmax(Imp*Vmp)	39.7900	39.7870	-0.008

Data Information

No. BP 340	
Maximum power (Pmax)³	40W
Voltage at Pmax (Vmp)	17.3V
Current at Pmax (Imp)	2.3A
Short-circuit current (Isc)	2.5A
Open-circuit voltage (Voc)	21.8V