

Device Modeling Report

COMPONENTS: Solar Cell
PART NUMBER: BP 380
MANUFACTURER: bp Solar
REMARK: Rated power (Pmax) 80W



Bee Technologies Inc.

Output Characteristic

Circuit Simulation Result

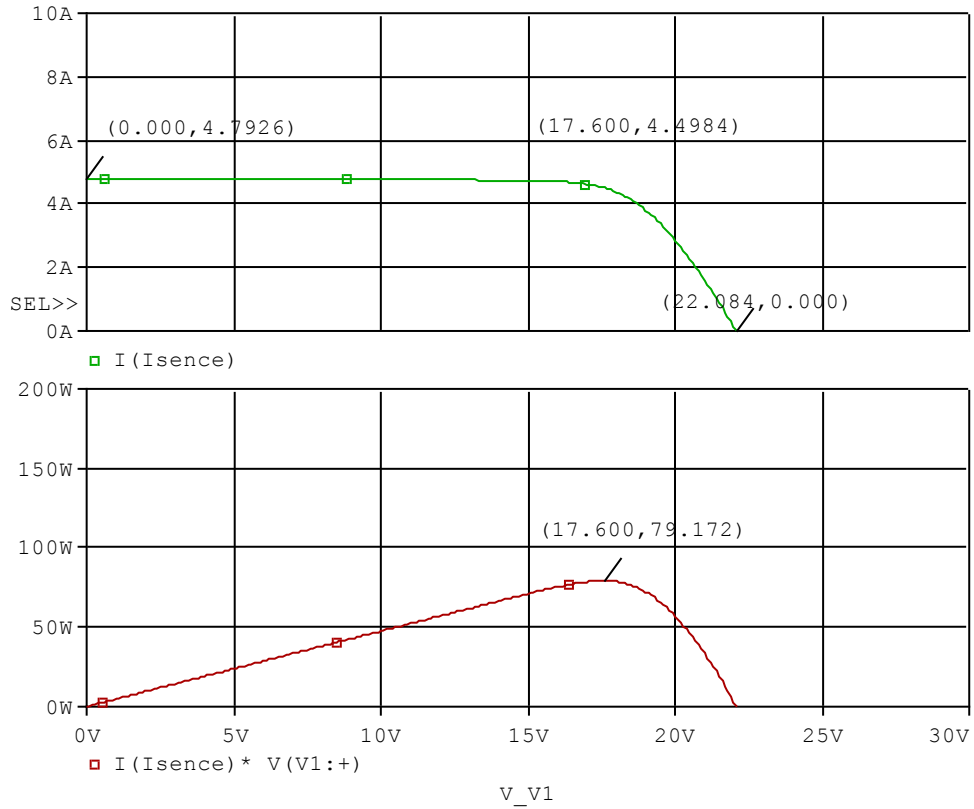

Simulation Circuit

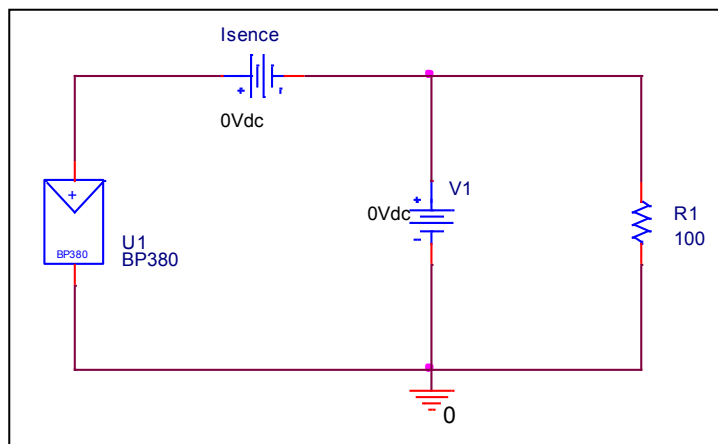

Output Characteristic

Reference

Circuit Simulation Result

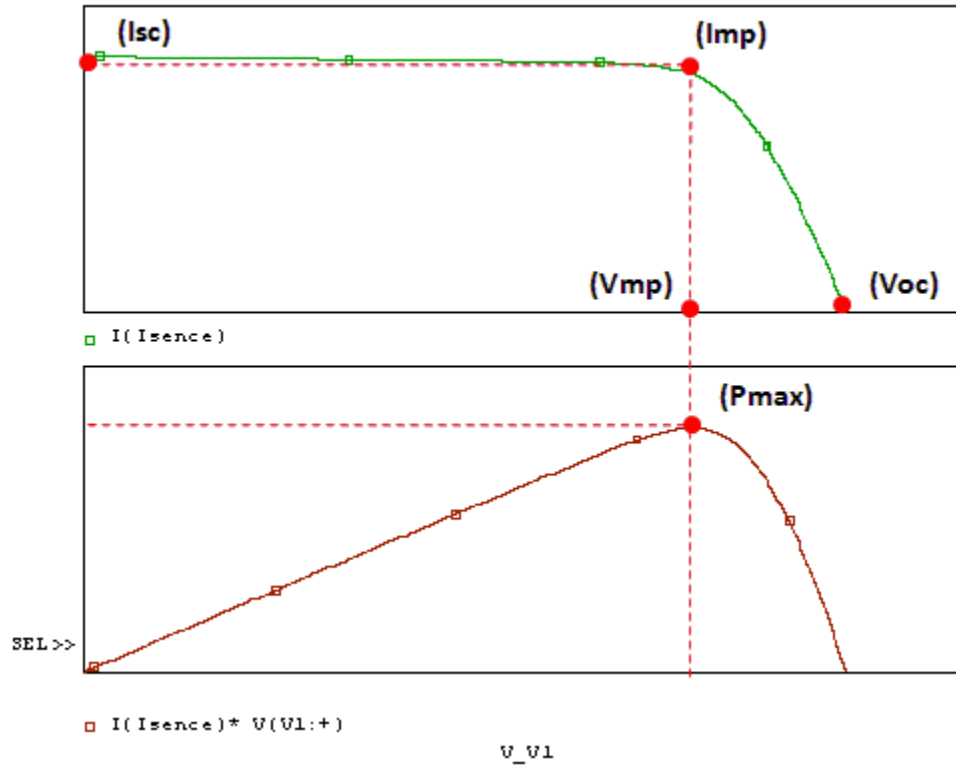

Data Table

Symbol	Measurement	Simulation	%Error
Isc	4.8000	4.7926	-0.154
Voc	22.1000	22.0840	-0.072
Imp	4.5000	4.4984	-0.036
Vmp	17.6000	17.6000	0.000
Pmax(Imp*Vmp)	79.2000	79.1720	-0.035

Data Information

No. BP 380	
Maximum power (Pmax)³	80W
Voltage at Pmax (Vmp)	17.6V
Current at Pmax (Imp)	4.5A
Short-circuit current (Isc)	4.8A
Open-circuit voltage (Voc)	22.1V