

Device Modeling Report

COMPONENTS: Solar Cell
PART NUMBER: BP 3135
MANUFACTURER: bp Solar
REMARK: Rated power (Pmax) 135W



Bee Technologies Inc.

Output Characteristic

Circuit Simulation Result

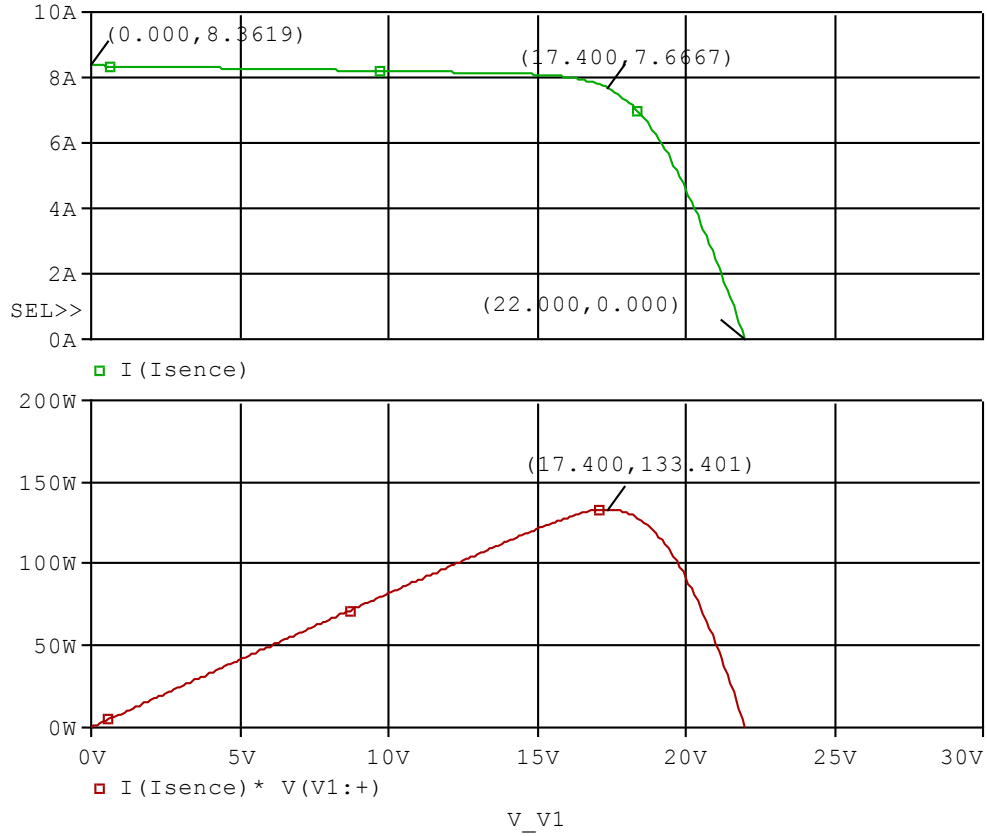

Simulation Circuit

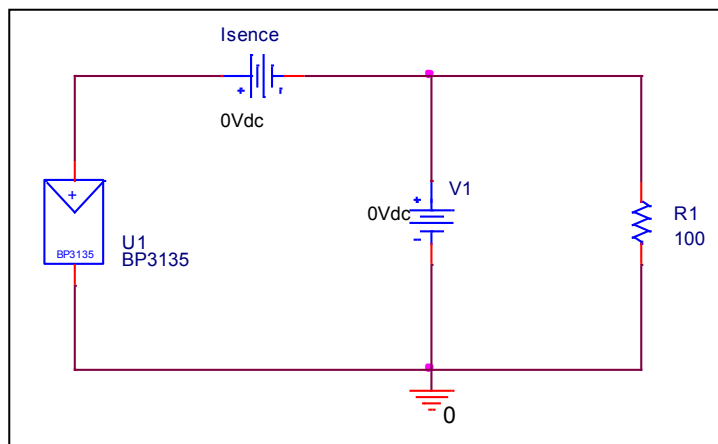

Output Characteristic

Reference

Circuit Simulation Result

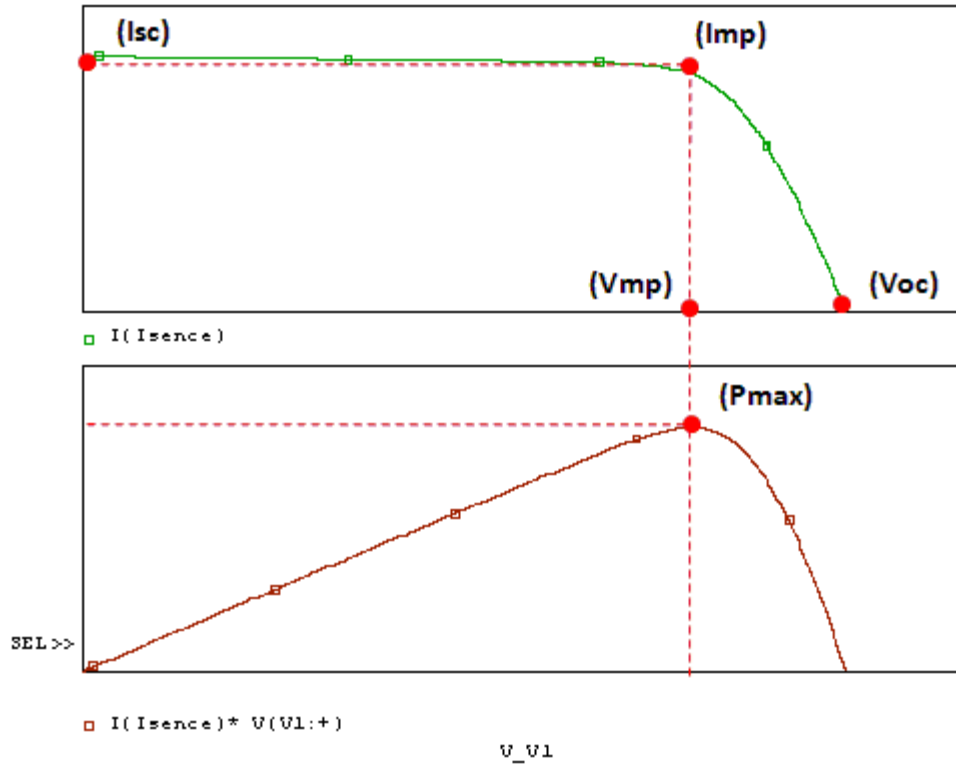

Data Table

Symbol	Measurement	Simulation	%Error
Isc	8.4000	8.3619	-0.454
Voc	22.1000	22.0000	-0.452
Imp	7.7000	7.6667	-0.433
Vmp	17.4000	17.4000	0.000
Pmax(Imp*Vmp)	133.9800	133.4010	-0.432

Data Information

No. BP 3135	
Maximum power (Pmax)³	135W
Voltage at Pmax (Vmp)	17.4V
Current at Pmax (Imp)	7.7A
Short-circuit current (Isc)	8.4A
Open-circuit voltage (Voc)	22.1V