

# Device Modeling Report

COMPONENTS:MAGNETIC CORE  
PART NUMBER:6H40  
MANUFACTURER:FDK



**Bee Technologies Inc.**

## MAGNETIC CORE

Pspice model parameter	Model description
A	thermal energy parameter
K	domain anisotropy parameter
C	domain flexing parameter
MS	magnetization saturation

# Hysteresis Curve Characteristics

## Evaluation Circuit

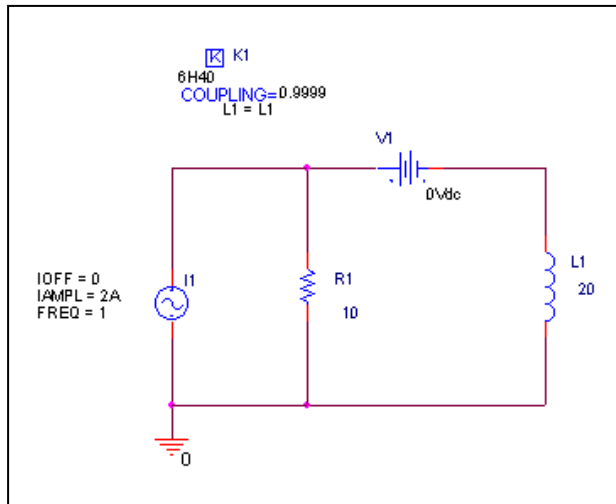

## Simulation result

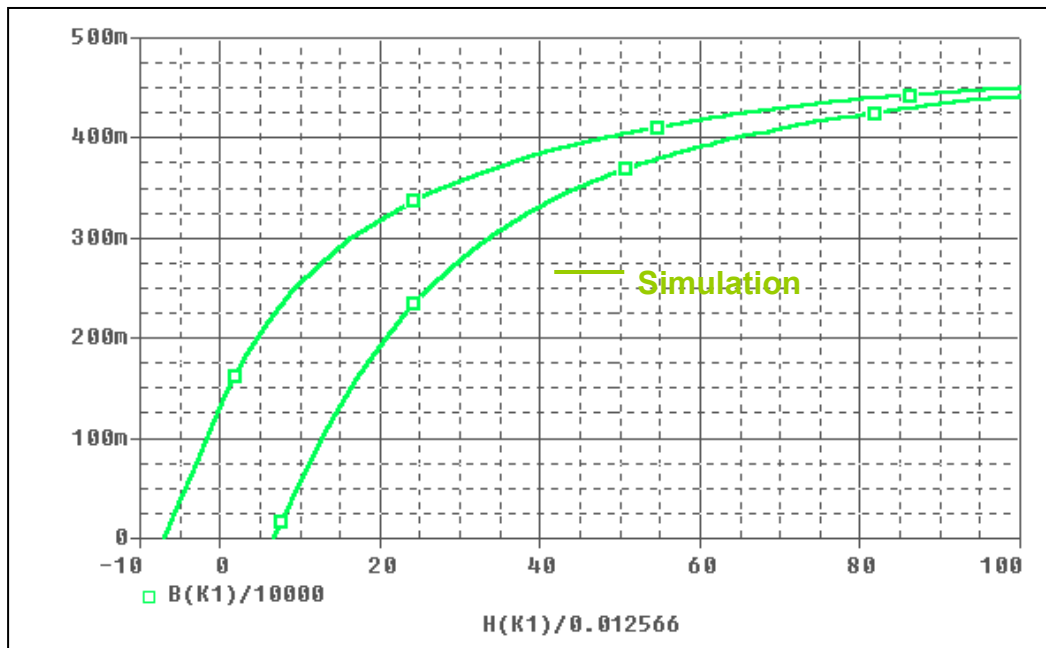

Simulation result

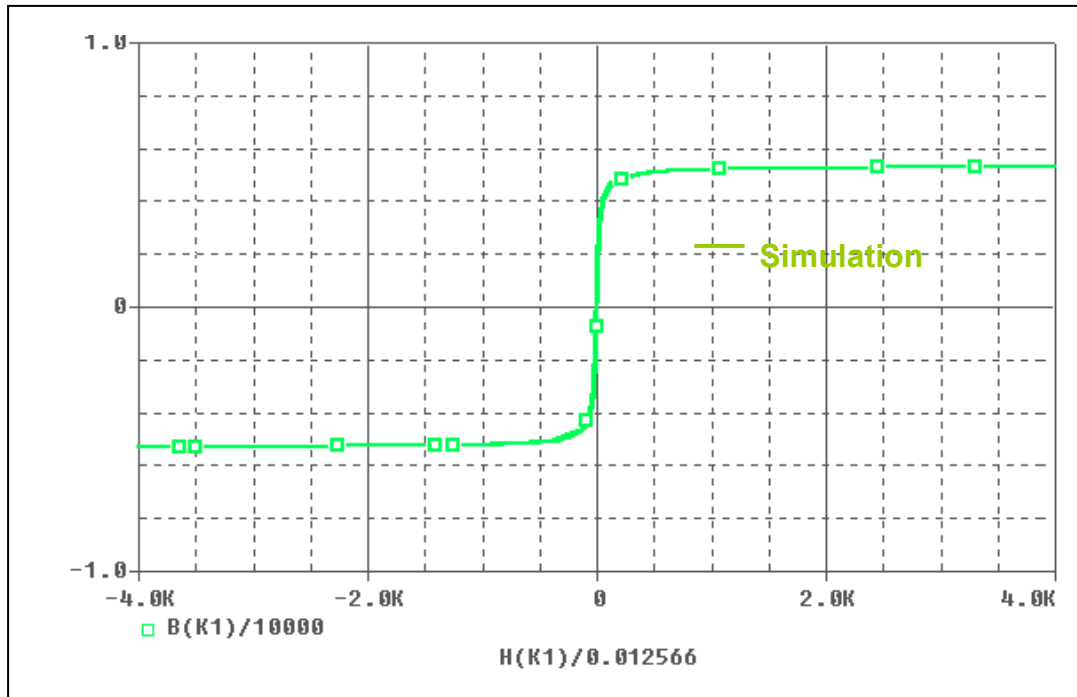

Comparison Table

H(A/m)	B(mT) Measurement	B(mT) Simulation	%Error
0	130	127.66	1.800
20	310	317.505	2.421
30	350	356.425	1.836
40	385	383.586	0.367
50	410	403.37	1.617
60	425	417.618	1.737
70	435	429.104	1.355
80	435	438.832	0.881
90	435	444.811	2.255
100	435	450.66	3.600
40	320	330.508	3.284
50	370	366.894	0.839
60	400	391.225	2.194
70	410	409.043	0.233
80	420	422.756	0.656
90	435	433.6	0.322
100	435	442.281	1.674