

Device Modeling Report

COMPONENTS:MAGNETIC CORE
PART NUMBER:6H41
MANUFACTURER:FDK



Bee Technologies Inc.

MAGNETIC CORE

Pspice model parameter	Model description
A	thermal energy parameter
K	domain anisotropy parameter
C	domain flexing parameter
MS	magnetization saturation

Hysteresis Curve Characteristics

Evaluation Circuit

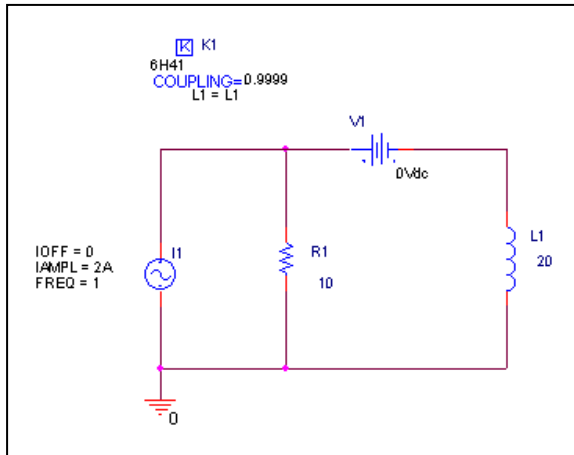

Simulation result

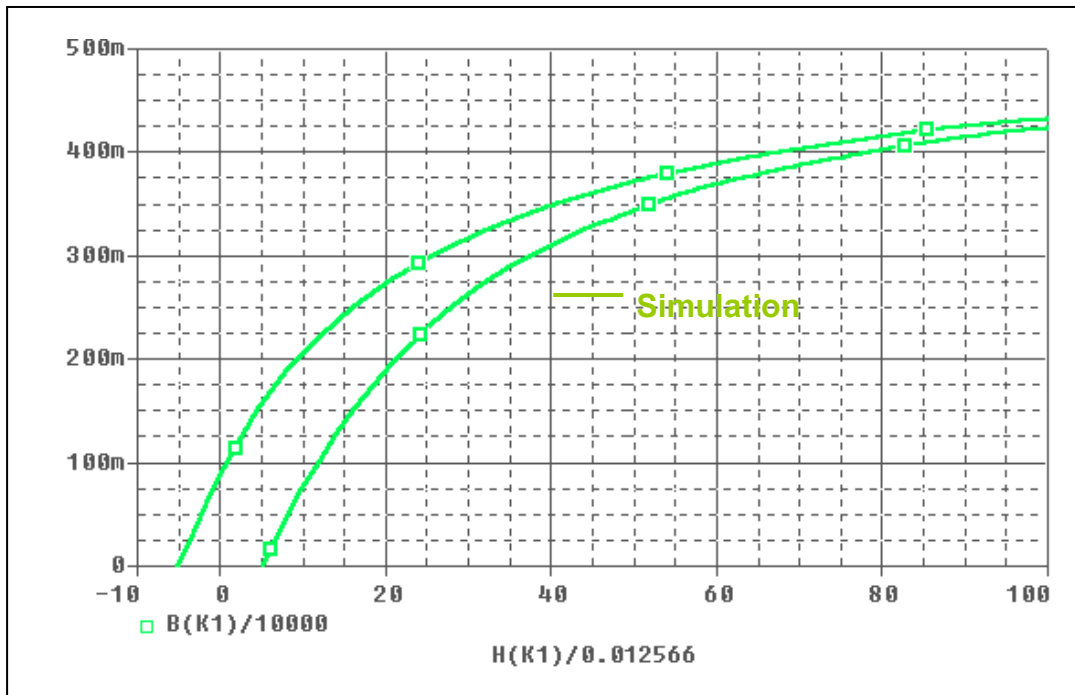

Simulation result

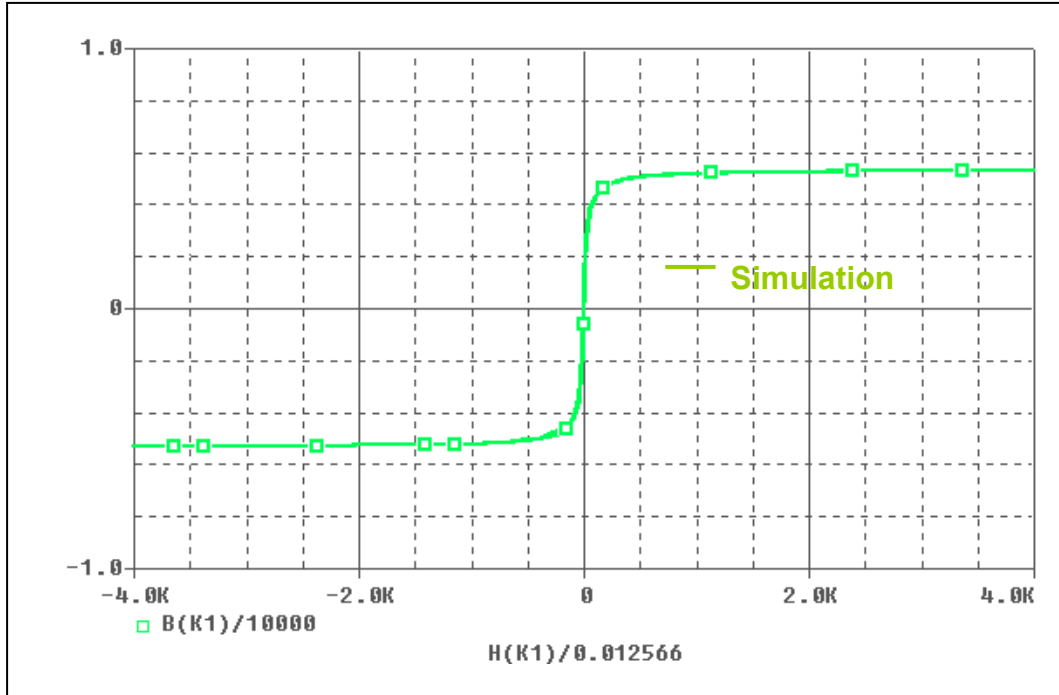

Comparison Table

H(A/m)	B(mT) Measurement	B(mT) Simulation	%Error
10	210	205.219	2.277
20	280	273.074	2.474
30	320	316.659	1.044
40	355	348.222	1.909
50	380	371.597	2.211
60	400	388.812	2.797
70	410	403.002	1.707
80	420	414.481	1.314
90	425	424.569	0.101
100	430	431.948	0.453
40	300	309.95	3.317
50	350	343.978	1.721
60	380	368.285	3.083
70	400	386.922	3.269
80	420	401.54	4.395
90	425	413.805	2.634
100	430	423.649	1.477