

# Device Modeling Report

COMPONENTS:MAGNETIC CORE  
PART NUMBER:3C92  
MANUFACTURER:FERROXCUBE



**Bee Technologies Inc.**

## MAGNETIC CORE

Pspice model parameter	Model description
A	thermal energy parameter
K	domain anisotropy parameter
C	domain flexing parameter
MS	magnetization saturation

# Hysteresis Curve Characteristics

## Evaluation Circuit

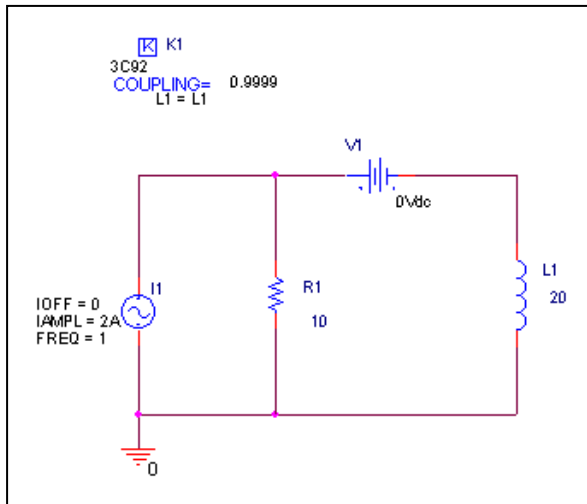

## Simulation result

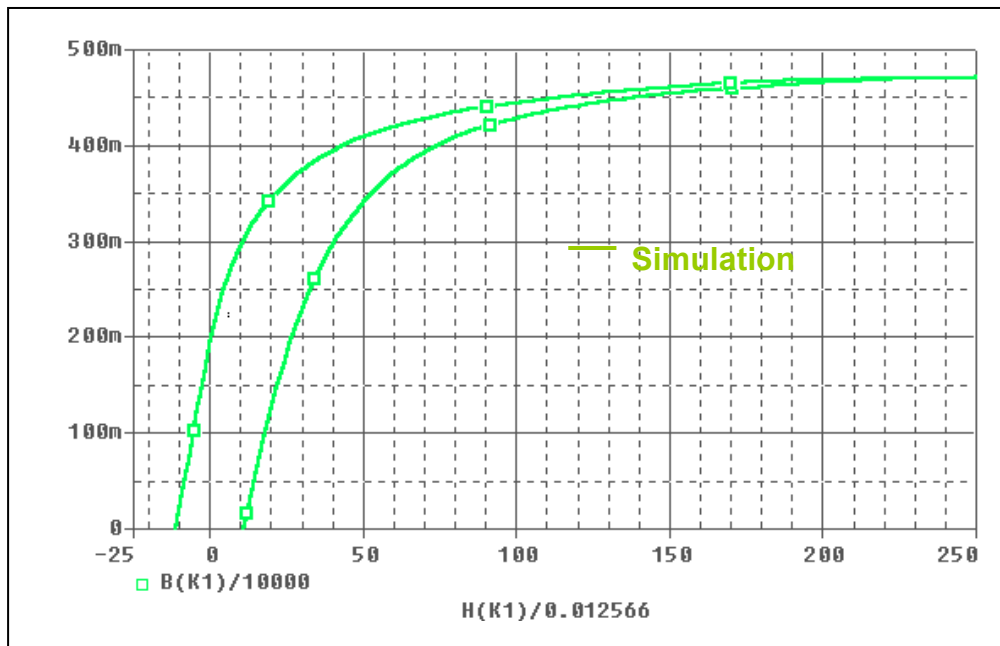

Simulation result

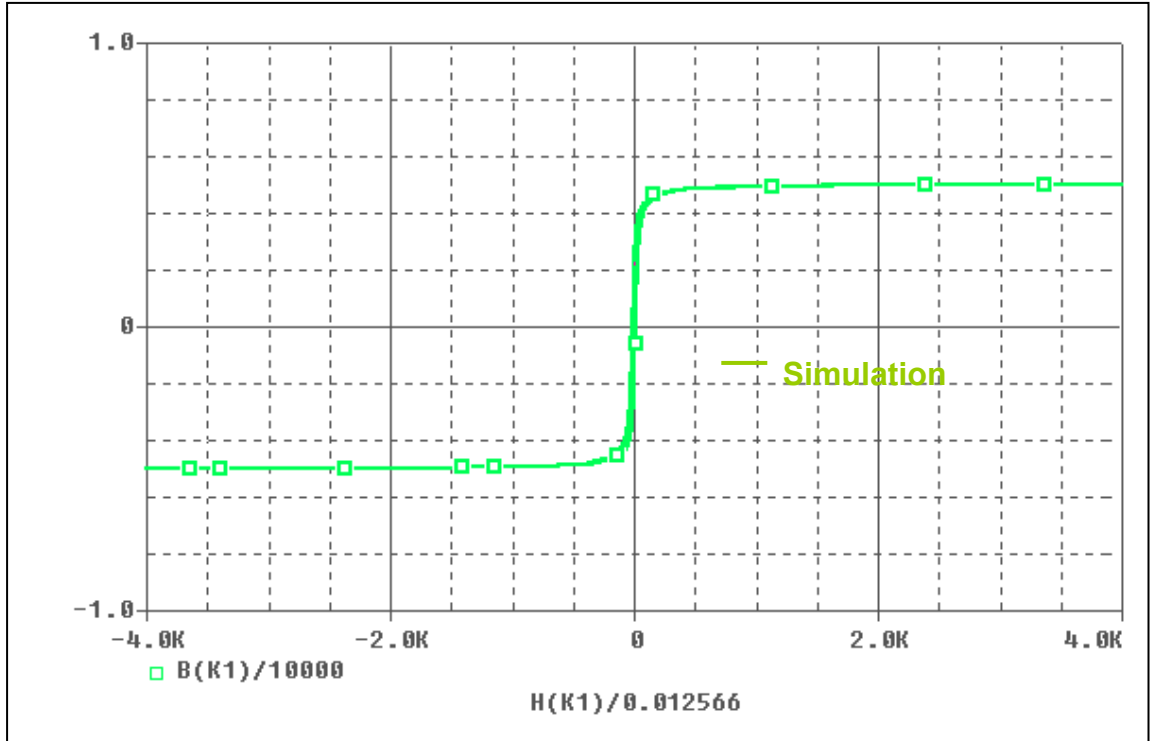

Comparison Table

H(A/m)	B(mT) Measurement	B(mT) Simulation	%Error
50	410	408.446	0.379
75	440	431.582	1.913
100	450	443.979	1.338
125	460	454.641	1.165
150	465	460.26	1.019
175	470	465.961	0.859
200	470	467.805	0.467
225	470	469.732	0.057
250	470	471.617	0.344
75	415	401.264	3.310
100	430	428.789	0.282
125	450	444.086	1.314
150	455	453.677	0.291
175	468	460.533	1.596
200	470	465.256	1.009
225	470	469.195	0.171
250	470	472.327	0.495