Specification for Approval

Customer : **Linkman Co.,Ltd.**

Part Name : **AC ADAPTER**

Description : **24 Volts / 2.71 Amps**

Model No. : **ATS065-A240 (Level V)**

Customer P / N :

Product P / N : **ATS065A240415202**

Issued Date : **21-Dec.-2013**

Version : **A2**

Issued Stamp :

Customer's Approval Signature

65 W
AC ADAPTER
SPECIFICATION

Model No. : **ATS065-A240 (Level V)**

Description : **24 Volts / 2.71Amps**

Part No. : **ATS065A240415202**

Version : **A2**

Date : **21-Dec.-2013**

Approved	Reviewed	Checked	Prepared	Sales

1. Feature :

- ◆ **Input** : **Universal 100 ~ 240 Vac / 50 ~ 60 Hz Input, without any slide switch.**
- ◆ **Output** : **+24V / 0~2.71A**
- ◆ **Case Dimension** : **115 (L) *53 (W) * 38 (H) mm**
- ◆ **Efficiency** : **Eff (av) \geq 87%**
- ◆ **Safety** : **UL / cUL / GS / PSE / BSMI / CB / RCM**
- ◆ **EMI** : **CE / FCC Class B ; Conduction & Radiation Met.**
- ◆ **Protection** : **OVP (Over Voltage Protection) 、 SCP (Short Circuit Protection) 、 OCP (Over Current Protection)**
- ◆ **High frequency design , less power consumption.**
- ◆ **Suitable for usage at Telecommunication, Computer, Industrial Controller, & OA System.**
- ◆ **Meet DoE / ErP (Stage 2) / GEMS / NRCan**

2. Input :

2.1 Voltage	Universal 100~240Vac, single phase
2.2 Frequency	50 ~ 60 Hz
2.3 Current	1.4A Max.
2.4 Inrush Current	80A Max. / 240Vac (Cold start at 25 °C , full load)
2.5 Efficiency	Eff (av) \geq 87% (At 115 Vac & 230 Vac)
2.6 Power Consumption	Pi \leq 0.5 W (At 230Vac & No load)

$$\text{※Eff (av)} = \frac{E_1 + E_2 + E_3 + E_4}{4}$$

E1=efficiency with 25% rated load ; E2= efficiency with 50% rated load
E3=efficiency with 75% rated load ; E4= efficiency with 100% rated load

3. Output :

3.1 DC Output	Voltage	+24 V \pm 5%
	Current	2.71A Max.
	Regulation	22.80Vmin. ~ 24.00Vtyp. ~ 25.20Vmax.
	Ripple & Noise	240mV Max.
	Total Power	65 W Max.

Remark : For ripple & noise measurement, use a 20MHz bandwidth frequency oscilloscope, and add a 0.1 μ F multilayer Cap. and a Low ESR Electrolytic Cap. (10 μ F) at output connector terminals. (At nominal line voltage, full load)

4. Protection :

4.1 Over Voltage Protection (OVP)	(V out *150%) Max.
4.2 Short Circuit Protection (SCP)	Automatic recovery after short-circuit fault being removed
4.3 Over Current Protection(OCP)	(I out *180%) Max.

Remark : When Short Circuit Protection or Over Current Protection is activated,the power supply will shutdown automatically. Once the abnormal condition resulting in the failure being removed, the power supply will restart accordingly. When Over Voltage Protection is activated, the power supply will shutdown latch .

5. Safety 、EMI and EMC Requirement :

5.1 Safety Requirement

a. Safety : UL / cUL / GS / PSE / BSMI / CB / RCM

b. Dielectric Strength : Cut off current 10mA

	Primary to Secondary	3000Vac for 1 Minute
--	----------------------	----------------------

c. Insulation Resistance :

	Primary to Secondary	10 M ohm for 500Vdc
--	----------------------	---------------------

5.2 EMI Requirement : CE / FCC Class B ; Conduction & Radiation Met.

5.3 Leakage Current : Less than 0.25 mA

6. Operation and Environment Performance :

6.1 Temperature Range

Operating	+ 0°C ~ + 40°C
Storage	- 20 °C ~ + 80°C

6.2 Humidity Range(Non-condensing)

Operating	20% ~ 80% RH
Storage	10% ~ 90% RH

6.3 Cooling : By natural air.

7. M.T.B.F. : 300,000 Hrs.(Calculated Hours At 25°C , By Telcordia SR-332)

8.Mechanical :

8.1 Weight : 280 Typical

8.2 Cable Type : Black UL2468 AWG18
(Wire + Plug)

Plug : $\phi 5.5 * \phi 2.1 * 9.5\text{mm}$

(Tuning Fork & Cannelure)

8.3 Cable Length : 1500mm

8.4 Case Dimension : 115mm(L)*53mm(W)*38mm(H)

8.5 Material Flammability : UL 94V-0

8.6 External Apperance : As drawing below (Scale \rightarrow mm)

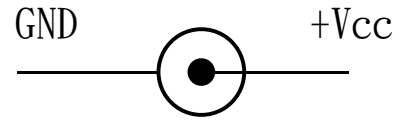

Output Cable Plug Pin Assignment

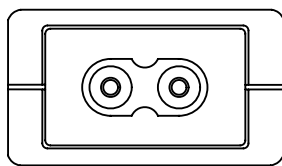
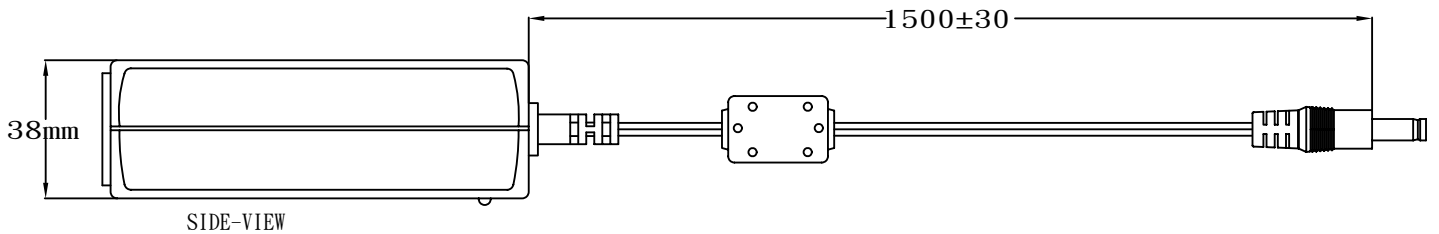
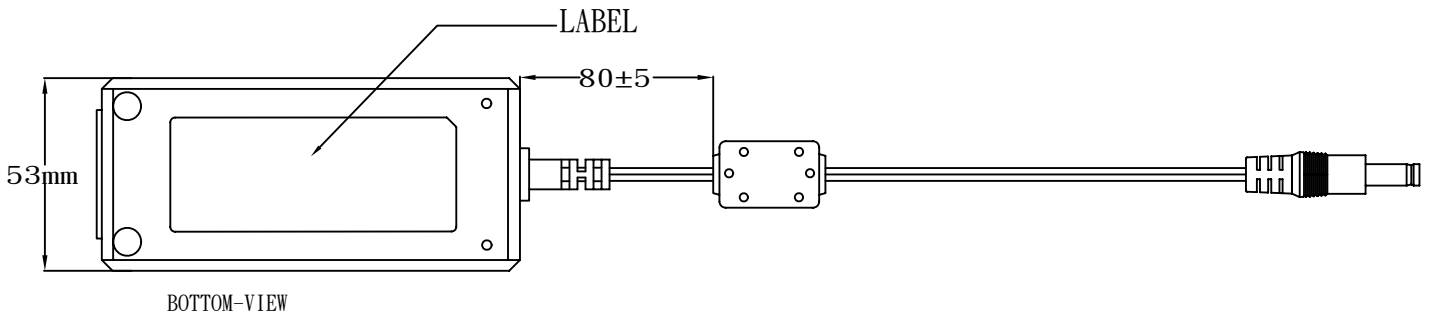
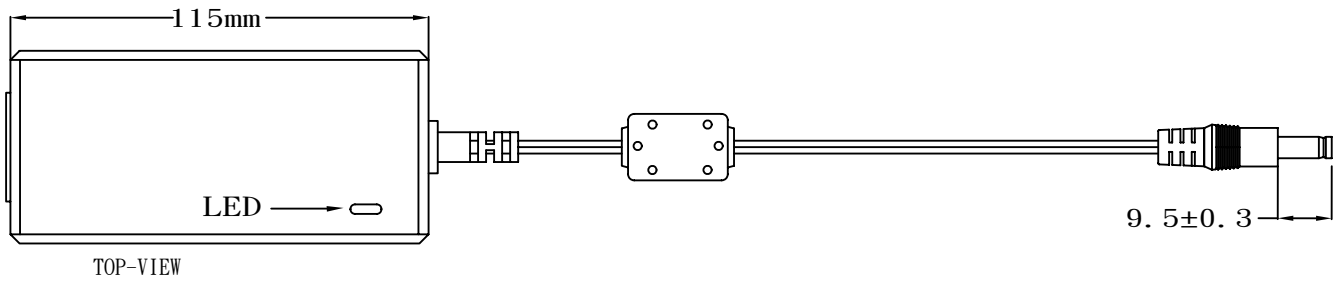
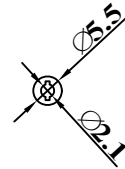

8.7 Spec. Label Materials : Metalized Polyester Label (Silver Gloss)
Color : Black Background with Silver Printing
Label Dimension : 70.8mm(L)*40.4mm(W)+/-0.1mm
Label Thickness : 75#

100%

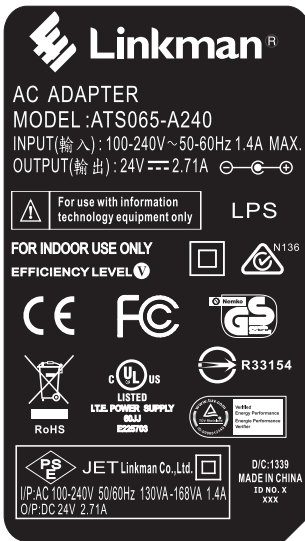

"XXX"

Label supplier's code.
It is accurate that the number of words depends on the real finished product.

ID NO. "X"

Manufacturer's code.
It is accurate that the number of words depends on the real finished product.

200%

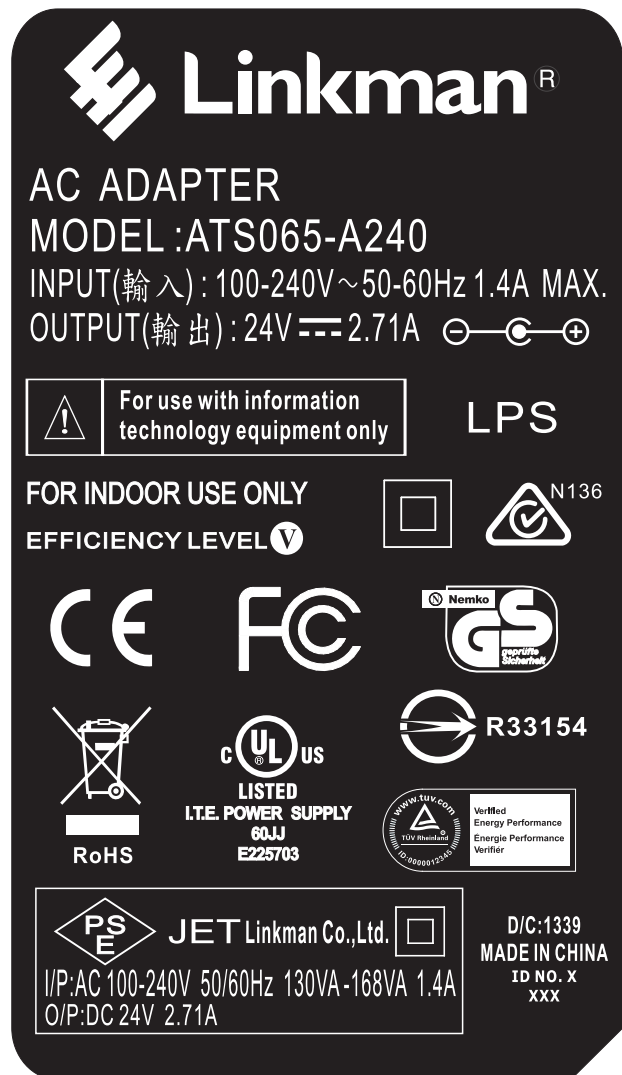

Label Part No.:9443041990
REV.:A

A. Line Regulation Test

Test Result :

Test condition	Spec.	Reading 1	Reading 2	Reading 3
90Vac / 50 % Load	22.8V ~ 25.2 V	23.77 V	23.77 V	23.80 V
115Vac / 50 % Load	22.8V ~ 25.2 V	23.78 V	23.78 V	23.81 V
132Vac / 50 % Load	22.8V ~ 25.2 V	23.80 V	23.78 V	23.80 V
180Vac / 50 % Load	22.8V ~ 25.2 V	23.79 V	23.77 V	23.80 V
230Vac / 50 % Load	22.8V ~ 25.2 V	23.80 V	23.78 V	23.81 V
264Vac / 50 % Load	22.8V ~ 25.2 V	23.82 V	23.78 V	23.80 V

B. Efficiency Test

Test Result :

Test condition	Spec.	Reading 1	Reading 2	Reading 3
115Vac	87 % Min.	87.64 %	87.76 %	87.74 %
230Vac	87 % Min.	88.04 %	88.12 %	88.08 %

$$\text{Eff (av)} = \frac{E_1 + E_2 + E_3 + E_4}{4}$$

E1=efficiency with 25% rated load ; E2= efficiency with 50% rated load
E3=efficiency with 75% rated load ; E4= efficiency with 100% rated load

C. Load Regulation Test

Test Result :

Test condition	Spec.	Reading 1	Reading 2	Reading 3
115Vac / 0 % Load	22.8V ~ 25.2 V	23.98 V	23.94 V	24.01 V
115Vac / 50 % Load	22.8V ~ 25.2 V	23.78 V	23.77 V	23.80 V
115Vac / 100 % Load	22.8V ~ 25.2 V	23.62 V	23.60 V	23.64 V
230Vac / 0 % Load	22.8V ~ 25.2 V	23.98 V	23.95 V	24.00 V
230Vac / 50 % Load	22.8V ~ 25.2 V	23.80 V	23.79 V	23.81 V
230Vac / 100 % Load	22.8V ~ 25.2 V	23.66 V	23.62 V	23.66 V

D. Ripple & Noise Test

Test Result :

Test condition	Spec.	Reading 1	Reading 2	Reading 3
115Vac / 100 % Load	240mV Max.	91.4 mV	88.5 mV	92.3 mV
230Vac / 100 % Load	240mV Max.	88.2 mV	86.5 mV	91.1 mV

E. Inrush Current

Test Result :

Test condition	Spec.	Reading 1	Reading 2	Reading 3
240Vac / 100 % Load	80A Max	63A	66A	65A

F. Over Current Protection

Test Result :

Test condition	Spec.	Reading 1	Reading 2	Reading 3
115Vac / 100 % Load	(I out *180%) Max.	128%	126%	127%
230Vac / 100 % Load	(I out *180%) Max.	125%	124%	125%

G. Short Circuit Protection

Test Result :

Test condition	Spec.	Reading 1	Reading 2	Reading 3
115Vac / 100 % Load	Auto Recovery	OK	OK	OK
230Vac / 100 % Load	Auto Recovery	OK	OK	OK

H. Input Power Consumption(No Load)

Test Result :

Test condition	Spec.	Reading 1	Reading 2	Reading 3
230Vac / 0 % Load	≤ 0.5 W	0.36 W	0.35W	0.36W

Efficiency Test Report

- A. Model Number** : ATSO65-A240 (24.0V/2.71A/65.0W)
B. DC Power Cord : UL2468,18AWG,1.5M
C. Average Efficiency :
LEVEL V : 87%Min.
D. NO Load Power Consumption :
LEVEL V : 0.5W max.
E. Testing equipment :
1. AC Power Source : " ALL POWER " APW-110N
2. Electronic Load : " PRODIGIT " 3311C
3. Power Meter : " YOKOGAWA " WT210
4. Digital Meter : " FLUKE " 79III
F. AC Input Voltage : 115Vac/60Hz

Load Conditions Reported Quantity	100%* I ₀	75%* I ₀	50%* I ₀	25%* I ₀	0%* I ₀
Rms Output Current(mA)	2710mA	2033mA	1355mA	678mA	0mA
Rms Output Voltage(V)	23.620V	23.700V	23.780V	23.850V	23.980V
Active Output Power(W)	64.01W	48.17W	32.22W	16.16W	0.00W
Rms Input Voltage(V)	115V	115V	115V	115V	115V
Rms Input Current(A)	1.176A	0.924A	0.673A	0.373A	0.016A
Rms Input Power(W)	73.50W	54.60W	36.43W	18.62W	0.26W
Voltage T.H.D.(%)	0.57	0.51	0.42	0.28	0.11
True Power Factor	0.540	0.510	0.466	0.425	0.145
Power Consumed by UUT(W)	9.49W	6.43W	4.21W	2.46W	0.26W
Efficiency	87.09%	88.22%	88.45%	86.78%	*
Average Efficiency	87.64%				*

- G. AC Input Voltage** : 230Vac/50Hz

Load Conditions Reported Quantity	100%* I ₀	75%* I ₀	50%* I ₀	25%* I ₀	0%* I ₀
Rms Output Current(mA)	2710mA	2033mA	1355mA	678mA	0mA
Rms Output Voltage(V)	23.660V	23.730V	23.800V	23.870V	23.980V
Active Output Power(W)	64.12W	48.23W	32.25W	16.17W	0.00W
Rms Input Voltage(V)	230V	230V	230V	230V	230V
Rms Input Current(A)	0.732A	0.558A	0.384A	0.211A	0.235A
Rms Input Power(W)	73.15W	54.12W	36.12W	18.78W	0.36W
Voltage T.H.D.(%)	0.50	0.41	0.32	0.23	0.11
True Power Factor	0.429	0.419	0.407	0.384	0.067
Power Consumed by UUT(W)	9.03W	5.89W	3.87W	2.61W	0.36W
Efficiency	87.65%	89.12%	89.28%	86.11%	*
Average Efficiency	88.04%				*

Tester : Mingan

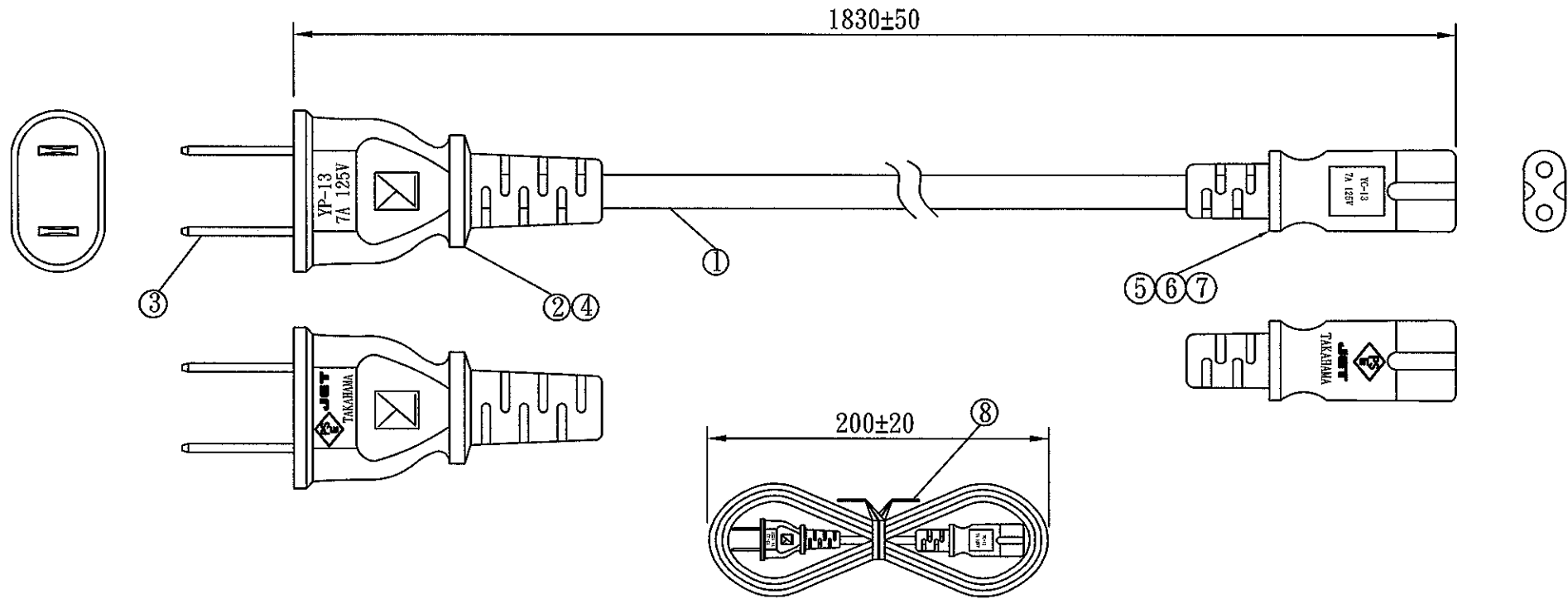

線材印字:

◁PS> E JET TAKAHAMA VCTFK 2X0.75mm² 20XX -F-

序號	名稱	用量	備注
1	PSE規格:VCTFK 2x0.75mm ² 黑色	1PC	1810±20(YL)
2	YP-13 黑色50P膠料	15g/PC	
3	銅片:98675BS-1	2PCS	
4	兩插內模	1PC	
5	YC-13 黑色50P膠料	9g/PC	
6	三爪磷青銅管	2PCS	
7	"8"字內模 黑色	1PC	
8	魔帶:L=130mm 黑色	1PC	

一般寸法公差: >0±0.30 >1.0±0.50 >10.0±1.0 >20.0±2.0 Angle:±1°	核准		日期				
	審核		日期				
	制圖		日期		客戶		
	型號	YP-13/YC-13		客戶料號	R426A11801A		
圖號	CY-P0061	版本	B	材質	P.V.C	單位	mm
				單重(g)			

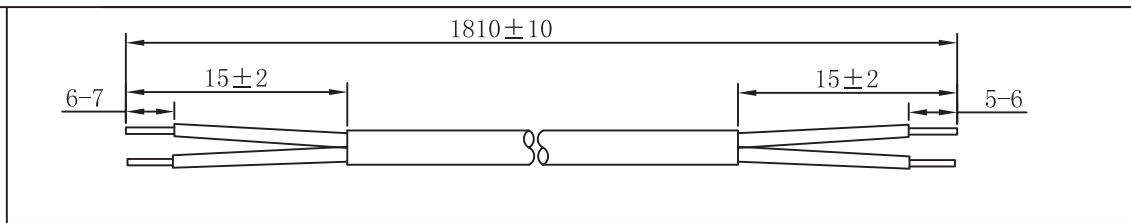

版本	改变内容	制作人	日期
A/0	初版发行	彭力	2013/09/27

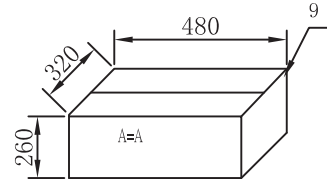
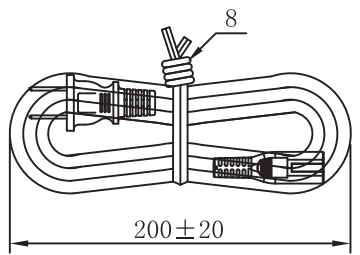
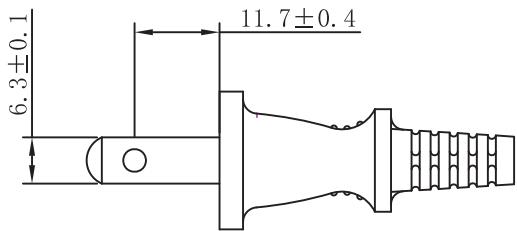
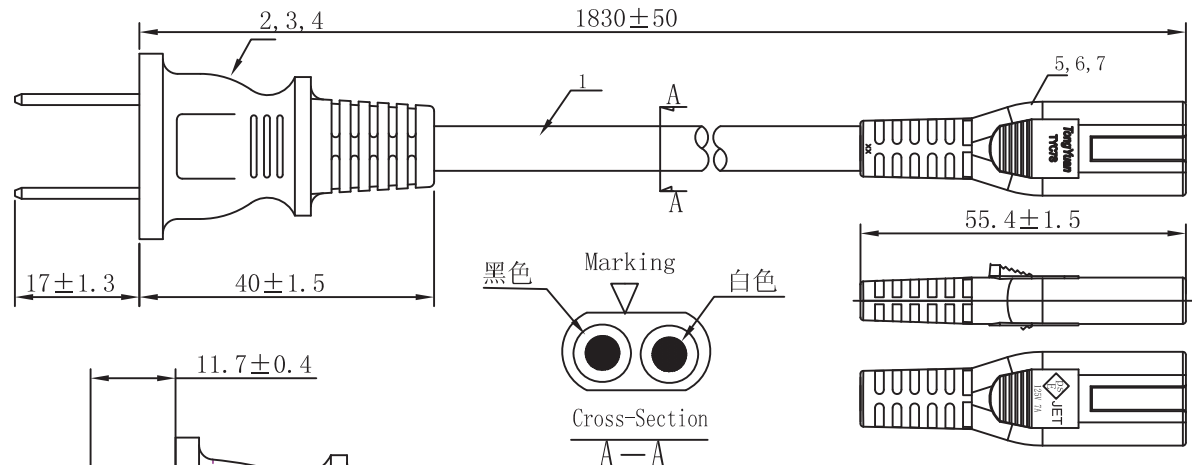
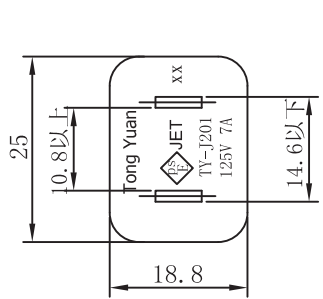

9	纸箱A=A 48*32*26CM 普通	41-0001N	0.0067PCS
8	PE扎带,黑色,6"	52-0006N	1PCS
7	C7连接器塑料内架	82-0002N	1PCS
6	C7连接器插套	92-0012N	2PCS
5	普通插头PVC 黑色 75A	12-P700175-100N	0.008KG
4	普通插头PVC 黑色 75A	12-P700175-100N	0.011KG
3	插头二插内架	81-0005N	1PCS
2	插头片状日本全裸端子	91-0023N	2PCS
1	PSE VCTFK 2X0.75 黑色 油印	T15035-7001N	1810MM
S/N	DESCRIPTION	ITEM NO	QTY

电线印字(油印)
 <PS>E JET TYAI S. TONGYUAN. I VCTFK 2×0.75mm² --F-- XXXX LF
 XXXX表示生产年份

导体		绝缘		外被	
导体 标称截面积 (AWG/MM ²)	导体结构 (根数/MM)	绝缘 标称厚度 (MM)	标称直径 (MM)	绝缘 标称厚度 (MM)	标称直径 (MM)
0.75	30/0.18	0.54	2.35 ± 0.05	0.9	4.3 ± 0.1 × 6.6 ± 0.15

装箱要求:
 1. 10PCS 每把.
 2. 每箱装 150 pcs

标题		日本两插连八字尾		公差	版本	A/0
客户名				x.xx ± 0.3 x.x ± 0.5 x ± 1 角度 ± 1°	页码	1 / 1
客户产品代码		R426AF18312				
通源代码		T0259-J201C701N		Third Angle		
单位	MM	制作	彭力	检查		
比例	/	日期	2013/09/27	日期		

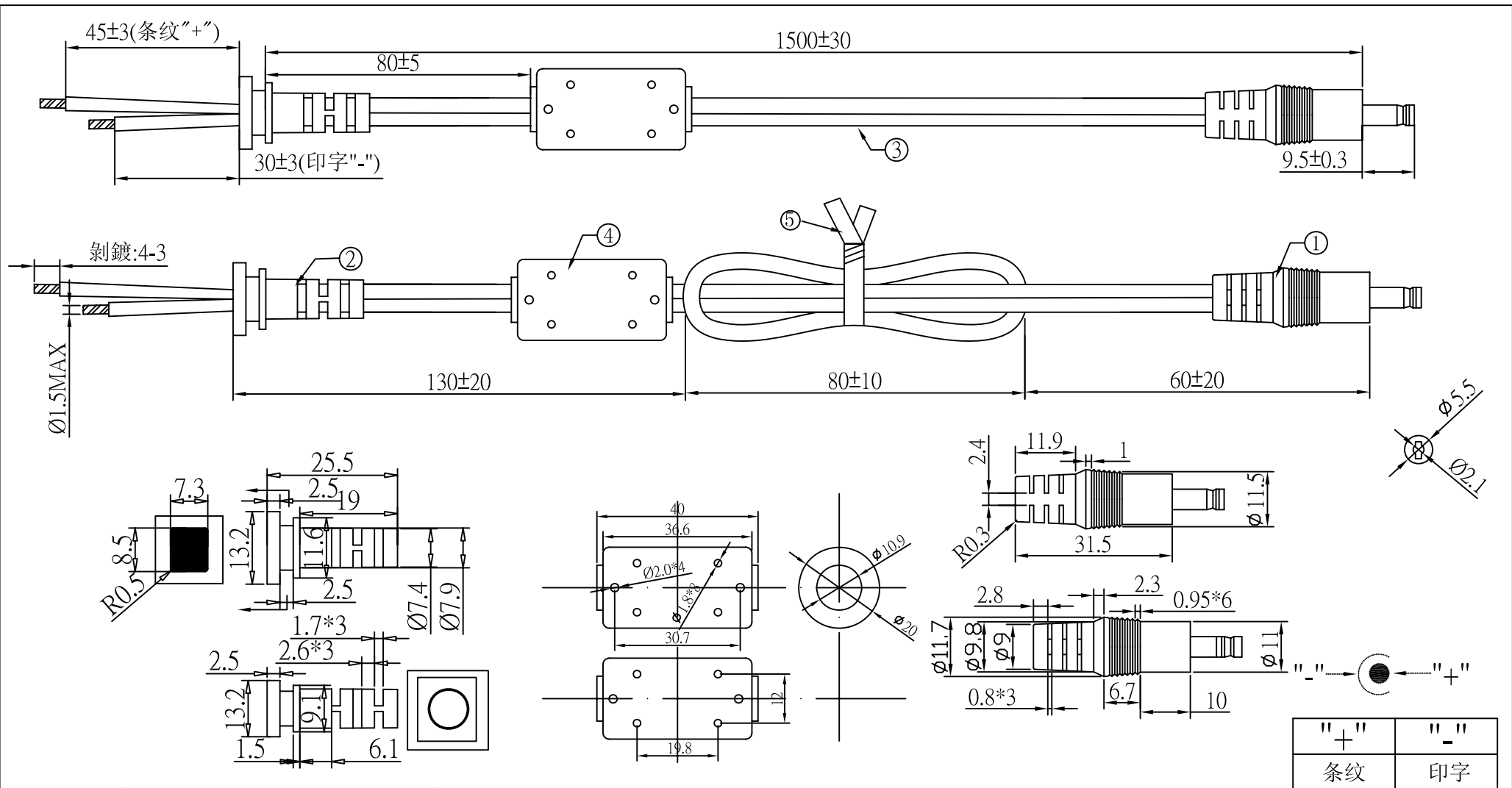

注意:此圖面所需材料符合"ROHS"標準

- ① 5.5*2.1*23音叉車溝黑色半邊(Y Y-PD-00186),外模P-184號模(二次成型),用料外PVC60P黑色(Y Y-PV-00009)
- ② SR-348(A)號模,用料PVC75P黑色(Y Y-PV-00031),吊重:1米/20磅/60秒
- ③ UL 2468 18AWG(0.16*41) BK OD:2.2*4.4 (Y Y-DC-00091)裁線長度:1560+10/-0
- ④ 鐵芯規格:14.2*28.5*6.35(Y Y-CR-00009),外模SR-118號模用料PVC60P黑色(Y Y-PV-00009)
- ⑤ PE有鐵芯紮帶10CM黑色(Y Y-ES-00001)
- ⑥ 絕緣阻抗:20Ω,導通阻抗:1.5Ωmax
- ⑦ 單位:MM

料號	R44M1G1501L		
客戶		制圖	谈怀用
版次	02	審核	
頁數	01	批准	
圖號	ADT-0950	日期	2008/11/13

版次	內容
02	SR模号