

THIS DRAWING IS UNPUBLISHED.

RELEASED FOR PUBLICATION

© COPYRIGHT

ALL RIGHTS RESERVED.

LOC	DIST	REVISIONS			DATE	DWN	APVD
J	-	P	LTR	DESCRIPTION			
				C1 REVISED PER ECO-11-005030	14APR11	RK	HMR

-1:本図
-1:AS SHOWN

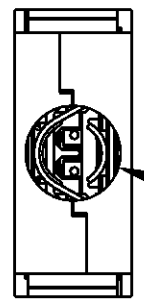
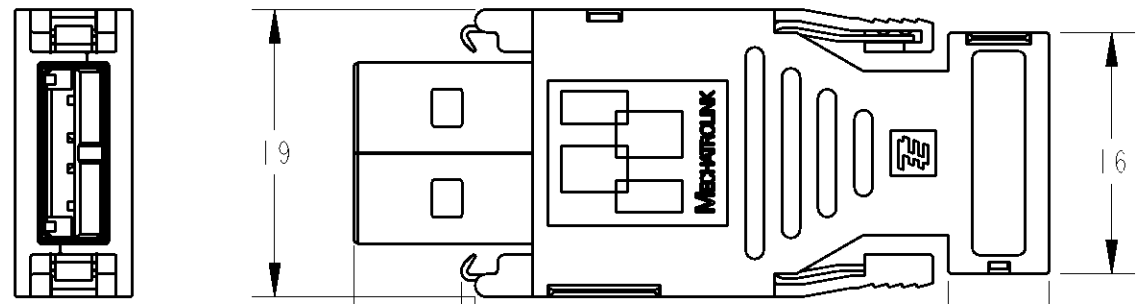

- 適合電線: 大電(株)製(HRZFV-SB AWG25×2心)
- D/Cは同梱の顧客用図面(図面名称欄内)に記載
- 取扱説明書: 411-78259

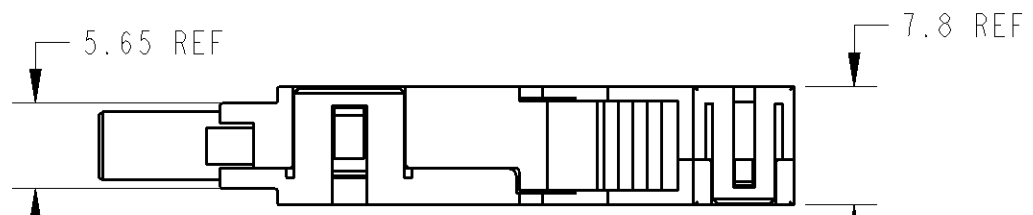
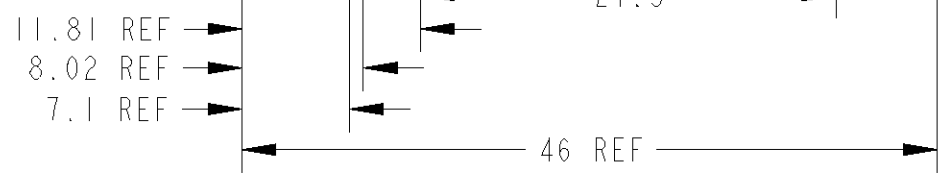

- ACCEPTABLE WIRE: DAIDEN Co. Ltd. (HRZFV-SB AWG25×2C)
- D/C IS DESCRIBED IN THE BUNDLED CUSTOMER DRAWING (IN DRAWING NAME COLUMN).
- INSTRUCTION SHEET: 411-78259

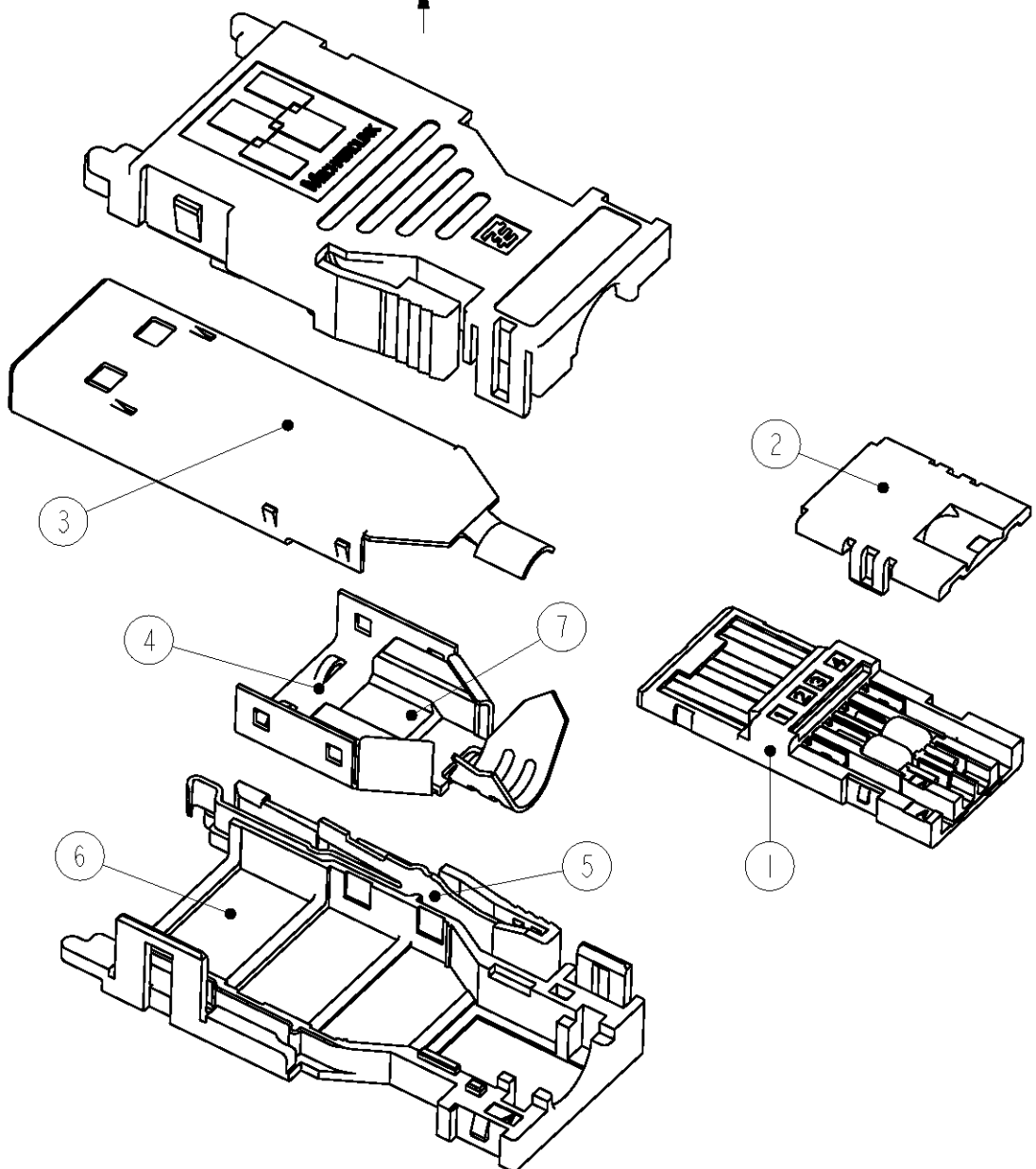

1	POLYAMIDE OF GLASS FILLED PLASTIC(UL94V-0) ガラス入りポリアミド系樹脂 UL94V-0	RETENTION HSG リテンション ハウジング	7
2	OLYESTER OF GLASS FILLED THERMO PLASTIC(UL94V-0) ガラス入り熱可塑性ポリエステル系樹脂 UL94V-0	COVER HSG カバー ハウジング	6
2	STAINLESS STEEL ステンレス鋼	LOCK SPRING ロック スプリング	5
1	STEEL/UNDER: COPPER PLATING, TOP: Ni PLATING 鋼/下地: 銅めっき, 表面: ニッケルめっき	BACK SHELL OF PLUG バック シェル	4
1	STEEL/UNDER: COPPER PLATING, TOP: Ni PLATING 鋼/下地: 銅めっき, 表面: ニッケルめっき	FRONT SHELL OF PLUG フロント シェル	3
1	POLYESTER OF GLASS FILLED THERMO PLASTIC(UL94V-0) ガラス入り熱可塑性ポリエステル系樹脂 UL94V-0	CAP HSG キャップ ハウジング	2
1	CONTACT(COPPER ALLOY/ UNDER ALL SURFACE: Ni PLATING 1.27μm MIN TOP CONTACT AREA: Au PLATING 0.76μm MIN SOLDERING AREA: Tin PLATING 2μm MIN) HSG(POLYAMIDE OF GLASS FILLED PLASTIC(UL94V-0)) INDUCTOR(TDK SP0203-R10K-PF) コンタクト(銅合金/ 全面: ニッケルめっき下地 1.27μm以上 表面 接点部: 金めっき 0.76μm以上 半田付け部: 錫めっき 2μm以上) ハウジング(ガラス入りポリアミド系樹脂 UL94V-0) インダクタ(TDK製 SP0203-R10K-PF)	SUB PLUG ASSY with INDUCTOR サブ プラグ アッセムリ (インダクタ付)	1
REQUIRED PAR ASSEMBLY	MATERIAL/FINISH 材料/仕上げ	PART NAME 部品名称	ITEM NO.

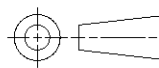
DIMENSIONS: 単位: 概 mm	TOLERANCES UNLESS OTHERWISE SPECIFIED: 一般公差 ±0.3 0 PLC ± 1 PLC ± 2 PLC ± 3 PLC ± 4 PLC ± ANGLES ±	DWN K. RIKU 27OCT2006	 TE Connectivity	NAME 名称 MECHATROLINK II CONNECTOR KIT
		CHK I. HASEGAWA 27OCT2006		
	MATERIAL 材料	APVD I. HASEGAWA 27OCT2006	PRODUCT SPEC 製品規格	RESTRICTED TO
		FINISH 仕上	APPLICATION SPEC 取付適用規格 114-5404	WEIGHT (TRAY IS CONTAINED) 29.9(g)
CUSTOMER DRAWING		SIZE A3	CAGE CODE 00779	DRAWING NO. C=1827525
		SHEET OF		REV C1