

Features

1L0531Y22C0CA204

- § forward current $\leq 30\text{mA}$
- § Wide viewing angle: 15°
- § Operating Temperature $-30\sim 80^\circ\text{C}$
- § Storage temperature $-40\sim 100^\circ\text{C}$
- § Junction Temperature 110°C
- § ROHS and REACH-compliant
- § Lens Color Code : Water Transparent
- § Lead Frame : Ag Plating Iron Alloy
- § Resin(Mold) : Epoxy
- § Chip material: AlGaInP
- § Reverse Voltage: 5V
- § Pulsed Forward Current: 100mA
- § Duty 1/10 Pulse Width 0.1ms

Product Identification Code

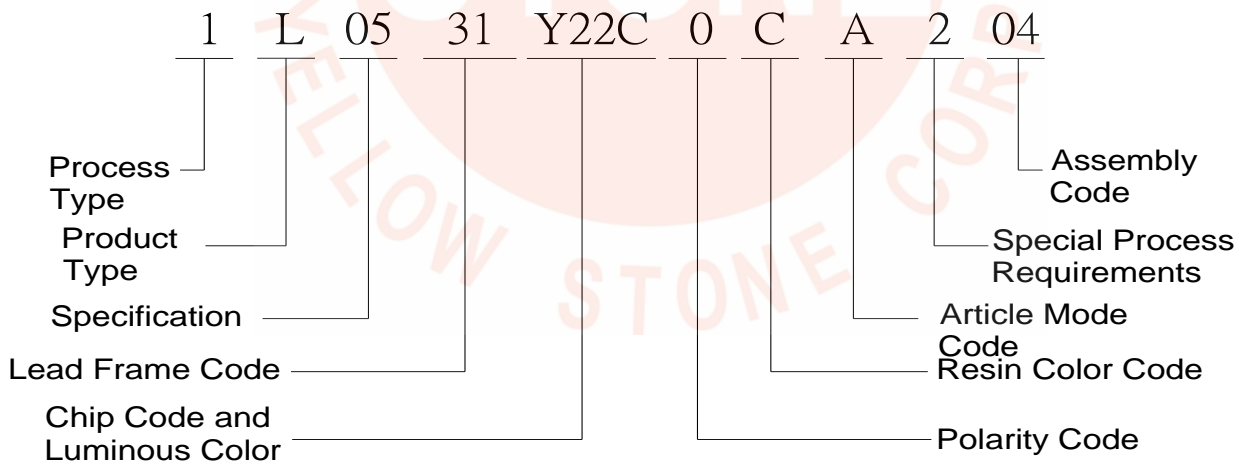

Directive Characteristics ($T_a=25^\circ\text{C}$)

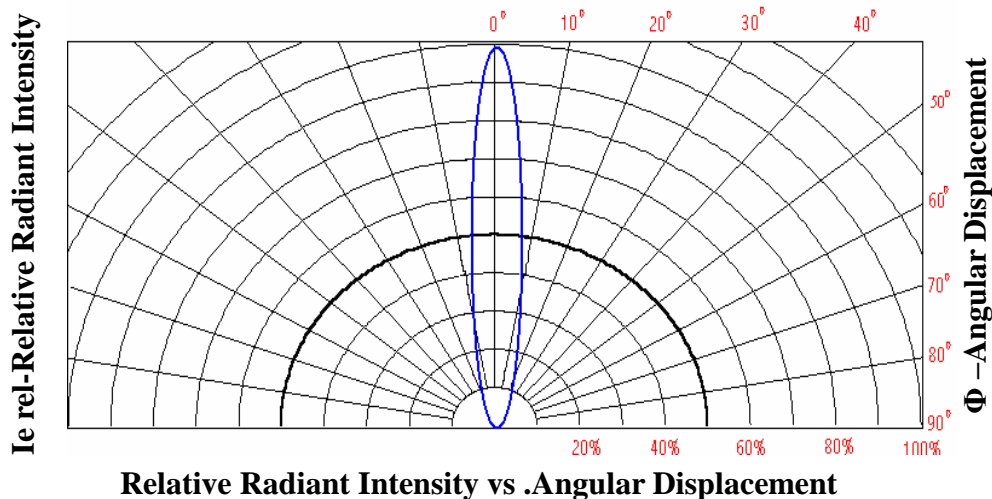

Electrical-Optical Characteristics (Ta=25°C) 1L0531Y22C0CA204

Parameter	Symbol	Value			Unit	Test condition
		Min.	Typ.	Max.		
Forward Voltage	Vf	1.7	2.1	2.7	V	If=20mA
Luminous intensity	Iv	1700	3200		mcd	If=20mA
Wavelength	λd	585		597	nm	If=20mA
Reverse Current	Ir			10	μA	Vr=5V
Viewing angle	2 θ 1/2		15		Deg	If=20mA

1.Luminous intensity (IV) $\pm 10\%$, Forward Voltage (VF) $\pm 0.1V$, Wavelength (λd) $\pm 0.5nm$

2.IS standard testing

Range of bins

Bin	Bin0	Bin1	Bin2	Bin3	Bin4	Bin5	Bin6
IV	1-3	3-6	6-9	9-13	13-20	20-30	30-45
Bin	Bin7	Bin8	Bin9	Bin10	Bin11	Bin12	Bin13
IV	45-70	70-90	90-120	120-160	160-210	210-270	270-350
Bin	Bin14	Bin15	Bin16	Bin17	Bin18	Bin19	Bin20
IV	350-460	460-600	600-780	780-1000	1000-1300	1300-1700	1700-2200
Bin	Bin21	Bin22	Bin23	Bin24	Bin25	Bin26	Bin27
IV	2200-2800	2800-3700	3700-4900	4900-6300	6300-8200	8200-10600	10600-13800
Bin	Bin28	Bin29	Bin30	Bin31	Bin32	Bin33	
IV	13800-18000	18000-23400	23400-30400	30400-39500	39500-51400	51400-66800	
Bin	C	D	E	F			
λd	585-588	588-591	591-594	594-597			

****IV Unit: mcd. λd Unit: nm**

Optical Characteristics

1L0531Y22C0CA204

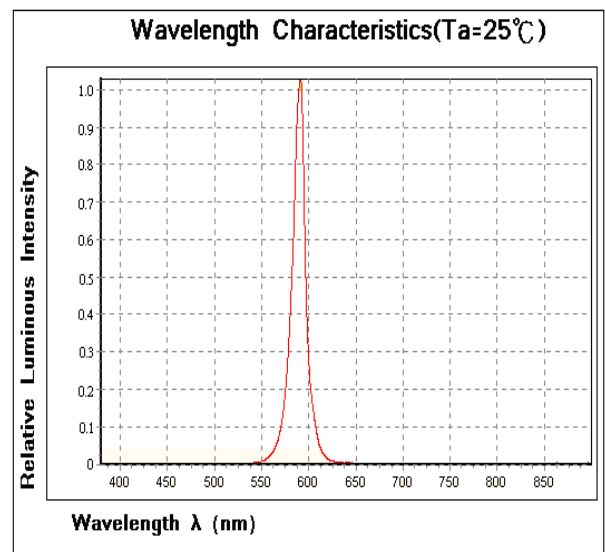
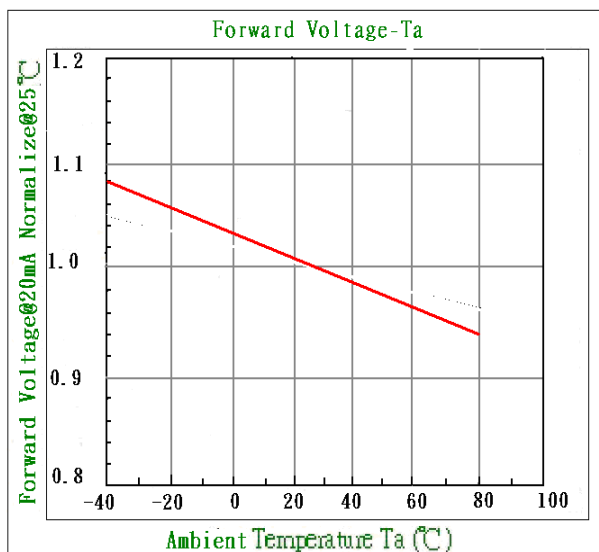
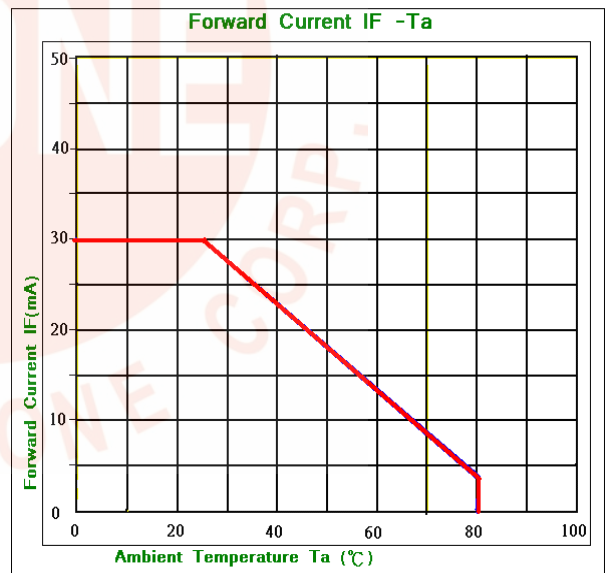
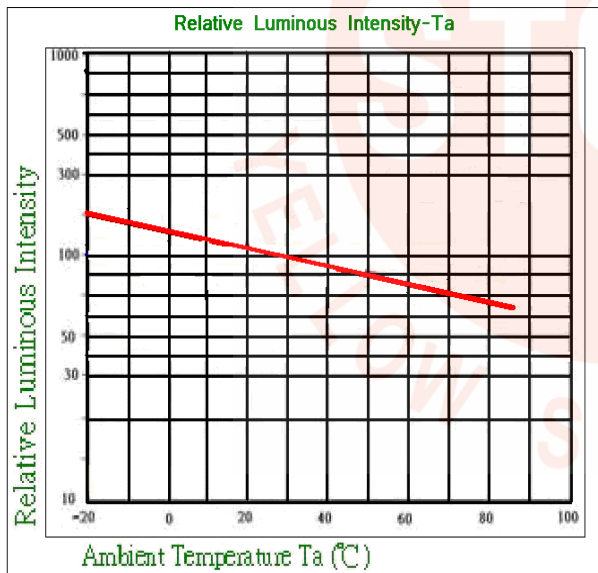
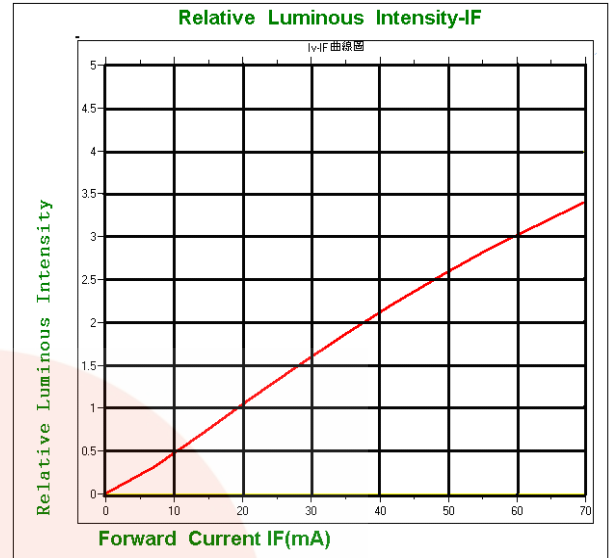
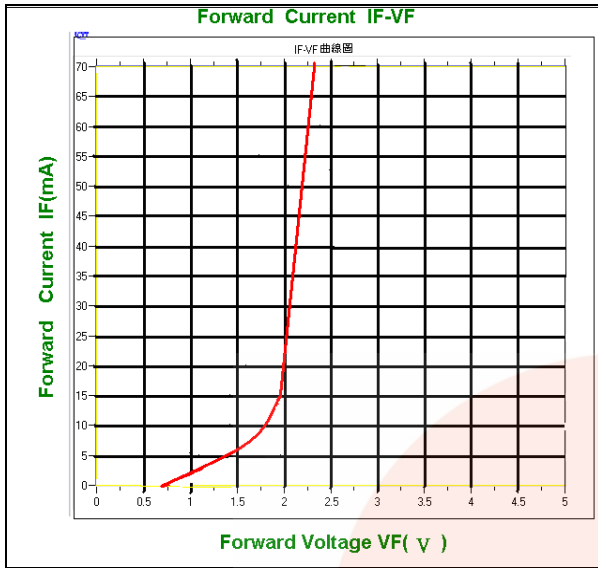

Outline Dimensions

1L0531Y22C0CA204

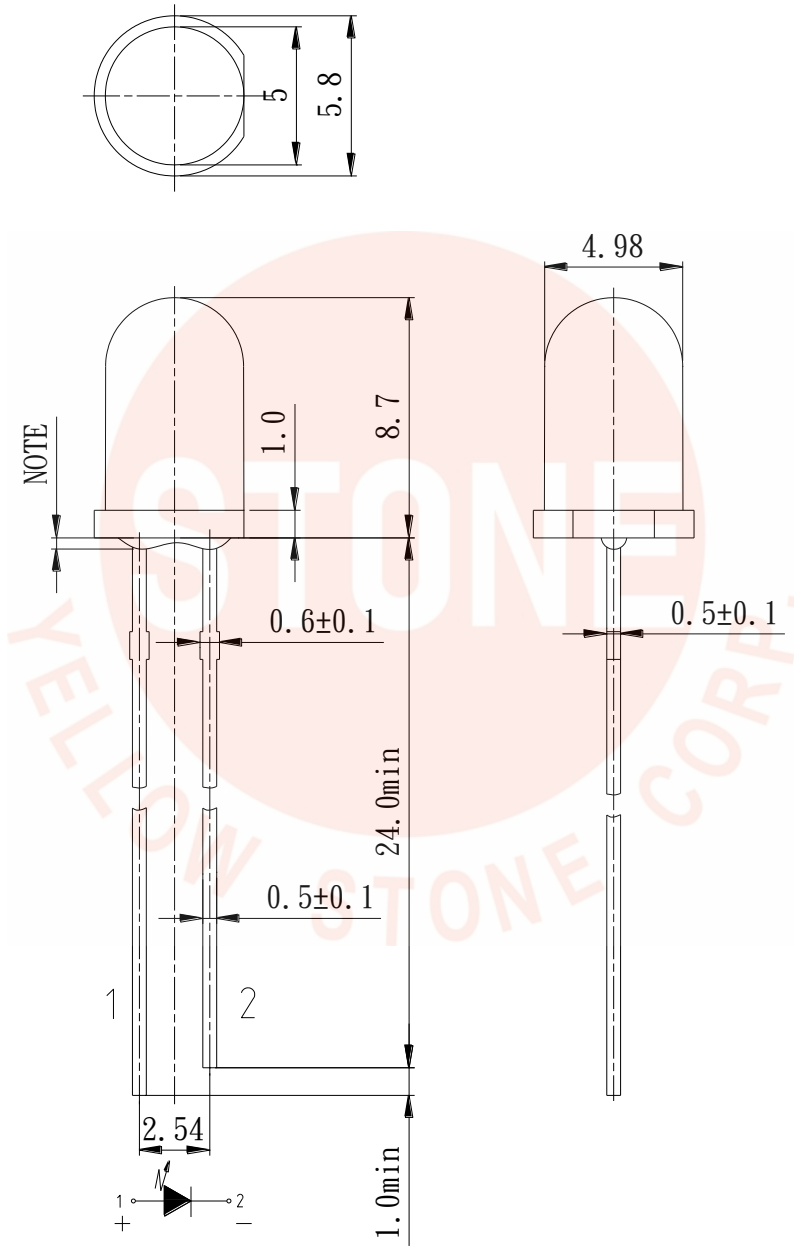

單位 (Units)	圖面未注差 (Encapsulation tolerance)	膠體外觀公差 (Encapsulation tolerance)	膠體伸出尺寸 (NOTE3) (Dimensions of protruded resin flange)
mm	±0.3	±0.25	Max 1.0

LED Usage and Handling Instructions-1 1L0531Y22C0CA204

Dear valued clients:

Thank you for choose our LED products. LEDs are delicate semiconductor product that should be handle according to the below instructions.

A. Storage:

1. LEDs should be stored in an environment with ambient temperature of $23 \pm 5^{\circ}\text{C}$ and relative humidity of 40 ~ 70 %.
2. LEDs should be used within three months of being taken out of their original packages to avoid lead frame rusting.

B. Cleaning:

1. Do not use any unidentified chemical to clean LEDs, it could damage or crack the LED epoxy surface. If necessary, soak LED in alcohol for a time not exceeding one minute in normal temperature.

C. Lead Frames Shaping & Trimming

1. The shaping should be done underneath the wedge point. No pressure should be exerted to the epoxy shell of the LED during shaping.
2. Bending of the leads should be done at a point at least 4 mm from the base of the LED lens.
3. Shaping of the leads should be done before soldering.
4. Lead trimming should only be done at normal temperature.

D. Soldering

1. When soldering, the soldering iron needs to be at least 2mm away from the epoxy edge. After soldering, allow at least 3 minutes for LEDs to cool back to normal temperature. Do not apply any pressure to the epoxy encapsulation or the lead frame during the soldering process.
2. When reflow soldering or wave soldering, please solder once for less than 5 seconds at a maximum temperature of 260°C . During the soldering process, if the temperature or timing is not controlled within limits, it would cause the epoxy to deform or cause the die or wires within the LED to be damaged.

WAVE SOLDERING PROFILE FOR LEAD FREE PROCESS:

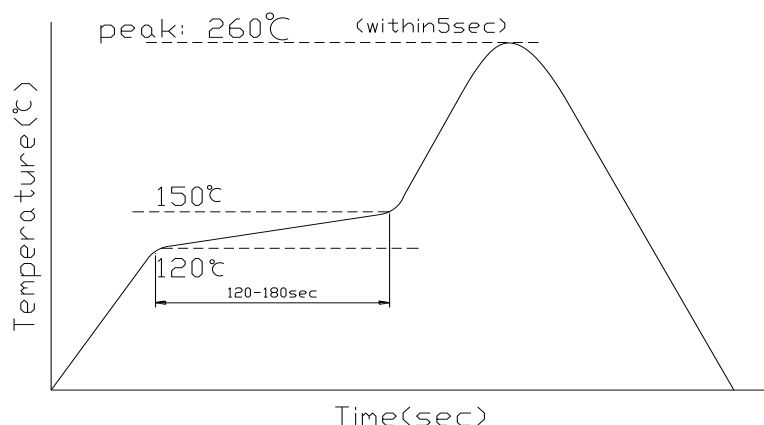

LED Usage and Handling Instructions-2 1L0531Y22C0CA204

3. When using soldering iron, please solder once for less than 5 seconds at a maximum temperature of 300°C. When soldering a row of LED on a PCB, please do not solder both leads of a LED in sequence. (Solder all the positive lead first, then all the negative leads)
4. Do not dip the epoxy encapsulation part of LED into any soldering paste liquid.
5. After soldering, do not adjust the location of the LED anymore.
6. When attaching electronic parts to a PCB with LEDs, the curing time for the whole PCB should be less than 60 seconds, at less than a temperature of 120°C.

E.Installation

7. During the installation process, do not apply any pressure to the leads.
8. Please make sure the installation holes on the PCB matches the leads of the LED.

F.ESD (Electrostatic Discharge)

9. LED is very sensitive to ESD; please make sure during the whole usage and installation process, that no ESD exist to affect the LED. Excessive ESD could damage the LED chip and result in performance degradation.
10. LED can also be damaged by electrical surge, please make sure any driving electrical circuits are equipped with surge protection.
11. During the installation process, please make sure all the equipment and personnel are grounded properly. Make use ESD protection equipment such as anti-static gloves, anti-static wrist bands, anti-static mats, anti-static clothes, anti-static shoes, and anti-static containers.
12. When LED come into contact with low electrical resistance metallic surfaces, the ESD could damage the LED due to sudden discharge of ESD. Please make sure all surfaces that will be in contact with LED are covered with anti-static mats (Surface electrical resistance of $10^6 \sim 10^8 \Omega/\text{sq}$). LED should be placed in anti-static containers and anti-static bags.
13. All soldering irons should be grounded and production environment should make use of ion-blowers.
14. The diameter of the dip holes on PCB should be at least 0.8mm . The distance between the centers of the two dip holes should be within $\pm 0.02\text{mm}$ of the LED lead pitch (standard LED lead pitch is 2.54mm). For special LED lead pitch specifications, the distance should be adjusted accordingly.

LED Usage and Handling Instructions-3 1L0531Y22C0CA204

G.Recommended Usage Guidelines

15. Please only use 20mA (Lamp LED) and 30mA (High Flux LED) of forward current to drive LEDs whether one LED or multiple LEDs are being used.
16. Circuit connections

- i. Serial connection

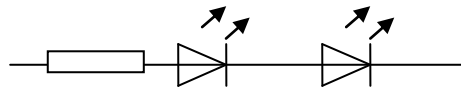

- ii. Parallel connection

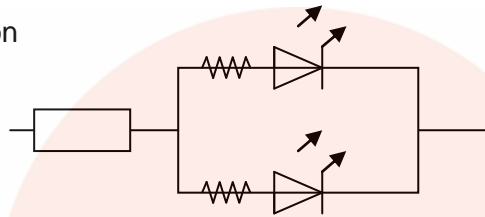

17. Sudden surge could damage the LED interior connections. Please design circuit with care so no sudden voltage surge or current surge will show when turning the circuit on or off.
18. When color or brightness uniformity is required while using multiple LEDs, the LED driver condition is critical. Our company guarantees the uniformity of the LEDs from the same bin when the driver current is 20mA (Lamp LED) and 30mA (High Flux LED)

H.Safety

19. Please comply with government electrical safety code while using the LEDs.
20. Do not look directly into a lit LED; it could damage the eyes after only a few seconds.
21. Do not look directly into powered UV LEDs; it could damage the eyes after only a few seconds. (UV LEDs are mainly used in currency validating machines)

I. Direction:說明:

一、謹致執事者：茲提供敝公司產品之有關詳細規格及圖面資料，敬請辦理測試認定手續。請送返一份附有貴公司簽認之測試認定後之樣品認定書。

We are sending you our specification and drawings for your approval. Please return to us one copy "For Approval" with your approved signatures.

二、符合客戶 HSF 要求

Comply with HSF request of customers