

Datasheet

RS Capacitor Mounting Clip For Use With 50 mm Dia. Capacitors 50mm Nylon

RS Stock 203-5727

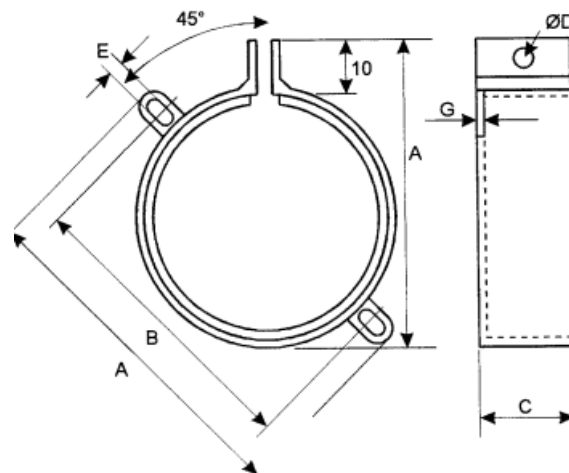

Specifications

Metal clips can cut through the insulating sleeve of the capacitor being mounted and cause problems which cannot occur with an insulating NYLON clip.

The good properties of NYLON are well known and these clips are particularly useful where vibration is involved.

The insulated versions have a 2mm raised mounting at the base eliminating the need for an insulating disc on the capacitor.

RS	Can Ø	A	B	C	D	E	G
203-5676	25	49	37	25	4	4.7	2.5
238-7264	30	54	42.2	25	4	4.7	2.5
203-5698	35	57.5	46	25	4	4.7	2.5
203-5705	40	64	52	25	4	4.7	2.5
203-5711	45	68	56	25	4	4.7	2.5

RS	Can Ø	A	B	C	D	E	F	G
203-5727	50	74	32	25	4	4.7	37	2.5
203-5733	63.5	87	38.5	25	4	4.7	43.5	2.5
203-5755	76	100	45	25	4	4.7	50	2.5
203-5761	90	114	52	25	4	4.7	57	2.5

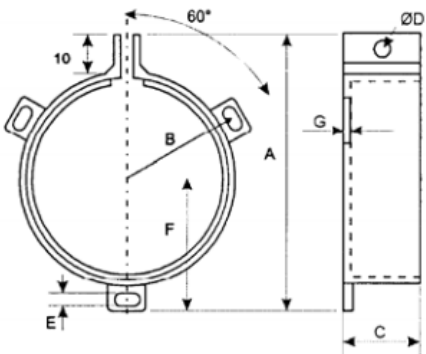

The non insulated versions have a through fitting hole and can thus be used for both surface and central mounting.

'SC' series

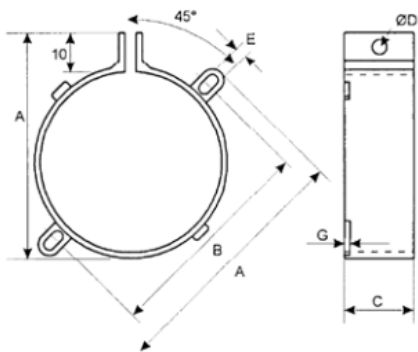

RS	Can Ø	A	B	C	D	E	G
238-7157	25	49	37	25	4	4.7	2.5
238-7179	35	57.5	42.2	25	4	4.7	2.5

'SC' series

RS	Can Ø	A	B	C	D	E	F	G
238-7208	50	74	32	25	4	4.7	37	2.5
238-7214	63.5	87	38.5	25	4	4.7	43.5	2.5
238-7236	76	100	45	25	4	4.7	50	2.5

