

# Built-in Power Supply Photoelectric Sensor

## E3JK <NEW>

### Long-distance Photoelectric Sensor That Supports AC/DC Power Supplies



- Long sensing distance that is approximately 8 times that of our conventional model (for the Through-beam and Diffuse-reflective models). (Through-beam: 40 m, Retro-reflective: 7 m, and Diffuse-reflective: 2.5 m.)
- Improved visibility:
  - A red LED that makes the spot visible.
  - Large indicators that can be seen even from a distance.
- Improved operability. (Enlarged sensitivity adjuster and operation selector)
- Freely selectable power supply input (24 to 240 VDC, 24 to 240 VAC). (Additional types added to the DC type lineup.)
- Models with infrared LEDs are also available.



For the most recent information on models that have been certified for safety standards, refer to your OMRON website.



Refer to the *Safety Precautions* on page 15.

### Applications

Elevator cage detection



Detection of packages jutting out from their storage location

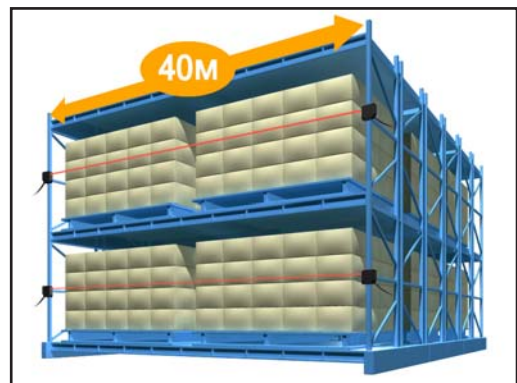

Pallet detection for agricultural produce conveyors

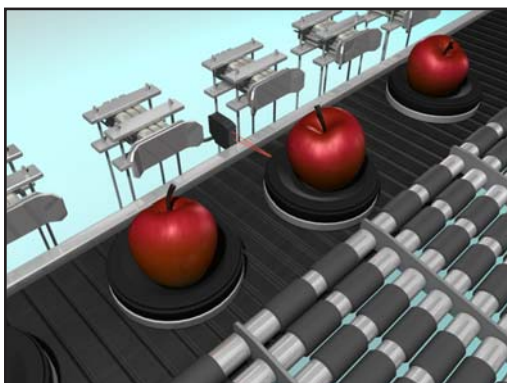

Workpiece detection for woodworking machines

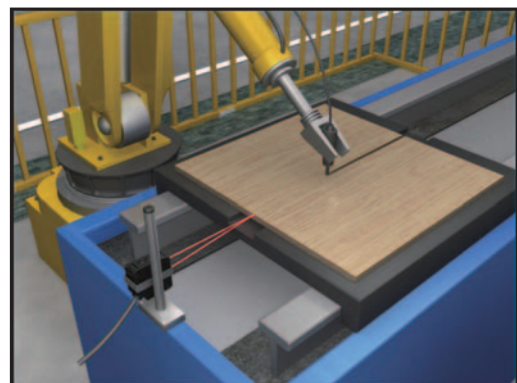











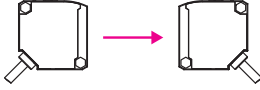

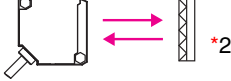

# E3JK

## Ordering Information

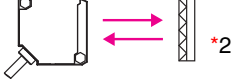
### Sensors

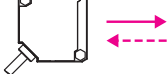
#### Sensors without Brackets or Reflectors

 Red light  Infrared light

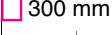











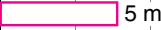
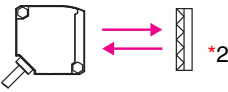

Power supply voltage	Sensing method	Appearance	Sensing distance	Output configuration	Model	
AC/DC power supply selectable type	Through-beam *1 (Emitter + Receiver)		 40 m	Relay	<b>E3JK-TR11 2M</b> Emitter: E3JK-TR11-L 2M Receiver: E3JK-TR11-D 2M	
			 5 m		<b>E3JK-TR12 2M</b> Emitter: E3JK-TR12-L 2M Receiver: E3JK-TR12-D 2M	
			 40 m		<b>E3JK-TR13 2M</b> Emitter: E3JK-TR13-L 2M Receiver: E3JK-TR13-D 2M	
			 5 m		<b>E3JK-TR14 2M</b> Emitter: E3JK-TR14-L 2M Receiver: E3JK-TR14-D 2M	
	Retro-reflective without MSR function		 7 m [100 mm] (*3) (When using E39-R1)		<b>E3JK-RR11 2M</b>	
			 11 m [100 mm] (*3) (When using E39-R2)			
			 7 m [100 mm] (*3) (When using E39-R1)			
			 11 m [100 mm] (*3) (When using E39-R2)			
	Retro-reflective with MSR function		 6 m [100 mm] (*3) (When using E39-R1)			<b>E3JK-RR12 2M</b>
			 10 m [100 mm] (*3) (When using E39-R2)			
	Diffuse-reflective		 2.5 m			<b>E3JK-DR11 2M</b>
			 300 mm			<b>E3JK-DR12 2M</b>
			 2.5 m		<b>E3JK-DR13 2M</b>	
			 300 mm		<b>E3JK-DR14 2M</b>	

\*1. Through-beam Sensors are sold in sets that include both the Emitter and Receiver.

\*2. A Reflector is not included. Purchase a Reflector separately to match the intended use of the Sensor.

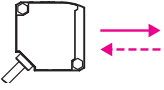
\*3. Values in parentheses indicate the minimum required distances between the Sensors and Reflectors.

 Red light  Infrared light











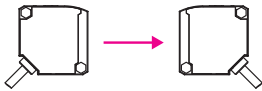

Power supply voltage	Sensing method	Appearance	Sensing distance	Output configuration	Model	
DC	Through-beam *1 (Emitter + Receiver)		 40 m	NPN	<b>E3JK-TN11 2M</b> Emitter: E3JK-TN11-L 2M Receiver: E3JK-TN11-D 2M	
				PNP	<b>E3JK-TP11 2M</b> Emitter: E3JK-TP11-L 2M Receiver: E3JK-TP11-D 2M	
			 5 m	NPN	<b>E3JK-TN12 2M</b> Emitter: E3JK-TN12-L 2M Receiver: E3JK-TN12-D 2M	
				PNP	<b>E3JK-TP12 2M</b> Emitter: E3JK-TP12-L 2M Receiver: E3JK-TP12-D 2M	
			 40 m	NPN	<b>E3JK-TN13 2M</b> Emitter: E3JK-TN13-L 2M Receiver: E3JK-TN13-D 2M	
				PNP	<b>E3JK-TP13 2M</b> Emitter: E3JK-TP13-L 2M Receiver: E3JK-TP13-D 2M	
			 5 m	NPN	<b>E3JK-TN14 2M</b> Emitter: E3JK-TN14-L 2M Receiver: E3JK-TN14-D 2M	
				PNP	<b>E3JK-TP14 2M</b> Emitter: E3JK-TP14-L 2M Receiver: E3JK-TP14-D 2M	
	Retro-reflective without MSR function		 7 m <sup>*3</sup> [100 mm] (When using E39-R1)	NPN	<b>E3JK-RN11 2M</b>	
			 11 m <sup>*3</sup> [100 mm] (When using E39-R2)	PNP	<b>E3JK-RP11 2M</b>	
			 7 m <sup>*3</sup> [100 mm] (When using E39-R1)	NPN	<b>E3JK-RN13 2M</b>	
			 11 m <sup>*3</sup> [100 mm] (When using E39-R2)	PNP	<b>E3JK-RP13 2M</b>	
			Retro-reflective with MSR function	 6 m <sup>*3</sup> [100 mm] (When using E39-R1)	NPN	<b>E3JK-RN12 2M</b>
				 10 m <sup>*3</sup> [100 mm] (When using E39-R2)	PNP	<b>E3JK-RP12 2M</b>
	Diffuse-reflective		 2.5 m	NPN	<b>E3JK-DN11 2M</b>	
				PNP	<b>E3JK-DP11 2M</b>	
			 300 mm	NPN	<b>E3JK-DN12 2M</b>	
				PNP	<b>E3JK-DP12 2M</b>	
			 2.5 m	NPN	<b>E3JK-DN13 2M</b>	
				PNP	<b>E3JK-DP13 2M</b>	
	NPN	<b>E3JK-DN14 2M</b>				
	PNP	<b>E3JK-DP14 2M</b>				

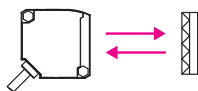
\*1. Through-beam Sensors are sold in sets that include both the Emitter and Receiver.  
 \*2. A Reflector is not included. Purchase a Reflector separately to match the intended use of the Sensor.  
 \*3. Values in parentheses indicate the minimum required distances between the Sensors and Reflectors.

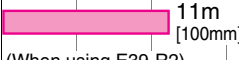
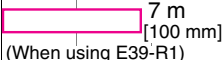
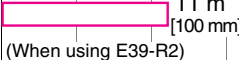
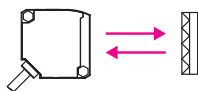
## Sensors

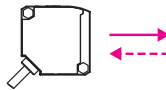
 Red light  Infrared light

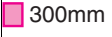
### Sensors with Brackets and Reflectors (The model numbers contain ("-C."))

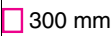
Power supply voltage	Sensing method	Appearance	Sensing distance	Output configuration	Model	
AC/DC power supply selectable type	Through-beam *1 (Emitter + Receiver)		 40m	Relay	<b>E3JK-TR11-C 2M</b> Emitter: E3JK-TR11-L 2M Receiver: E3JK-TR11-D 2M	
			 5m		<b>E3JK-TR12-C 2M</b> Emitter: E3JK-TR12-L 2M Receiver: E3JK-TR12-D 2M	
			 40 m		<b>E3JK-TR13-C 2M</b> Emitter: E3JK-TR13-L 2M Receiver: E3JK-TR13-D 2M	
			 5 m		<b>E3JK-TR14-C 2M</b> Emitter: E3JK-TR14-L 2M Receiver: E3JK-TR14-D 2M	
	Retro-reflective without MSR function		 7m *2 [100mm] (When using E39-R1)		Relay	<b>E3JK-RR11-C 2M</b>
			 11m [100mm] (When using E39-R2)			
			 7 m *2 [100 mm] (When using E39-R1)			
			 11 m [100 mm] (When using E39-R2)			
	Retro-reflective with MSR function		 6m *2 [100mm] (When using E39-R1)		Relay	<b>E3JK-RR12-C 2M</b>
			 10m [100mm] (When using E39-R2)			
	Diffuse-reflective		 2.5m		Relay	<b>E3JK-DR11-C 2M</b>
			 300mm			
			 2.5 m			
			 300 mm			

\*1. Through-beam Sensors are sold in sets that include both the Emitter and Receiver.

\*2. Values in parentheses indicate the minimum required distances between the Sensors and Reflectors.

**Accessories (Order Separately)**

**Reflectors** (A Reflector is required for each Retro-reflective Sensor.) [Refer to *Dimensions* on page 17.]

The E39-R1 is enclosed with Sensors with model numbers that contain “-C.”

Name	Sensing distance (rated value)		Model	Quantity
Reflectors	E3JK-R□11	7 m [100 mm] *	E39-R1	1
	E3JK-R□12	6 m [100 mm] *		
	E3JK-R□13	7 m [100 mm] *		
	E3JK-R□11	9 m [100 mm] *	E39-R1S	1
	E3JK-R□12	7 m [100 mm] *		
	E3JK-R□13	9 m [100 mm] *		
	E3JK-R□11	11 m [100 mm] *	E39-R2	1
	E3JK-R□12	10 m [100 mm] *		
	E3JK-R□13	11 m [100 mm] *		

**Note:** Refer to *Engineering Data* on page 12 for details.

\*Values in parentheses indicate the minimum required distances between the Sensors and Reflectors.

**Mounting Bracket** [Refer to *Dimensions* on page 17.]

A Mounting Bracket is enclosed with Sensors with model numbers that contain “-C.”

Appearance	Model	Quantity
	E39-L40	1

**Note:** 1. When using a Through-beam Sensor, order one Mounting Bracket for the Receiver and one for the Emitter.

2. For details, refer to *Mounting Brackets* on E39-L/E39-S/E39-R which can be accessed from your OMRON website.

# E3JK

## Ratings and Specifications

Sensing method		Through-beam			
Item	Model	E3JK-TR11-□	E3JK-TR12-□	E3JK-TR13-□	E3JK-TR14-□
Sensing distance		40 m	5 m	40 m	5 m
Standard sensing object		Opaque: 17-mm dia. min.			
Differential travel		-			
Directional angle		Both Emitter and Receiver 3° min.			
Light source (wavelength)		Red LED (624 nm)		Infrared LED (850 nm)	
Power supply voltage		24 to 240 VDC ±10%, ripple (p-p): 10% max. 24 to 240 VAC ±10%, 50/60 Hz			
Power consumption	DC	3 W max. (Emitter 1.5 W max. Receiver 1.5 W max.)			
	AC	3 W max. (Emitter 1.5 W max. Receiver 1.5 W max.)			
Control output		Relay output SPDT, 250 VAC, 3 A max. (cosφ= 1), 5 VDC, 10 mA min., Light-ON/Dark-ON selectable			
Protection circuits		-			
Life expectancy (relay output)	Mechanical	50,000,000 times min. (switching frequency: 18,000 times/h)			
	Electrical	100,000 times min. (switching frequency: 1,800 times/h)			
Response time		20 ms max.			
Sensitivity adjustment		One-turn adjuster Receiver (E3JK-TR1□-D) only			
Ambient illumination (Receiver side)		Incandescent lamp: 3,000 lx max., Sunlight: 11,000 lx max.			
Ambient temperature range		Operating: -25°C to 55°C, Storage: -40°C to 70°C (with no icing or condensation)			
Ambient humidity range		Operating: 35% to 85%, Storage: 35% to 95% (with no condensation)			
Insulation resistance		20 MΩ min. at 500 VDC			
Dielectric strength		1,500 VAC, 50/60 Hz for 1 min			
Vibration resistance	Destruction	10 to 55 Hz with a 1.5 mm double amplitude for 2 hours each in X, Y, and Z directions			
	Malfunction	10 to 55 Hz with a 1.5 mm double amplitude for 2 hours each in X, Y, and Z directions			
Shock resistance	Destruction	500 m/s <sup>2</sup> for 3 times each in X, Y, and Z directions			
	Malfunction	100 m/s <sup>2</sup> for 3 times each in X, Y, and Z directions			
Degree of protection		IEC 60529 IP64			
Connection method		Pre-wired (standard length: 2 m)			
Weight (packed state)		Approx. 350 g			
Material	Case	ABS (Acrylonitrile Butadiene Styrene)			
	Lens/Display window	Methacrylic resin			
	Adjuster	POM			
	Cable	PVC			
Bending radius of cable		R18			
Accessories		Instruction manual and Mounting Bracket (E3JK-TR1□-C only)			

Sensing method		Retro-reflective (without MSR function)		Retro-reflective (with MSR function)
Item	Model	E3JK-RR11-□	E3JK-RR13-□	E3JK-RR12-□
<b>Sensing distance</b>		7 m [100 mm]* (When using E39-R1), 11 m [100 mm]* (When using E39-R2)		6 m [100 mm]* (When using E39-R1), 10 m [100 mm]* (When using E39-R2)
<b>Standard sensing object</b>		Opaque: 75-mm dia. min. (When using E39-R1), Opaque: 100-mm dia. min. (When using E39-R2)		
<b>Differential travel</b>		-		
<b>Directional angle</b>		1.5° min.		
<b>Light source (wavelength)</b>		Red LED (624 nm)	Infrared LED (850 nm)	Red LED (624 nm)
<b>Power supply voltage</b>		24 to 240 VDC ±10%, ripple (p-p): 10% max. 24 to 240 VAC ±10%, 50/60 Hz		
<b>Power consumption</b>	<b>DC</b>	2 W max.		
	<b>AC</b>	2 W max.		
<b>Control output</b>		Relay output SPDT, 250 VAC, 3 A max. (cosφ= 1), 5 VDC, 10 mA min., Light-ON/Dark-ON selectable		
<b>Protection circuits</b>		Mutual interference prevention function		
<b>Life expectancy (relay output)</b>	<b>Mechanical</b>	50,000,000 times min. (switching frequency: 18,000 times/h)		
	<b>Electrical</b>	100,000 times min. (switching frequency: 1,800 times/h)		
<b>Response time</b>		20 ms max.		
<b>Sensitivity adjustment</b>		One-turn adjuster		
<b>Ambient illumination (Receiver side)</b>		Incandescent lamp: 3,000 lx max., Sunlight: 11,000 lx max.		
<b>Ambient temperature range</b>		Operating: -25°C to 55°C, Storage: -40°C to 70°C (with no icing or condensation)		
<b>Ambient humidity range</b>		Operating: 35% to 85%, Storage: 35% to 95% (with no condensation)		
<b>Insulation resistance</b>		20 MΩ min. at 500 VDC		
<b>Dielectric strength</b>		1,500 VAC, 50/60 Hz for 1 min		
<b>Vibration resistance</b>	<b>Destruction</b>	10 to 55 Hz with a 1.5 mm double amplitude for 2 hours each in X, Y, and Z directions		
	<b>Malfunction</b>	10 to 55 Hz with a 1.5 mm double amplitude for 2 hours each in X, Y, and Z directions		
<b>Shock resistance</b>	<b>Destruction</b>	500 m/s <sup>2</sup> for 3 times each in X, Y, and Z directions		
	<b>Malfunction</b>	100 m/s <sup>2</sup> for 3 times each in X, Y, and Z directions		
<b>Degree of protection</b>		IEC 60529 IP64		
<b>Connection method</b>		Pre-wired (standard length: 2 m)		
<b>Weight (packed state)</b>		Approx. 180 g		
<b>Material</b>	<b>Case</b>	ABS (Acrylonitrile Butadiene Styrene)		
	<b>Lens/Display window</b>	Methacrylic resin		
	<b>Adjuster</b>	POM		
	<b>Cable</b>	PVC		
<b>Bending radius of cable</b>		R18		
<b>Accessories</b>		Instruction manual, Mounting Bracket (E3JK-RR1□-C only), and Reflector (E3JK-RR1□-C only)		

\*Values in parentheses indicate the minimum required distances between the Sensors and Reflectors.

# E3JK

Sensing method		Diffuse-reflective			
Item	Model	E3JK-DR11-□	E3JK-DR12-□	E3JK-DR13-□	E3JK-DR14-□
Sensing distance		White paper (300 × 300 mm): 2.5 m	White paper (100 × 100 mm): 300 mm	White paper (300 × 300 mm): 2.5 m	White paper (100 × 100 mm): 300 mm
Standard sensing object		-			
Differential travel		20% max. of sensing distance			
Directional angle		-			
Light source (wavelength)		Red LED (624 nm)		Infrared LED (850 nm)	
Power supply voltage		24 to 240 VDC ±10%, ripple (p-p): 10% max. 24 to 240 VAC ±10%, 50/60 Hz			
Power consumption	DC	2 W max.			
	AC	2 W max.			
Control output		Relay output SPDT, 250 VAC, 3 A max. (cosφ= 1), 5 VDC, 10 mA min., Light-ON/Dark-ON selectable			
Protection circuits		Mutual interference prevention function			
Life expectancy (relay output)	Mechanical	50,000,000 times min. (switching frequency: 18,000 times/h)			
	Electrical	100,000 times min. (switching frequency: 1,800 times/h)			
Response time		20 ms max.			
Sensitivity adjustment		One-turn adjuster			
Ambient illumination (Receiver side)		Incandescent lamp: 3,000 lx max., Sunlight: 11,000 lx max.			
Ambient temperature range		Operating: -25°C to 55°C, Storage: -40°C to 70°C (with no icing or condensation)			
Ambient humidity range		Operating: 35% to 85%, Storage: 35% to 95% (with no condensation)			
Insulation resistance		20 MΩ min. at 500 VDC			
Dielectric strength		1,500 VAC, 50/60 Hz for 1 min			
Vibration resistance	Destruction	10 to 55 Hz with a 1.5 mm double amplitude for 2 hours each in X, Y, and Z directions			
	Malfunction	10 to 55 Hz with a 1.5 mm double amplitude for 2 hours each in X, Y, and Z directions			
Shock resistance	Destruction	500 m/s <sup>2</sup> for 3 times each in X, Y, and Z directions			
	Malfunction	100 m/s <sup>2</sup> for 3 times each in X, Y, and Z directions			
Degree of protection		IEC 60529 IP64			
Connection method		Pre-wired (standard length: 2 m)			
Weight (packed state)		Approx. 180 g			
Material	Case	ABS (Acrylonitrile Butadiene Styrene)			
	Lens/Display window	Methacrylic resin			
	Adjuster	POM			
	Cable	PVC			
Bending radius of cable		R18			
Accessories		Instruction manual and Mounting Bracket (E3JK-DR1□-C only)			



Item	Sensing method		Through-beam			
	Model	NPN output	E3JK-TN11	E3JK-TN12	E3JK-TN13	E3JK-TN14
		PNP output	E3JK-TP11	E3JK-TP12	E3JK-TP13	E3JK-TP14
Sensing distance			40 m	5 m	40 m	5 m
Standard sensing object		Opaque: 17-mm dia. min.				
Differential travel		-				
Directional angle		Both Emitter and Receiver 3° min.				
Light source (wavelength)		Red LED (624 nm)			Infrared LED (850 nm)	
Power supply voltage		10 to 30 VDC, including ripple (p-p): 10%				
Power consumption	DC	40 mA max. (Emitter 25 mA max. Receiver 15 mA max.)				
	AC	-				
Control output		Load power supply voltage: 30 V max., Load current: 100 mA max., Residual voltage: 3 V max., open-collector output (NPN/PNP output depending on model), Light-ON/Dark-ON selectable				
Protection circuits		Power supply reverse polarity protection, Output short-circuit protection, and Output reverse polarity protection				
Life expectancy (relay output)	Mechanical	-				
	Electrical	-				
Response time		1 ms max.				
Sensitivity adjustment		One-turn adjuster Receiver (E3JK-T□□□-D) only				
Ambient illumination (Receiver side)		Incandescent lamp: 3,000 lx max., Sunlight: 11,000 lx max.				
Ambient temperature range		Operating: -25°C to 55°C, Storage: -40°C to 70°C (with no icing or condensation)				
Ambient humidity range		Operating: 35% to 85%, Storage: 35% to 95% (with no condensation)				
Insulation resistance		20 MΩ min. at 500 VDC				
Dielectric strength		1,500 VAC, 50/60 Hz for 1 min				
Vibration resistance	Destruction	10 to 55 Hz with a 1.5 mm double amplitude for 2 hours each in X, Y, and Z directions				
	Malfunction	10 to 55 Hz with a 1.5 mm double amplitude for 2 hours each in X, Y, and Z directions				
Shock resistance	Destruction	500 m/s <sup>2</sup> for 3 times each in X, Y, and Z directions				
	Malfunction	500 m/s <sup>2</sup> for 3 times each in X, Y, and Z directions				
Degree of protection		IEC 60529 IP64				
Connection method		Pre-wired (standard length: 2 m)				
Weight (packed state)		Approx. 300 g				
Material	Case	ABS (Acrylonitrile Butadiene Styrene)				
	Lens/Display window	Methacrylic resin				
	Adjuster	POM				
	Cable	PVC				
Bending radius of cable		R18				
Accessories		Instruction manual				

# E3JK

Sensing method		Retro-reflective (without MSR function)		Retro-reflective (with MSR function)
Item	Model	E3JK-RN11	E3JK-RN13	E3JK-RN12
	NPN output			
	PNP output	E3JK-RP11	E3JK-RP13	E3JK-RP12
<b>Sensing distance</b>		7 m [100 mm]* (When using E39-R1), 11 m [100 mm]* (When using E39-R2)		6 m [100 mm]* (When using E39-R1), 10 m [100 mm]* (When using E39-R2)
<b>Standard sensing object</b>		Opaque: 75-mm dia. min.		
<b>Differential travel</b>		-		
<b>Directional angle</b>		1.5° min.		
<b>Light source (wavelength)</b>		Red LED (624 nm)	Infrared LED (850 nm)	Red LED (624 nm)
<b>Power supply voltage</b>		10 to 30 VDC, including ripple (p-p): 10%		
<b>Power consumption</b>	DC	30 mA max.		
	AC	-		
<b>Control output</b>		Load power supply voltage: 30 V max., Load current: 100 mA max., Residual voltage: 3 V max., open-collector output (NPN/PNP output depending on model), Light-ON/Dark-ON selectable		
<b>Protection circuits</b>		Power supply reverse polarity protection, Output short-circuit protection, Mutual interference prevention function, and Output reverse polarity protection		
<b>Life expectancy (relay output)</b>	Mechanical	-		
	Electrical	-		
<b>Response time</b>		1 ms max.		
<b>Sensitivity adjustment</b>		One-turn adjuster		
<b>Ambient illumination (Receiver side)</b>		Incandescent lamp: 3,000 lx max., Sunlight: 11,000 lx max.		
<b>Ambient temperature range</b>		Operating: -25°C to 55°C, Storage: -40°C to 70°C (with no icing or condensation)		
<b>Ambient humidity range</b>		Operating: 35% to 85%, Storage: 35% to 95% (with no condensation)		
<b>Insulation resistance</b>		20 MΩ min. at 500 VDC		
<b>Dielectric strength</b>		1,500 VAC, 50/60 Hz for 1 min		
<b>Vibration resistance</b>	Destruction	10 to 55 Hz with a 1.5 mm double amplitude for 2 hours each in X, Y, and Z directions		
	Malfunction	10 to 55 Hz with a 1.5 mm double amplitude for 2 hours each in X, Y, and Z directions		
<b>Shock resistance</b>	Destruction	500 m/s <sup>2</sup> for 3 times each in X, Y, and Z directions		
	Malfunction	500 m/s <sup>2</sup> for 3 times each in X, Y, and Z directions		
<b>Degree of protection</b>		IEC 60529 IP64		
<b>Connection method</b>		Pre-wired (standard length: 2 m)		
<b>Weight (packed state)</b>		Approx. 160 g		
<b>Material</b>	Case	ABS (Acrylonitrile Butadiene Styrene)		
	Lens/Display window	Methacrylic resin		
	Adjuster	POM		
	Cable	PVC		
<b>Bending radius of cable</b>		R18		
<b>Accessories</b>		Instruction manual		

\*Values in parentheses indicate the minimum required distances between the Sensors and Reflectors.

Model		Sensing method	Diffuse-reflective			
			NPN output	E3JK-DN11	E3JK-DN12	E3JK-DN13
Item	PNP output		E3JK-DP11	E3JK-DP12	E3JK-DP13	E3JK-DP14
	Sensing distance		White paper (300 × 300 mm): 2.5 m	White paper (100 × 100 mm): 300 mm	White paper (300 × 300 mm): 2.5 m	White paper (100 × 100 mm): 300 mm
Standard sensing object		-				
Differential travel		20% max. of sensing distance				
Directional angle		-				
Light source (wavelength)		Red LED (624 nm)			Infrared LED (850 nm)	
Power supply voltage		10 to 30 VDC, including ripple (p-p): 10%				
Power consumption	DC	30 mA max.				
	AC	-				
Control output		Load power supply voltage: 30 V max., Load current: 100 mA max., Residual voltage: 3 V max., open-collector output (NPN/PNP output depending on model), Light-ON/Dark-ON selectable				
Protection circuits		Power supply reverse polarity protection, Output short-circuit protection, Mutual interference prevention function, and Output reverse polarity protection				
Life expectancy (relay output)	Mechanical	-				
	Electrical	-				
Response time		1 ms max.				
Sensitivity adjustment		One-turn adjuster				
Ambient illumination (Receiver side)		Incandescent lamp: 3,000 lx max., Sunlight: 11,000 lx max.				
Ambient temperature range		Operating: -25°C to 55°C, Storage: -40°C to 70°C (with no icing or condensation)				
Ambient humidity range		Operating: 35% to 85%, Storage: 35% to 95% (with no condensation)				
Insulation resistance		20 MΩ min. at 500 VDC				
Dielectric strength		1,500 VAC, 50/60 Hz for 1 min				
Vibration resistance	Destruction	10 to 55 Hz with a 1.5 mm double amplitude for 2 hours each in X, Y, and Z directions				
	Malfunction	10 to 55 Hz with a 1.5 mm double amplitude for 2 hours each in X, Y, and Z directions				
Shock resistance	Destruction	500 m/s <sup>2</sup> for 3 times each in X, Y, and Z directions				
	Malfunction	500 m/s <sup>2</sup> for 3 times each in X, Y, and Z directions				
Degree of protection		IEC 60529 IP64				
Connection method		Pre-wired (standard length: 2 m)				
Weight (packed state)		Approx. 160 g				
Material	Case	ABS (Acrylonitrile Butadiene Styrene)				
	Lens/Display window	Methacrylic resin				
	Adjuster	POM				
	Cable	PVC				
Bending radius of cable		R18				
Accessories		Instruction manual				

# E3JK

## Engineering Data (Reference Value)

### Parallel Operating Range

#### Through-beam

##### E3JK-T□11/T□13

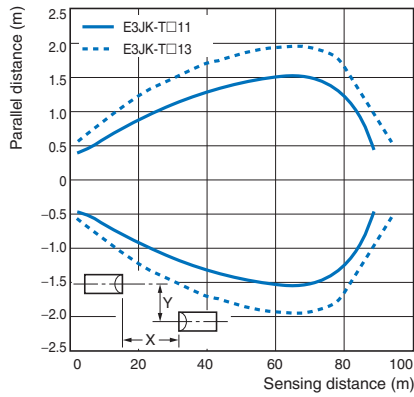

##### E3JK-T□12/T□14

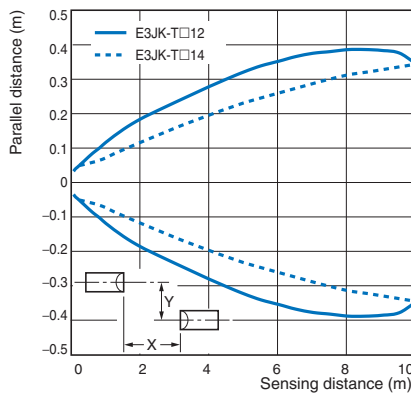

#### Retro-reflective

##### E3JK-R□□1+E39-R1/

##### E3JK-R□□3+E39-R1

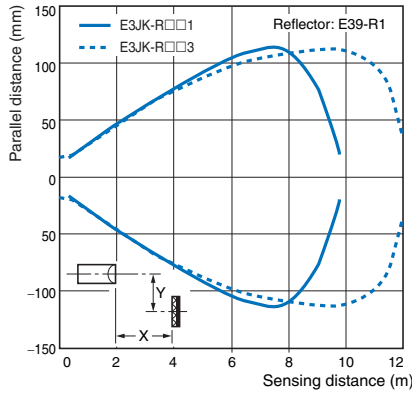

##### E3JK-R□□1+E39-R1S/

##### E3JK-R□□3+E39-R1S

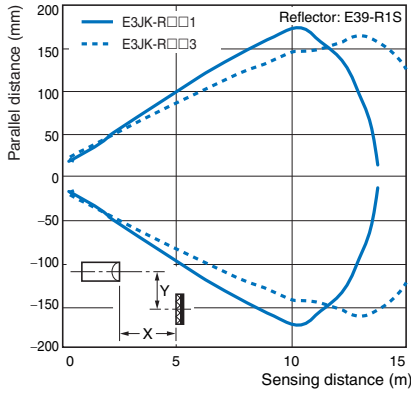

##### E3JK-R□□1+E39-R2/

##### E3JK-R□□3+E39-R2

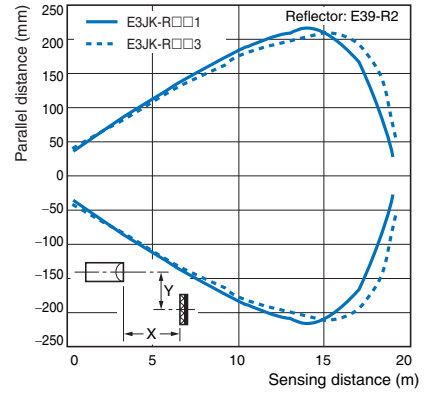

##### E3JK-R□□2+E39-R1

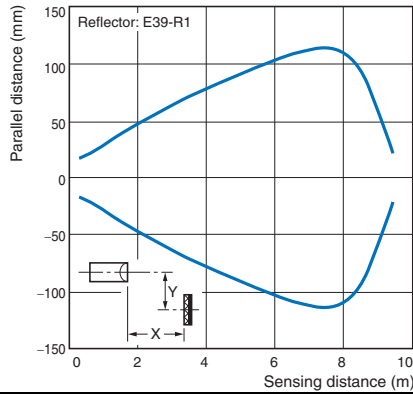

##### E3JK-R□□2+E39-R1S

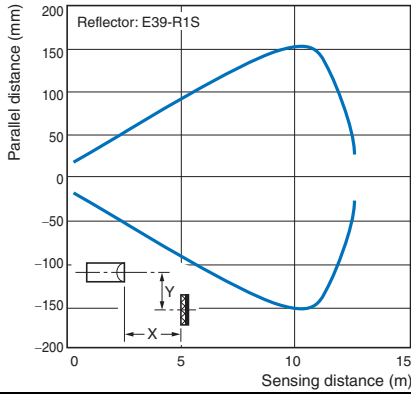

##### E3JK-R□□2+E39-R2

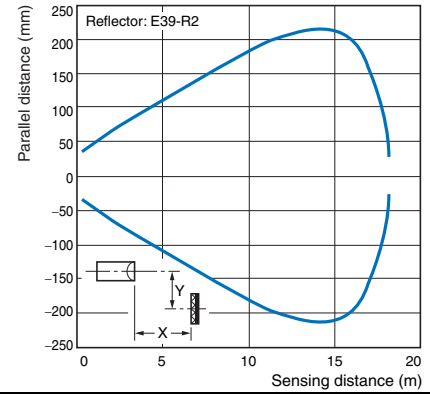

### Operating Range

#### Diffuse-reflective

##### E3JK-D□□1/D□□3

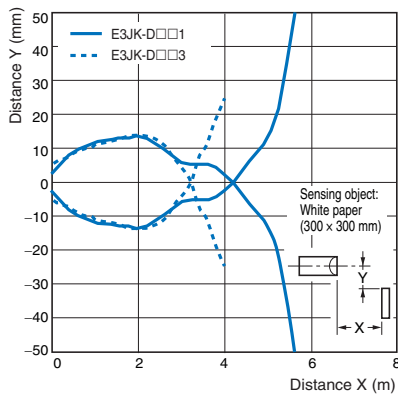

##### E3JK-D□□2/D□□4

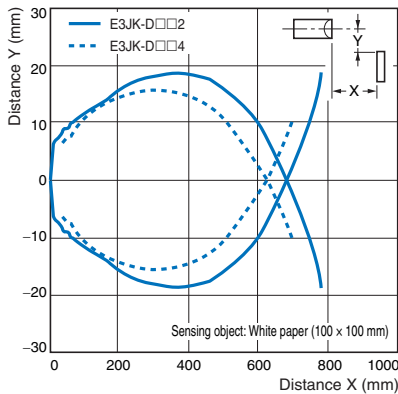

Excess Gain Ratio vs. Set Distance

Through-beam

E3JK-T□11/T□13

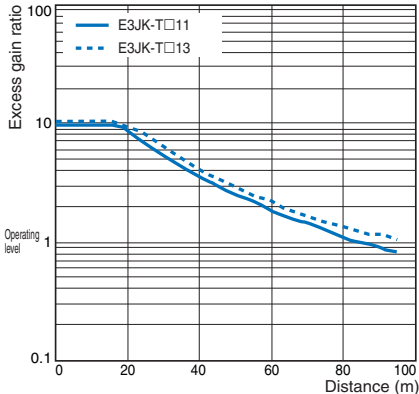

E3JK-T□12/T□14

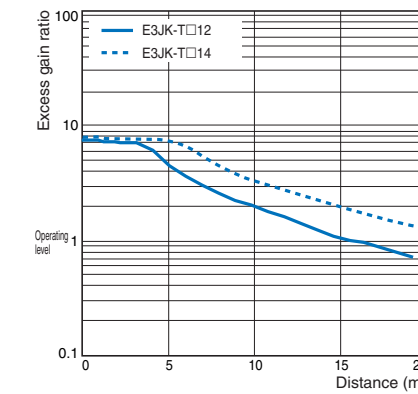

Retro-reflective

E3JK-R□□1+E39-R1/  
E3JK-R□□3+E39-R1

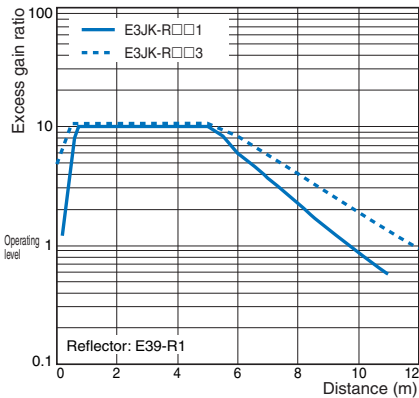

E3JK-R□□1+E39-R1S/  
E3JK-R□□3+E39-R1S

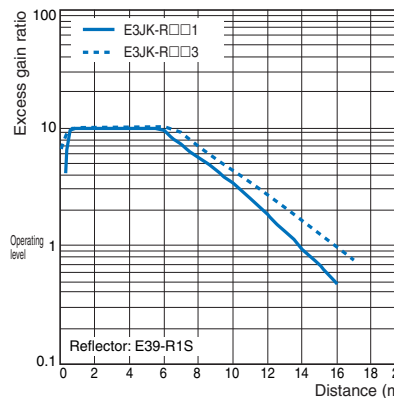

E3JK-R□□1+E39-R2/  
E3JK-R□□3+E39-R2

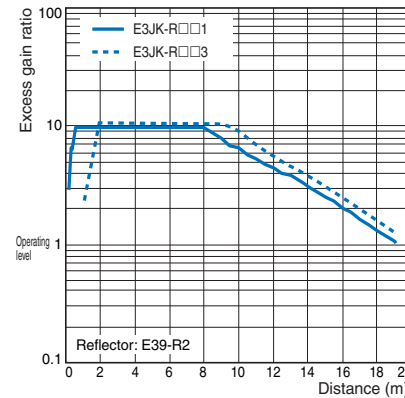

E3JK-R□□2+E39-R1

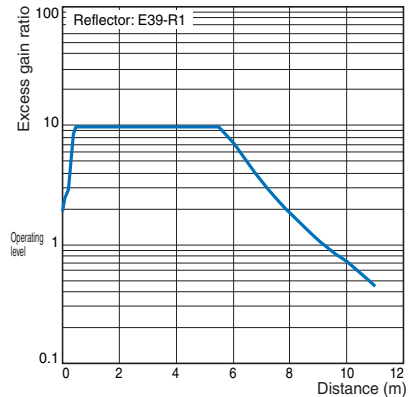

E3JK-R□□2+E39-R1S

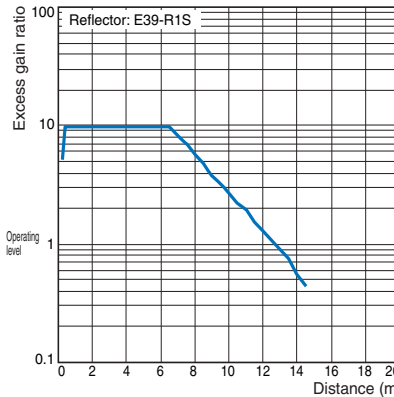

E3JK-R□□2+E39-R2

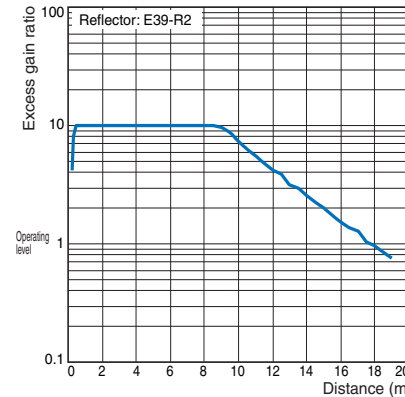

Diffuse-reflective

E3JK-D□□1/D□□3

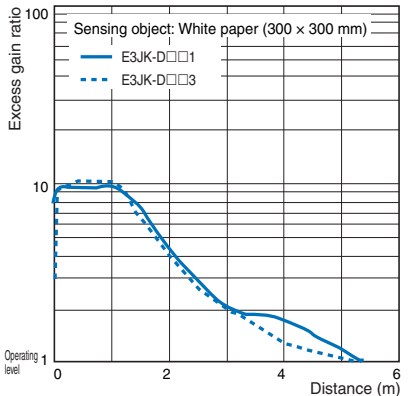

E3JK-D□□2/D□□4

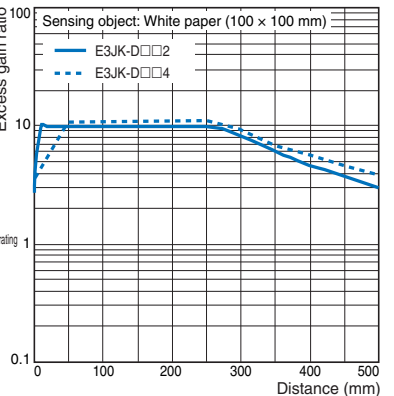

# E3JK

## I/O Circuit Diagrams

### Relay Output Models

Model	Timing chart		Output circuit
	Light-ON	Dark-ON	
E3JK-TR11-L * E3JK-TR12-L * E3JK-TR13-L * E3JK-TR14-L *	/		
E3JK-TR11-D * E3JK-TR12-D * E3JK-TR13-D * E3JK-TR14-D * E3JK-RR11 E3JK-RR12 E3JK-RR13 E3JK-DR11 E3JK-DR12 E3JK-DR13 E3JK-DR14			

### DC SSR Output Models

Model	Timing chart		Output circuit
	Light-ON	Dark-ON	
E3JK-TN11-L * E3JK-TP11-L * E3JK-TN12-L * E3JK-TP12-L * E3JK-TN13-L * E3JK-TP13-L * E3JK-TN14-L * E3JK-TP14-L *	/		
E3JK-TN11-D * E3JK-TN12-D * E3JK-TN13-D * E3JK-TN14-D * E3JK-RN11 E3JK-RN12 E3JK-RN13 E3JK-DN11 E3JK-DN12 E3JK-DN13 E3JK-DN14			
E3JK-TP11-D * E3JK-TP12-D * E3JK-TP13-D * E3JK-TP14-D * E3JK-RP11 E3JK-RP12 E3JK-RP13 E3JK-DP11 E3JK-DP12 E3JK-DP13 E3JK-DP14			

**Note:** Connect the brown cable to any polarity and the blue cable to the power supply because there is no polarity on the Emitter side.

\*For the Through-beam Sensor, the Emitter is listed as E3JK-T□11-L, E3JK-T□12-L and the Receiver is listed as E3JK-T□11-D, E3JK-T□12-D in the table. Confirm the models to order in "Ordering Information."

## Safety Precautions

Refer to *Warranty and Limitations of Liability*.

### WARNING

This product is not designed or rated for ensuring safety of persons either directly or indirectly.



Do not use it for such purposes.

### Caution

Do not wire the product incorrectly.

Do not use this product with a damaged case or cable.



Do not disassemble, repair, or modify this product.

Doing so may lead to explosion, fire, or product failure.



### Precautions for Safe Use

The following precautions must be observed to ensure safe operation of the Sensor.

1. Do not use the Sensor in environments subject to flammable, explosive or corrosive gases.
2. Do not use this product in an environment in which oil or chemicals are present.
3. Do not use this product under water, in the rain, or outdoors.
4. Do not use this product under conditions that exceed or in an environment that exceeds the ratings.
5. When using an AC power supply, do not use a power supply that includes high frequencies (such as an inverter).
6. Do not use this product in a location subject to direct sunlight.
7. Do not use this product in a location in which the product will be subject to direct vibrations or impacts.
8. Do not use thinner, alcohol, or other organic solvents with this product.
9. When disposing of the Sensor, treat it as industrial waste.

### Precautions for Correct Use

- If the product is wired to high-voltage power lines and power lines in the same pipe or the same duct, the product may malfunction or be damaged due to induction. Therefore, in principle, perform these two types of wiring separately or use shielded cords.
- Do not apply excessive force to the cables.
- When using a commercially available switching regulator, be sure to install an FG (frame ground terminal).
- The time between the product being turned ON and sensing being possible is 100 ms, so wait at least 100 ms after turning the product ON before using it. If the load and the product are connected to different power supplies, be sure to turn the product ON first.
- An output pulse may be generated when the product is turned OFF, so we recommend turning the load or the load line OFF first.

# E3JK

## Dimensions

(Unit: mm)

Tolerance class IT16 applies to dimensions in this datasheet unless otherwise specified.

### Sensors

#### Through-beam E3JK-T□1□

#### <Emitter> E3JK-T□1□-L

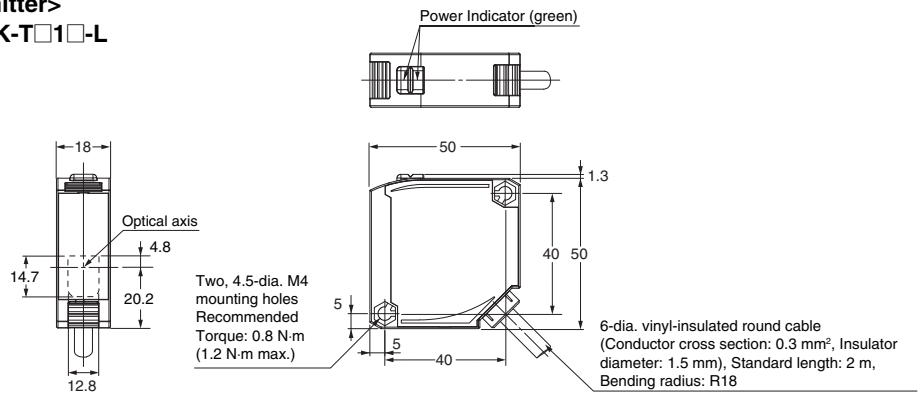

#### <Receiver> E3JK-T□1□-D

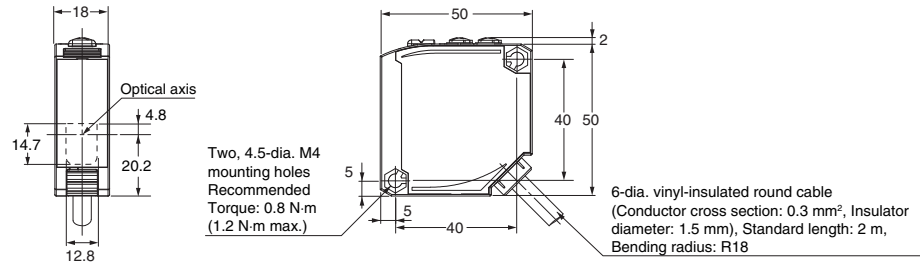
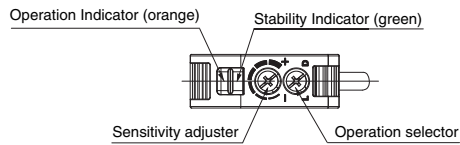

#### Retro-reflective/ Diffuse-reflective

#### E3JK-R□1□ E3JK-D□1□

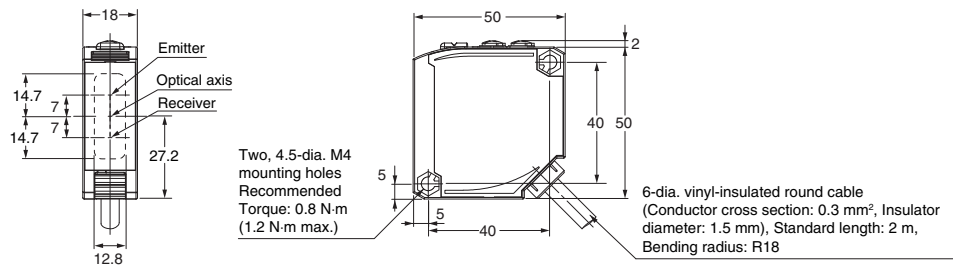
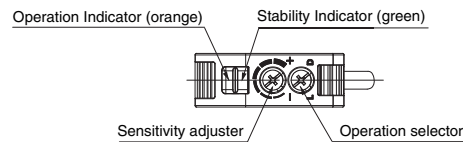



Accessories

Mounting Bracket (Order separately)

Mounting Bracket  
E39-L40

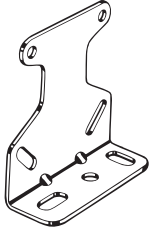

Material: Iron

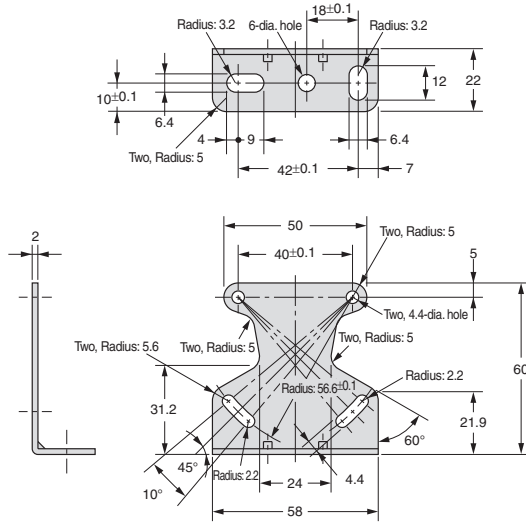

With Mounting Bracket Attached

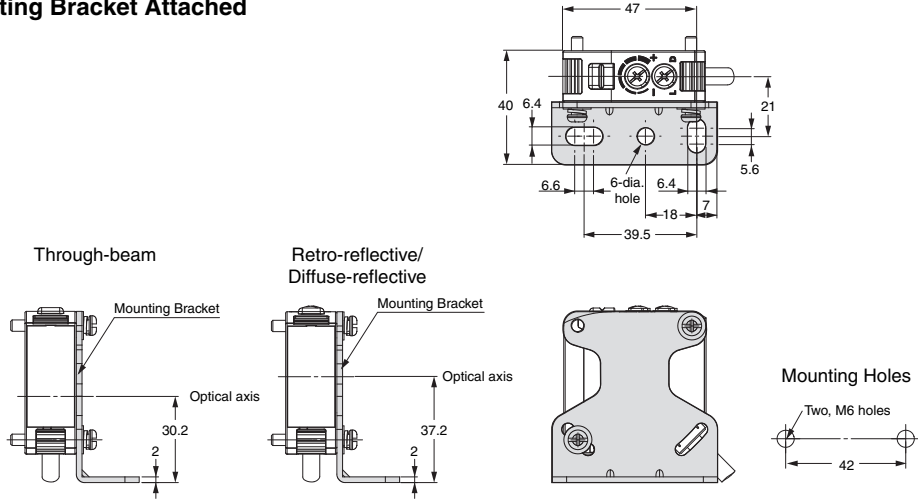

Reflector (Order separately)

E39-R1  
E39-R1S



Material:  
Reflective surface: acrylic  
Rear surface: ABS

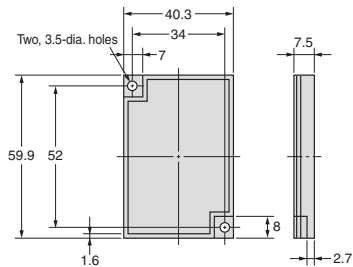

E39-R2

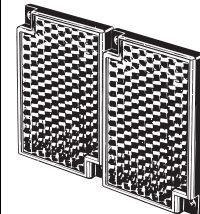

Material:  
Reflective surface: acrylic  
Rear surface: ABS

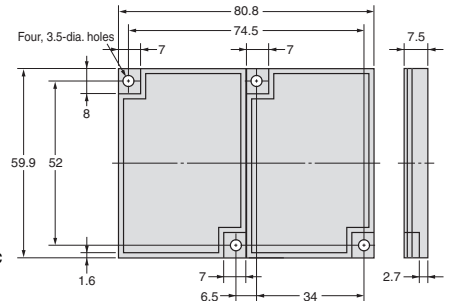



# Terms and Conditions Agreement

## Read and understand this catalog.

Please read and understand this catalog before purchasing the products. Please consult your OMRON representative if you have any questions or comments.

## Warranties.

- (a) Exclusive Warranty. Omron's exclusive warranty is that the Products will be free from defects in materials and workmanship for a period of twelve months from the date of sale by Omron (or such other period expressed in writing by Omron). Omron disclaims all other warranties, express or implied.
- (b) Limitations. OMRON MAKES NO WARRANTY OR REPRESENTATION, EXPRESS OR IMPLIED, ABOUT NON-INFRINGEMENT, MERCHANTABILITY OR FITNESS FOR A PARTICULAR PURPOSE OF THE PRODUCTS. BUYER ACKNOWLEDGES THAT IT ALONE HAS DETERMINED THAT THE PRODUCTS WILL SUITABLY MEET THE REQUIREMENTS OF THEIR INTENDED USE.

Omron further disclaims all warranties and responsibility of any type for claims or expenses based on infringement by the Products or otherwise of any intellectual property right. (c) Buyer Remedy. Omron's sole obligation hereunder shall be, at Omron's election, to (i) replace (in the form originally shipped with Buyer responsible for labor charges for removal or replacement thereof) the non-complying Product, (ii) repair the non-complying Product, or (iii) repay or credit Buyer an amount equal to the purchase price of the non-complying Product; provided that in no event shall Omron be responsible for warranty, repair, indemnity or any other claims or expenses regarding the Products unless Omron's analysis confirms that the Products were properly handled, stored, installed and maintained and not subject to contamination, abuse, misuse or inappropriate modification. Return of any Products by Buyer must be approved in writing by Omron before shipment. Omron Companies shall not be liable for the suitability or unsuitability or the results from the use of Products in combination with any electrical or electronic components, circuits, system assemblies or any other materials or substances or environments. Any advice, recommendations or information given orally or in writing, are not to be construed as an amendment or addition to the above warranty.

See <http://www.omron.com/global/> or contact your Omron representative for published information.

## Limitation on Liability; Etc.

OMRON COMPANIES SHALL NOT BE LIABLE FOR SPECIAL, INDIRECT, INCIDENTAL, OR CONSEQUENTIAL DAMAGES, LOSS OF PROFITS OR PRODUCTION OR COMMERCIAL LOSS IN ANY WAY CONNECTED WITH THE PRODUCTS, WHETHER SUCH CLAIM IS BASED IN CONTRACT, WARRANTY, NEGLIGENCE OR STRICT LIABILITY.

Further, in no event shall liability of Omron Companies exceed the individual price of the Product on which liability is asserted.

## Suitability of Use.

Omron Companies shall not be responsible for conformity with any standards, codes or regulations which apply to the combination of the Product in the Buyer's application or use of the Product. At Buyer's request, Omron will provide applicable third party certification documents identifying ratings and limitations of use which apply to the Product. This information by itself is not sufficient for a complete determination of the suitability of the Product in combination with the end product, machine, system, or other application or use. Buyer shall be solely responsible for determining appropriateness of the particular Product with respect to Buyer's application, product or system. Buyer shall take application responsibility in all cases.

NEVER USE THE PRODUCT FOR AN APPLICATION INVOLVING SERIOUS RISK TO LIFE OR PROPERTY OR IN LARGE QUANTITIES WITHOUT ENSURING THAT THE SYSTEM AS A WHOLE HAS BEEN DESIGNED TO ADDRESS THE RISKS, AND THAT THE OMRON PRODUCT(S) IS PROPERLY RATED AND INSTALLED FOR THE INTENDED USE WITHIN THE OVERALL EQUIPMENT OR SYSTEM.

## Programmable Products.

Omron Companies shall not be responsible for the user's programming of a programmable Product, or any consequence thereof.

## Performance Data.

Data presented in Omron Company websites, catalogs and other materials is provided as a guide for the user in determining suitability and does not constitute a warranty. It may represent the result of Omron's test conditions, and the user must correlate it to actual application requirements. Actual performance is subject to the Omron's Warranty and Limitations of Liability.

## Change in Specifications.

Product specifications and accessories may be changed at any time based on improvements and other reasons. It is our practice to change part numbers when published ratings or features are changed, or when significant construction changes are made. However, some specifications of the Product may be changed without any notice. When in doubt, special part numbers may be assigned to fix or establish key specifications for your application. Please consult with your Omron's representative at any time to confirm actual specifications of purchased Product.

## Errors and Omissions.

Information presented by Omron Companies has been checked and is believed to be accurate; however, no responsibility is assumed for clerical, typographical or proofreading errors or omissions.

**OMRON Corporation** Industrial Automation Company  
Tokyo, JAPAN

Contact: [www.ia.omron.com](http://www.ia.omron.com)

**Regional Headquarters**

**OMRON EUROPE B.V.**

**Sensor Business Unit**

Carl-Benz-Str. 4, D-71154 Nufringen, Germany  
Tel: (49) 7032-811-0/Fax: (49) 7032-811-199

**OMRON ELECTRONICS LLC**

2895 Greenspoint Parkway, Suite 200  
Hoffman Estates, IL 60169 U.S.A  
Tel: (1) 847-843-7900/Fax: (1) 847-843-7787

**OMRON ASIA PACIFIC PTE. LTD.**

No. 438A Alexandra Road # 05-05/08 (Lobby 2),  
Alexandra Technopark,  
Singapore 119967  
Tel: (65) 6835-3011/Fax: (65) 6835-2711

**OMRON (CHINA) CO., LTD.**

Room 2211, Bank of China Tower,  
200 Yin Cheng Zhong Road,  
PuDong New Area, Shanghai, 200120, China  
Tel: (86) 21-5037-2222/Fax: (86) 21-5037-2200

**Authorized Distributor:**

© OMRON Corporation 2013-2015 All Rights Reserved.  
In the interest of product improvement,  
specifications are subject to change without notice.

CSM\_8\_2\_1015  
Cat. No. E432-E1-03

Printed in Japan  
0415 (0313)