

POLARIZATION OPTION A  
P/N 34729-0200

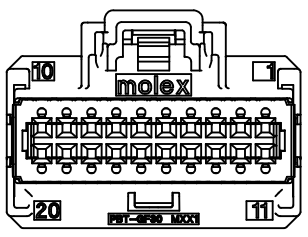

POLARIZATION OPTION B  
P/N 34729-0201

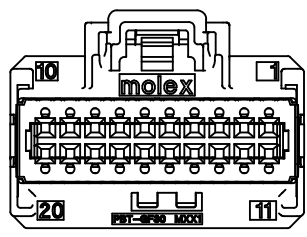

POLARIZATION OPTION C  
P/N 34729-0202

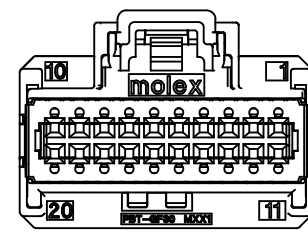

POLARIZATION OPTION D  
P/N 34729-0203

NOTES: VALID UNLESS OTHERWISE SPECIFIED

1. GENERAL:

- a. APPLICATION SPECIFICATION SEE: AS-34729-020
- b. PRODUCT SPECIFICATION SEE: PS-34729-020
- c. PACKAGING SPECIFICATION PER MOLEX DRAWING: PK-31301-201
- d. PARTS MUST BE IN COMPLIANCE TO MOLEX CHEMICAL SUBSTANCES FOR PRODUCTS AND PACKAGING SPECIFICATION: PS-40000-5015
- e. DATA MUST BE SUBMITTED UNDER THE MOLEX PART NUMBER TO IMDS (COMPANY ID#13255)

2. DESIGN - MATERIALS:

- a. SEE BOM TABLE

3. DESIGN - GEOMETRY:

- a. THIS IS A 100% CAD GENERATED PART. THE CAD MATHEMATICAL DATA IS THE MASTER FOR THIS PART. FOR DIMENSIONAL OR ANY INFORMATION NOT SHOWN ON THIS DRAWING, ANALYZE THE CAD MODEL.
- b. GEOMETRIC DIMENSIONS AND TOLERANCES PER ASME Y14.5M - 1994
- c. EDGES AND UNDIMENSIONED DETAILS PER ISO13715
- d. CORNERS SHOWN AS SHARP TO BE R 0.2 MAX.
- e. LETTERING SHALL BE 0.15 MAX RAISED IN 0.25 MAX RECESS PAD. THIS INCLUDES RECYCLING CODE, CAVITY ID, VENDOR IDENTIFICATION, AND CUSTOMER MATERIAL NUMBER.
- f. VISUAL DEFECTS SHALL MEET COSMETIC STANDARD PS-45499-002 (CLASS C)

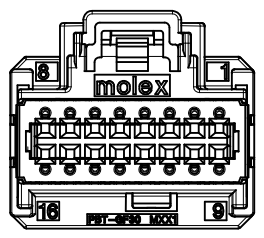

POLARIZATION OPTION A  
P/N 34729-0160

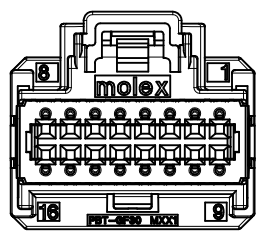

POLARIZATION OPTION B  
P/N 34729-0161

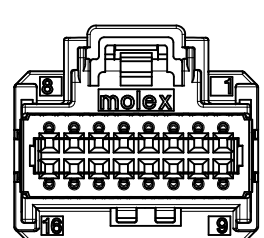

POLARIZATION OPTION C  
P/N 34729-0162

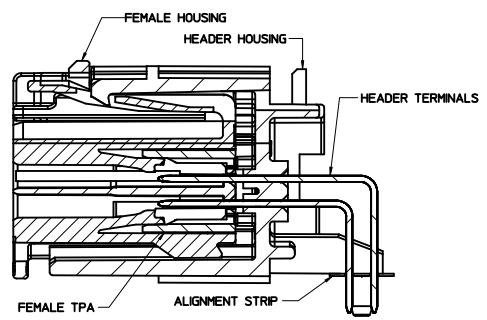

ASSEMBLY SECTION

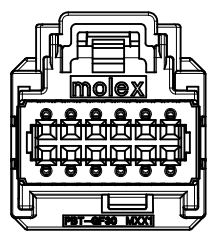

POLARIZATION OPTION A  
P/N 34729-0120

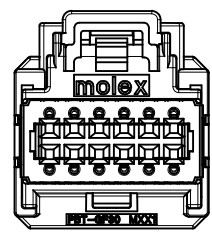

POLARIZATION OPTION B  
P/N 34729-0121

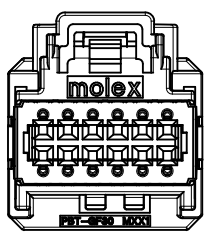

POLARIZATION OPTION C  
P/N 34729-0122

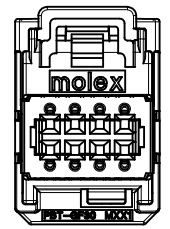

POLARIZATION OPTION A  
P/N 34729-0080

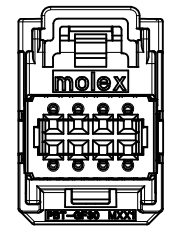

POLARIZATION OPTION B  
P/N 34729-0081

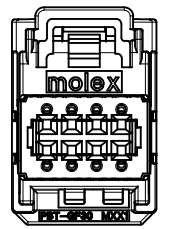

POLARIZATION OPTION C  
P/N 34729-0082

INITIAL RELEASE EC NO. UAU2010-1892 DRAWN BY MDICK 2010/05/11 CHECKED BY CDILLON 2010/08/02 APPR: SMARCEAU 2010/08/03 REV D1 DESCRIPTION	QUALITY SYMBOLS	GENERAL TOLERANCES (UNLESS SPECIFIED)	DIMENSION STYLE	SCALE	DESIGN UNITS	THIRD ANGLE PROJECTION
	$\nabla=0$ $\nabla=0$	mm INCH 4 PLACES ± --- ± --- 3 PLACES ± --- ± --- 2 PLACES ± 0.13 ± --- 1 PLACE ± 0.25 ± --- ANGULAR ± 3°	MM ONLY	4:1	METRIC	TITLE 8 - 20 CKT STAC64 (UNSEALED) RECEPTACLE ASSEMBLY
	DRAFT WHERE APPLICABLE MUST REMAIN WITHIN DIMENSIONS	DRAWN BY DATE MDICK 11/21/2008 CHECKED BY DATE CDILLON APPROVED BY DATE SMARCEAU 2010/08/02	MATERIAL NO. SEE CHART	DOCUMENT NO. SD-34729-020	MOLEX INCORPORATED	SHEET NO. 1 OF 2
		THIS DRAWING CONTAINS INFORMATION THAT IS PROPRIETARY TO MOLEX INCORPORATED AND SHOULD NOT BE USED WITHOUT WRITTEN PERMISSION				

APPLICABLE COMPONENTS			APPLICABLE WIRE SIZE	
DESCRIPTION	TYPE	SUPPLIER COMPONENTS PART NO.	WIRE GAGE	MAXIMUM INSULATION DIAMETER
MOLEX CTX64 TERMINAL	Sn	34803-0212	20 AWG	1.90mm
	Sn	34803-0211	22 AWG	1.65mm

DESCRIPTION	MOLEX ASSEMBLY PART NO.'S	COLOR	DIM. A (mm)	DIM. B (mm)	DIM. C (mm)	DIM. D (mm)	MATING COMPONENT	
							VERTICAL HEADER	RIGHT ANGLE HEADER
20 CKT STAC64 RCPT ASSEMBLY - POL A	34729-0200	BLACK	30.00	28.35	22.86	34.35	34690-0200	34691-0200
20 CKT STAC64 RCPT ASSEMBLY - POL B	34729-0201	GRAY					34690-0201	34691-0201
20 CKT STAC64 RCPT ASSEMBLY - POL C	34729-0202	BROWN					34690-0202	34691-0202
20 CKT STAC64 RCPT ASSEMBLY - POL D	34729-0203	GREEN					34690-0203	34691-0203
16 CKT STAC64 RCPT ASSEMBLY - POL A	34729-0160	BLACK	24.92	23.27	17.78	29.85	34690-0160	34691-0160
16 CKT STAC64 RCPT ASSEMBLY - POL B	34729-0161	GRAY					34690-0161	34691-0161
16 CKT STAC64 RCPT ASSEMBLY - POL C	34729-0162	BROWN	19.84	18.19	12.70	27.25	34690-0162	34691-0162
12 CKT STAC64 RCPT ASSEMBLY - POL A	34729-0120	BLACK					34690-0120	34691-0120
12 CKT STAC64 RCPT ASSEMBLY - POL B	34729-0121	GRAY					34690-0121	34691-0121
12 CKT STAC64 RCPT ASSEMBLY - POL C	34729-0122	BROWN	14.76	13.11	7.62	25.45	34690-0122	34691-0122
8 CKT STAC64 RCPT ASSEMBLY - POL A	34729-0080	BLACK					34690-0080	34691-0080
8 CKT STAC64 RCPT ASSEMBLY - POL B	34729-0081	GRAY					34690-0081	34691-0081
8 CKT STAC64 RCPT ASSEMBLY - POL C	34729-0082	BROWN					34690-0082	34691-0082

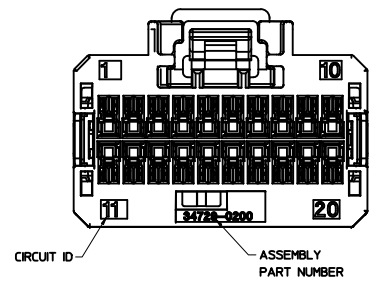
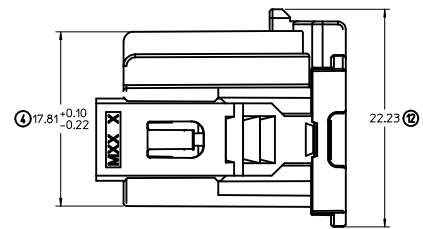
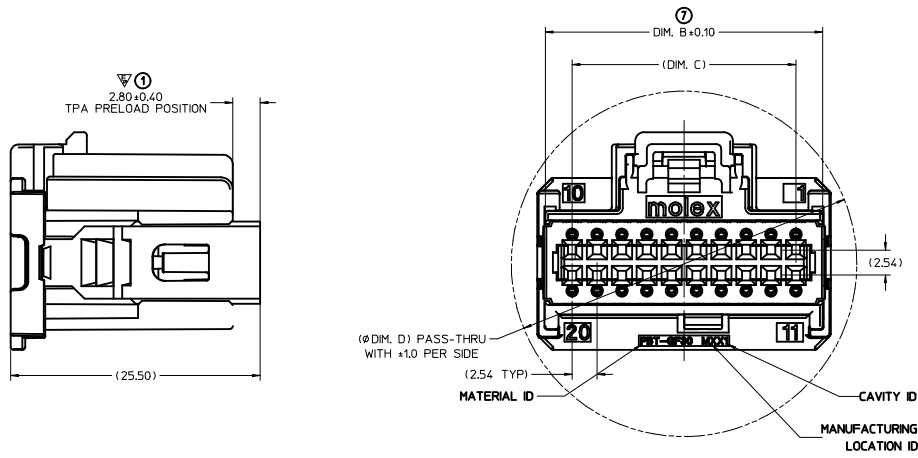
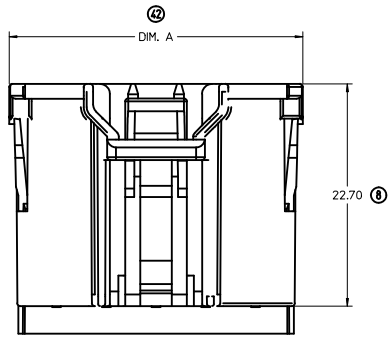

<b>INITIAL RELEASE</b> IEC NO. UAU2010-1892 DRAWN BY CD LICK CHYK/CD LILLON APPR: SMARCEAU 2010/05/11 2010/08/02 2010/08/03	<b>QUALITY SYMBOLS</b> ▽=0 ▽=0 ▽=0	<b>GENERAL TOLERANCES (UNLESS SPECIFIED)</b>		<b>DIMENSION STYLE</b> MM ONLY	<b>SCALE</b> 4:1	<b>DESIGN UNITS</b> METRIC	THIRD ANGLE PROJECTION	
		4 PLACES ± 0.13 3 PLACES ± 0.13 2 PLACES ± 0.13 1 PLACE ± 0.25	mm INCH	DATE 11/21/2008	DATE 11/21/2008	<b>TITLE</b> 8 - 20 CKT STAC64 (UNSEALED) RECEPTACLE ASSEMBLY		
		ANGULAR ± 3°	DATE 2010/08/02	DATE 2010/08/02	<b>MOLEX INCORPORATED</b>			
		DRAFT WHERE APPLICABLE MUST REMAIN WITHIN DIMENSIONS	MATERIAL NO. SEE CHART	DOCUMENT NO. SD-34729-020	SHEET NO. 2 OF 2			