

5mm Round With Flange Type  
Infrared LED  
Technical Data Sheet

Part No.: 503IRT2E-2AC

## Features:

- ◇ Standard T-1 3/4 package.
- ◇ Viewing angle=20°.
- ◇ Low forward voltage.
- ◇ High radiant intensity.
- ◇ Reliable and rugged.
- ◇ The product itself will remain within RoHS complaint Version.

## Descriptions:

- ◇ The device is spectrally matched with silicon photodiode and phototransistor.

## Applications:

- ◇ Floppy disk drive.
- ◇ Optoelectronic switch.
- ◇ Camera.
- ◇ Video.
- ◇ Infrared remote control units with high power requirement
- ◇ Free air transmission system.

## Package Dimension:

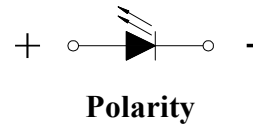
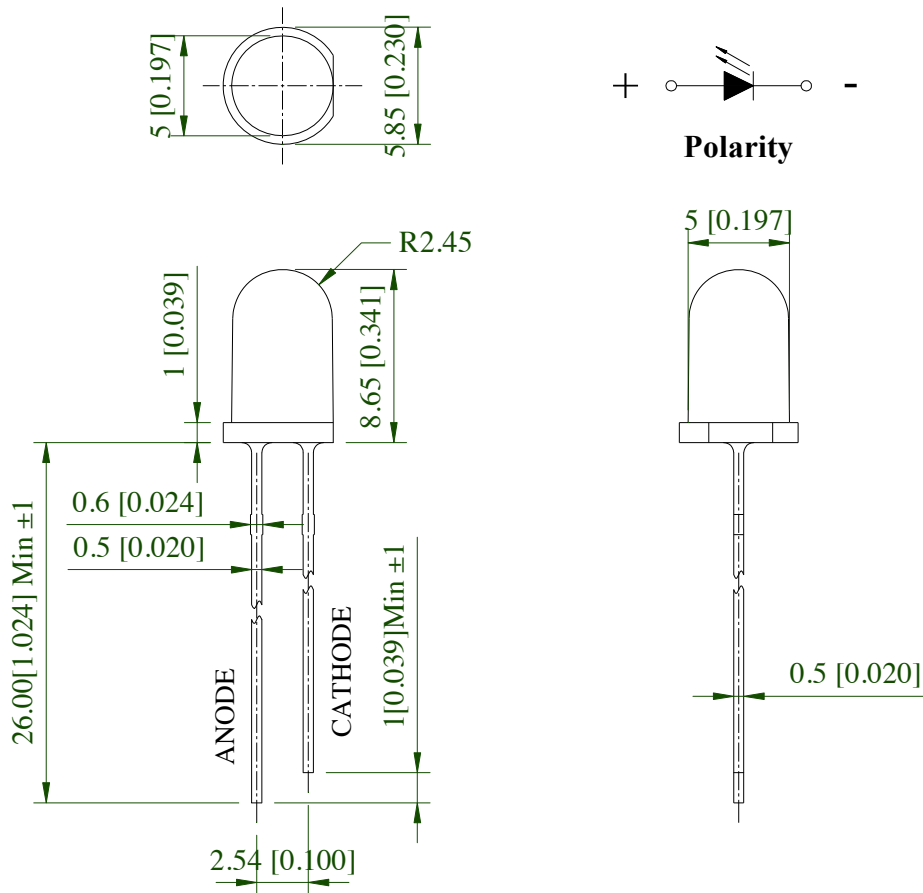

Part No.	Chip Material	Lens Color	Source Color
503IRT2E-2AC	GaAlAs	Blue Transparent	Infrared

### Notes:

1. All dimensions are in millimeters (inches).
2. Tolerance is  $\pm 0.25$  (.01" ) mm unless otherwise specified.
3. Protruded resin under flange is 1.0 mm (.04" ) max.
4. Specifications are subject to change without notice.

## Absolute Maximum Ratings at Ta=25°C

Parameters	Symbol	Max.	Unit
Power Dissipation	PD	100	mW
Peak Forward Current (1/10 Duty Cycle, 0.1ms Pulse Width)	IFP	1	A
Forward Current	IF	100	mA
Reverse Voltage	VR	5	V
Operating Temperature Range	Topr	-40°C to +85°C	
Storage Temperature Range	Tstg	-40°C to +100°C	
Soldering Temperature [4mm(.157" ) From Body]	Tsld	260°C for 5 Seconds	

## Electrical Optical Characteristics at Ta=25°C

Parameters	Symbol	Min.	Typ.	Max.	Unit	Test Condition
Radiant Intensity (Note 1) *	Ee	7.0	12.0	---	mW/sr	IF=20mA
		20.0	45.0	---		IF=50mA
Viewing Angle (Note 2) *	2θ <sub>1/2</sub>	---	20	---	Deg	IF=20mA (Note 1)
Peak Emission Wavelength	λ <sub>p</sub>	---	940	---	nm	IF=20mA
Spectral Bandwidth	Δλ	---	50	---	nm	IF=20mA
Forward Voltage	VF	0.80	1.20	1.50	V	IF=20mA
		1.00	1.30	1.70		IF=50mA
Reverse Current	IR	---	---	10	μA	V <sub>R</sub> =5V

### Notes:

1.θ<sub>1/2</sub> is the off-axis angle at which the luminous intensity is half the axial luminous intensity.

Typical Electrical / Optical Characteristics Curves  
 (25°C Ambient Temperature Unless Otherwise Noted)

Spectral Distribution

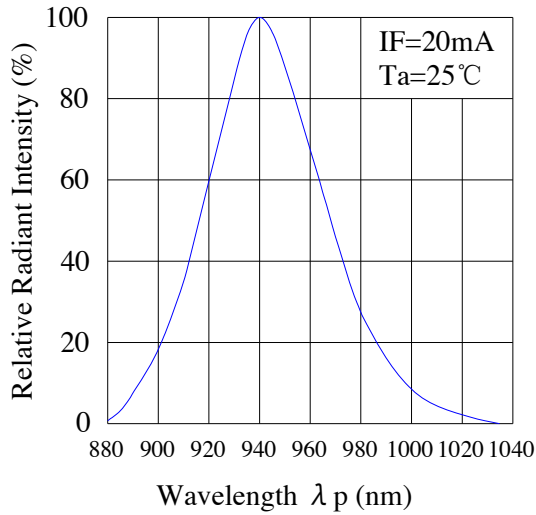

Forward Current & Forward Voltage

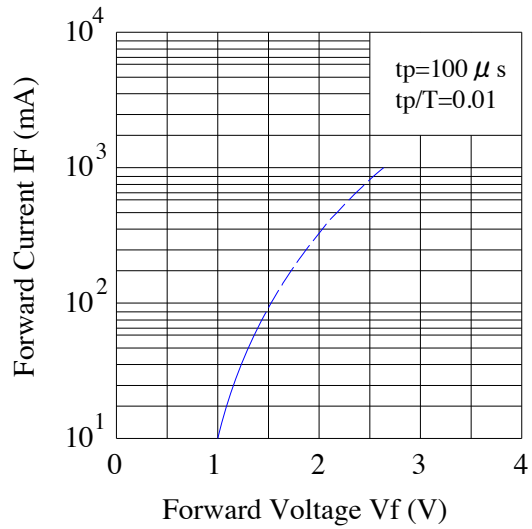

Peak Emission Wavelength & Ambient Temperature

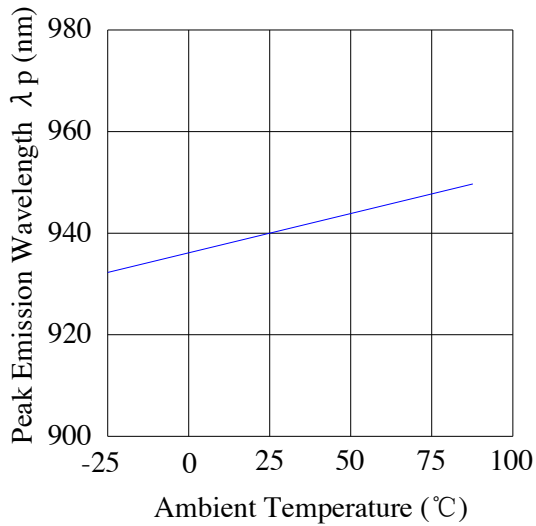

Forward Current & Ambient Temperature

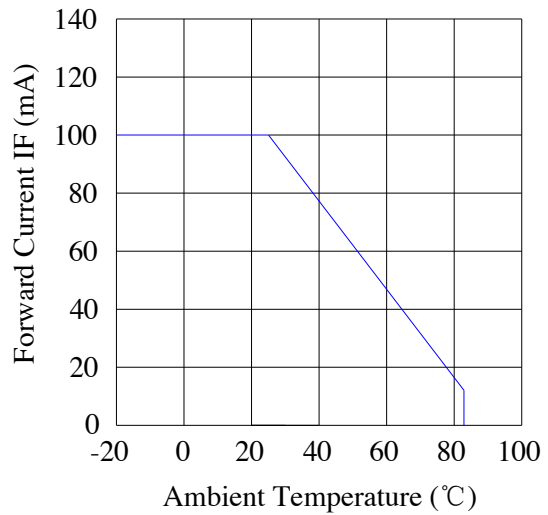

**Fig.5 Relative Intensity vs. Forward Current**

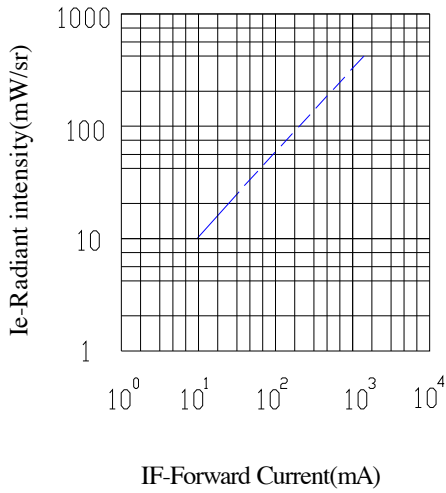

**Fig.6 Relative Radiant Intensity vs. Angular Displacement**

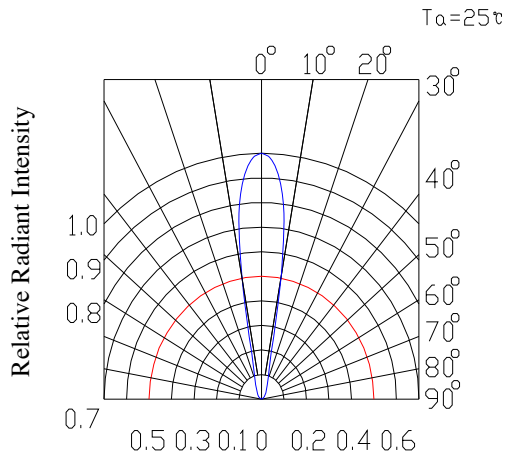

**Fig.7 Relative Intensity vs. Ambient Temperature (°C)**

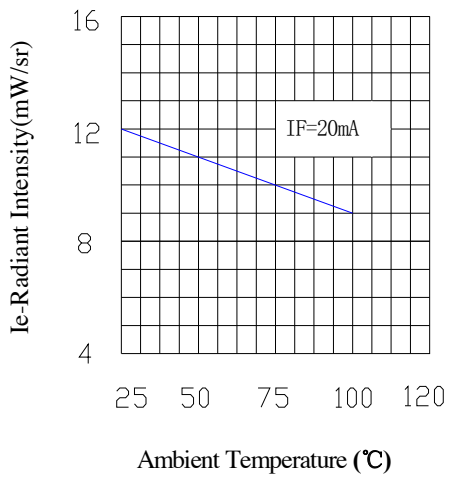

**Fig.8 Forward Voltage vs. Ambient Temperature (°C)**

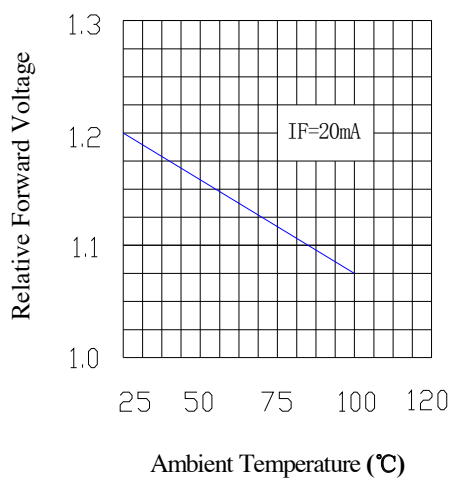

## Reliability Test Items And Conditions:

The reliability of products shall be satisfied with items listed below:

Confidence level: 90%.

LTPD: 10%.

### 1) Test Items and Results:

No.	Item	Test Conditions	Test Hours/ Cycles	Sample Sizes	Failure Judgment Criteria	Ac/ Re
1	Reflow Soldering	TEMP.: 260°C±5°C 5secs	6mins	22pcs	$IR \geq U \times 2$ $Ee \leq L \times 0.8$ $VF \geq U \times 1.2$  U: Upper Specification Limit L: Lower Specification Limit	0/1
2	Temperature Cycle	H: +100°C 15mins └ 5 mins └ L: -40°C 15mins	50Cycles	22pcs		0/1
3	Thermal Shock	H: +100°C 15mins └ 10mins └ L: -10°C 5mins	50Cycles	22pcs		0/1
4	High Temperature Storage	TEMP.: +100°C	1000hrs	22pcs		0/1
5	Lower Temperature Storage	TEMP.: -40°C	1000hrs	22pcs		0/1
6	DC Operating Life	V <sub>CE</sub> =5V	1000hrs	22pcs		0/1
7	High Temperature/ High Humidity	85°C / 85% R.H	1000hrs	22pcs		0/1

### 2) Criteria For Judging The Damage:

Item	Symbol	Test Conditions	Criteria for Judgment	
			Min	Max
Forward Voltage	VF	IF=50mA	—	F.V.*)×1.1
Reverse Current	IR	VR=5V	—	F.V.*)×2.0

\*) F.V.: First Value.

## Please read the following notes before using the product:

### 1. Over-current-proof

Customer must apply resistors for protection, otherwise slight voltage shift will cause big current change (Burn out will happen).

### 2. Storage

2.1 Do not open moisture proof bag before the products are ready to use.

2.2 Before opening the package, the LEDs should be kept at 30°C or less and 80%RH or less.

2.3 The LEDs should be used within a year.

2.4 After opening the package, the LEDs should be kept at 30°C or less and 60%RH or less.

2.5 The LEDs should be used within 168 hours (7 days) after opening the package.

### 3. Soldering Iron

Each terminal is to go to the tip of soldering iron temperature less than 260°C for 5 seconds within once in less than the soldering iron capacity 25W. Leave two seconds and more intervals, and do soldering of each terminal. Be careful because the damage of the product is often started at the time of the hand solder.

### 4. Soldering

When soldering, for Lamp without stopper type and must be leave a minimum of 3mm clearance from the base of the lens to the soldering point.

To avoided the Epoxy climb up on lead frame and was impact to non-soldering problem, dipping the lens into the solder must be avoided.

Do not apply any external stress to the lead frame during soldering while the LED is at high temperature.

Recommended soldering conditions:

Soldering Iron		Wave Soldering	
Temperature	300°C Max.	Pre-heat	100°C Max.
Soldering Time	3 sec. Max. (one time only)	Pre-heat Time	60 sec. Max.
		Solder Wave	260°C Max.
		Soldering Time	5 sec. Max.

Note: Excessive soldering temperature and / or time might result in deformation of the LED lens or catastrophic failure of the LED.

### 5. Repairing

Repair should not be done after the LEDs have been soldered. When repairing is unavoidable, a double-head soldering iron should be used. It should be confirmed beforehand whether the characteristics of the LEDs will or will not be damaged by repairing.

### 6. Caution in ESD

Static Electricity and surge damages the LED. It is recommended to use a wrist band or anti-electrostatic glove when handling the LED. All devices equipment and machinery must be properly grounded.