

Datasheet

Feed Through Connectors

RS Stock number 874-1241



Description:

All fit within a standard XLR panel cut out, and use common cabling for front and back connections. No soldering, no punch terminations, just use the standard cable for that particular connector style. Mount from the front or back, low rear profile accommodates the tightest “behind the panel” spaces. Available in a wide variety of styles.

Unit: mm

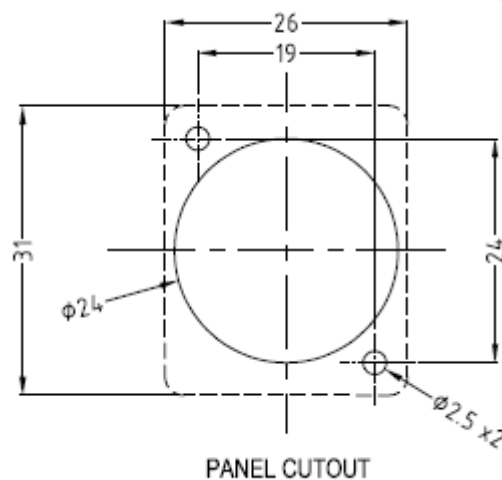



Part No.
8741188
8741232

Description
HDMI A Female to HDMI A, Gold Plated, CSK hole.
As above with Plain hole.



Part No.
8741197
8741235

Description
USB 3.0 A to USB 3.0 A, Nickel Plated, CSK hole.
As above with Plain hole



Part No.
8741190
8741239

Description
USB 3.0 B to USB 3.0 A, Nickel Plated, CSK hole.
As above with Plain hole



Part No.
8741194
8741248

Description
USB 2.0 B to USB 2.0 A, Nickel Plated, CSK hole.
As above with Plain hole



Part No.
8741204
8741241

Description
USB 2.0 A to USB 2.0 A, Nickel Plated, CSK hole.
As above with Plain hole



Part No.
8741207
8741245

Description
LC Duplex SM adaptor, Black, CSK Hole
As above with Plain hole



Part No.
8741201
8741254

Description
LC Duplex MM adaptor, Black, CSK Hole
As above with Plain hole



Part No.
8741210
8741257

Description
SC Simplex SM adaptor, Black, CSK Hole
As above with Plain hole



Part No.
8741213
8741251

Description
SC Simplex MM adaptor, Black, CSK Hole
As above with Plain hole



Part No.
8741217
8741260

Description
FTP Cat5e RJ45-RJ45, Shielded, CSK Hole
As above with Plain hole



Part No.
8741226
8741263

Description
UTP Cat5e RJ45-RJ45, CSK Hole
As above with Plain hole



Part No.
8741229
8741267

Description
FTP Cat6 RJ45-RJ45, Shielded, CSK Hole
As above with Plain hole



Part No.
8741223
8741276

Description
UTP Cat6 RJ45-RJ45, CSK Hole
As above with Plain hole