



Film Capacitors 2018

NISSEI ELECTRIC CO., LTD

フィルムコンデンサ/Film Capacitors

構造 Construction	誘電体 Dielectric	品名 Type	外観 Appearance	特徴及び用途 Feature and Application	定格電圧 Rated voltage	静電容量範囲 Capacitance range (μF)	使用温度範囲 Temp. range (°C)	頁 Page
樹脂ディップ タブ構造 Tab structure, Resin dipped	ポリエステルフィルム POLYESTER FILM	AMZ (B) AMZ		一般電子回路用 General purpose application スナバ回路用 Snubber circuits	50Vdc 100 250 400	0.00010~0.15 0.00010~0.12 0.0010 ~0.047 0.0010 ~0.018	-40~+85 (+105) ^{*1}	17 ? 19
	ポリプロピレンフィルム POLYPROPYLENE FILM	APS (A) APS		低損失 Low dissipation factor 高周波回路用 For high frequency circuits オーディオ回路用 For audio circuits スナバ回路用 Snubber circuits	100Vdc 250 400	0.00010~0.22 0.00010~0.010 0.0010 ~0.010	-40~+85	20 . 21
	ポリフェニレン スルフィドフィルム POLYPHENYLENE SULFIDE FILM	AHS		温度係数小 Flat-temperature coefficient 高耐熱 High temperature resistance	50Vdc 100	0.00027~0.47 0.00018~0.010	-55~+125	22 . 23
	ポリエステルフィルム POLYESTER FILM	NSM (A)		蛍光灯雑音防止用 Noise suppression for fluorescent lamp 蛍光灯接地用 Ground capacitor for fluorescent lamp	220Vac 250 220Vac 250	0.0060 0.0060 0.0010~0.010 0.0010~0.010	-40~+85 -40~+85 (+105) ^{*1}	24
難燃性 樹脂ディップ Flame retardant resin dipped	メタライズド ポリエステルフィルム METALLIZED POLYESTER FILM	MMX		小型品 Miniature size 一般電子回路用 General purpose application	250Vdc 400 450 630	0.0010~10.0 0.0010~ 4.7 0.10 ~ 4.7 0.0010~ 2.2	-40~+85 (+105) ^{*1}	25 ? 27
		MMC		小型品 Miniature size 一般電子回路用 General purpose application	100Vdc 250 400 450 630 1000 1250	0.033 ~ 4.7 0.0010~10.0 0.0010~ 4.7 0.0010~ 3.3 0.0010~ 2.2 0.0010~0.47 0.0010~0.22	-40~+85 (+105)	28 ? 32
		MMB (A)		低E.S.R. Low E.S.R. 高周波高リップル電流回路用 High frequency high ripple circuits 平滑回路用 Smoothing circuits	35Vdc 63	4.7, 10.0, 22.0 4.7, 10.0, 22.0	-40~+105	33
		MML		小型品 Miniature size 交流電源雑音防止用 Noise suppression for AC line	125Vac	0.010~4.7	-40~+105	34 ?
		MMD		高信頼性 High reliability 交流電源雑音防止用 Noise suppression for AC line	125Vac 250	0.010~1.0 0.010~0.47	-40~+105	36

1 () 温度は電圧軽減による使用範囲です。

2 電球形蛍光灯用に限る。

カタログ掲載製品の仕様、材質、その他記載内容について変更する場合がありますので、予めご了承下さい。

ご使用に当たっては、使用上の注意事項(9-12頁)をご確認の上、仕様書などをお求め願ひ、仕様書の範囲内でのご使用をお願いします。









※1 () Marked temperature shows maximum operating range when voltage is derated.

※2 Only for compact fluorescent bulbs ballast

Specifications of products, materials and other contents stated in the catalog are subject to change without notice.

When using our capacitors, please consider the application notes on pages 9-12 and contact NISSEI for any additional specifications relating to the limits of our performance characteristics.

フィルムコンデンサ/Film Capacitors

構造 Construction	誘電体 Dielectric	品名 Type	外観 Appearance	特徴及び用途 Feature and Application	定格電圧 Rated voltage	静電容量範囲 Capacitance range (μF)	使用温度範囲 Temp. range ($^{\circ}C$)	頁 Page									
難燃性 樹脂ディップ Flame retardant resin dipped	メタライズド ポリプロピレンフィルム METALLIZED POLYPROPYLENE FILM	MPE		高信頼性 High reliability 高周波・共振回路用 High frequency, resonant circuits	250Vdc	0.010 ~ 10.0	-40~+105	37 40									
					400/450	0.010 ~ 3.3											
					630	0.010 ~ 2.2											
					800	0.0010 ~ 0.68											
					1000	0.0010 ~ 0.22											
					1250	0.0010 ~ 0.18											
					1600	0.0010 ~ 0.10											
NEW	MPX		小型品 Miniature size 一般電子回路用 General purpose application	450Vdc	0.10~0.27	-40~+85 (+105)*	41 42										
				630Vdc	0.10~2.2												
				MPW				小型品 Miniature size 低うなり音 Low beat sound 一般電子回路用 General purpose application	450Vdc	0.33~4.7	-40~+85 (+105)*	43					
									MPW(X)				小型品 Miniature size 低うなり音 Low beat sound 一般電子回路用 General purpose application	450Vdc	0.47~4.7	-40~+85 (+110)	44
														MPW(Z)			
MPE(A)		高信頼性 High reliability 高周波・共振回路用 High frequency, resonant circuits	250Vdc	6.8~15.0	-40~+85 (+105)	46											
			400	2.2													
MPU		低損失 Low dissipation factor 高周波・高電圧回路用 High frequency, high voltage circuits	2000Vdc	0.01, 0.047	-40~+105	47											
			3000	0.0024~0.0082													
樹脂ディップ 積層形 Stacked, Resin dipped	メタライズド ポリエステルフィルム METALLIZED POLYESTER FILM	MMT(A) MMT		小型品 Miniature size 一般電子回路用 General purpose application	50Vdc	0.010~3.3	-40~+85 (+105)*	48 49									
					63	0.010~3.3											
					100	0.010~1.0											
MTF(A)		小型品 Miniature size 無酸素銅線 OFC wire オーディオ用 Audio application	50Vdc	0.010~3.3	-40~+85 (+105)*												

() 温度は電圧軽減による使用範囲です。

※ () Marked temperature shows maximum operating range when voltage is derated.

カタログ掲載製品の仕様、材質、その他記載内容について変更する場合がありますので、予めご了承下さい。

Specifications of products, materials and other contents stated in the catalog are subject to change without notice.

ご使用に当たっては、使用上の注意事項(9-12頁)をご確認の上、仕様書などをお求め願ひ、仕様書の範囲内でのご使用をお願いします。

When using our capacitors, please consider the application notes on pages 9-12 and contact NISSEI for any additional specifications relating to the limits of our performance characteristics.

フィルムコンデンサ / Film Capacitors

構造 Construction	誘電体 Dielectric	品名 Type	外観 Appearance	特徴及び用途 Feature and Application	定格電圧 Rated voltage	静電容量範囲 Capacitance range (μ F)	使用温度範囲 Temp. range ($^{\circ}$ C)	頁 Page
樹脂ディップ 積層形 Stacked, Resin dipped	メタライズド ポリエステルフィルム METALLIZED POLYESTER FILM	MMT (B)		小型品 Miniature size 一般電子回路用 General purpose application	50/63Vdc 100 250 450 630	0.010 ~3.3 0.010 ~1.0 0.0010~0.33 0.0010~0.10 0.0010~0.010	-40~+85 (+105)*	50 ~ 52
		MMT (P)		小型品 Miniature size 点火装置 (CDI) 用 Ignition device (CDI)	250Vdc	0.47 ~1.2	-40~+85 (+105)*	53
積層チップ形 Stacked chip type	メタライズド ポリフェニレン スルフィドフィルム METALLIZED POLYPHENYLENE SULFIDE FILM	CHA		リフロー/フロー対応表面実装用 Reflow and flow soldering SMD フィルター回路、発振回路、時定数回路用 Filter, Oscillation, Time constant circuits	16Vdc 50	0.00010~0.10 0.00010~0.22	-55~+125	54
樹脂ケース密封形 Flame retardant box type	メタライズド ポリプロピレンフィルム METALLIZED POLYPROPYLENE FILM	MP1		電子機器電源雑音防止用 クラスX2 Interference suppression Class X2	310Vac	0.010~4.7	-40~+110	55
		BPW		小型品 Miniature size 低うなり音 Low beat sound 一般電子回路用 General purpose application	450Vdc 630	0.47, 1.0 0.47, 2.2	-40~+85 (+105)*	56
		NEW BPW (X)		小型品 Miniature size 低うなり音 Low beat sound 一般電子回路用 General purpose application	450Vdc	0.47~4.7	-40~+85 (+105)	57
		MPY		小型品 Miniature size フィルター回路用 Filter circuits	630Vdc 720	4.5, 10.0	-40~+85 (+105)*	58
		NEW DLC DLC (A) DLC (B)		小型品 Miniature size インバーター回路平滑用 Inverter circuit smoothing capacitor	450~ 2000Vdc	18~2800 μ F	-40~+85	59

※ () 温度は電圧軽減による使用範囲です。

※ () Marked temperature shows maximum operating range when voltage is derated.

カタログ掲載製品の仕様、材質、その他記載内容について変更する場合がありますので、予めご了承下さい。

Specifications of products, materials and other contents stated in the catalog are subject to change without notice.

ご使用に当たっては、使用上の注意事項(9-12頁)をご確認の上、仕様書などをお求め願ひ、仕様書の範囲内でのご使用をお願いします。

When using our capacitors, please consider the application notes on pages 9-12 and contact NISSEI for any additional specifications relating to the limits of our performance characteristics.

NISSEI 製品呼称 PART NUMBER CODE SYSTEM

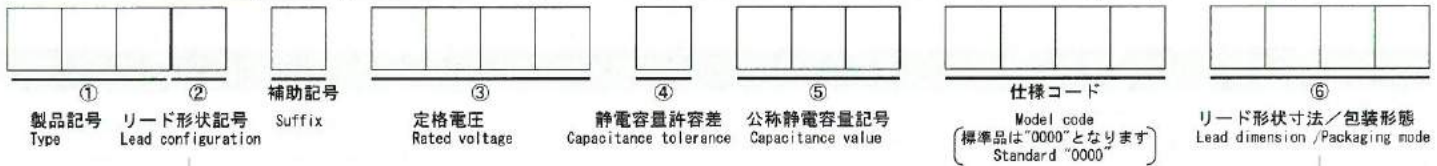

② リード形状記号 Lead configuration code		⑥ リード形状寸法/包装形態 ^{※2} Lead dimension / Packaging mode code ^{※2}				記号の説明 Description	
コード code	リード加工の形状 Lead configuration	記号の記入例 Typical code samples				記号の説明 Description	
※1	ストレートリード Straight leads	0000				ストレートリード (バルク包装品) は、0000になります。 No lead processing and always in bulk (0000)	
C	リードカット Short leads	0050				リードカットは、長さ別に、寸法記号を設定しており、標準品は5mmで、0050になります。 Lead length multiplied by 10. Always in bulk.	
F	フォーミング Formed (leads)	F寸法 (mm) Lead spacing	コード Code	F寸法 (mm) Lead spacing	コード Code	Fはフォーミング品のリードスペースを表します。 (バルク製品) Lead spacing (F) after forming indicated as multiplied by 10. Always in bulk.	
		5.0	0050	17.5	0175		
		7.5	0075	20.0	0200		
		10.0	0100	22.5	0225		
		12.5	0125	25.0	0250		
S	自動挿入用縦型テーピング (ストレートリード型) Lead taping for automatic insertion machine (Straight leads)	スタイル Style		コード Code		ストレート品・フォーミング品のテーピングスタイルを表します。 (つづら折り包装品) 詳しくは6~7頁の自動挿入用テーピング仕様をご覧ください。 Straight leads・Formed leads taped and ammo packed. See page 6-7.	
		1	0200 ^{※3}				
		1	0200				
		2	0200				
		3	0210				
V	自動挿入用縦型テーピング (フォーミングリード型) Lead taping for automatic insertion machine (Formed leads)	スタイル Style		コード Code		チップ形のテーピングスタイルを表します。詳しくは8頁の自動装着用テーピング仕様をご覧ください。 Chip type taping. See page 8.	
		4	0220				
		5	0200				
	自動装着用テーピング Taping for automatic mounting machine	0400					

※1 ストレートリードの場合、コードはブランクになります。
The blank square signifies a straight leads type.
※2 タイプにより、リード形状の寸法記号が異なる場合がありますのでご注文の際はご確認願います。
Some types could bear different lead dimension codes, to be confirmed each case.
※3 AMZタイプにおけるコードは"0220"になります。
AMZ type shall be "0220".

③ 定格電圧/Rated voltage (Vdc, Vac)

V/Voltage	16	35	50	63	100	125	220	250	400	450	630	800	1000	1250	1600
コード/Code	0016	0035	0050	0063	0100	0125	0220	0250	0400	0450	0630	0800	1000	1250	1600

④ 静電容量許容差記号/Capacitance tolerance code

コード/Code	F	G	H	J	K	M
許容差(%) / Tolerance (%)	±1	±2	±3	±5	±10	±20

⑤ 公称静電容量記号

pFを単位として3ケタの数字で表します。
最初の2数字：公称静電容量の有効数字
第3の数字：後に続く0の数

⑤ Capacitance code

Capacitance (pF) expressed in 3-digit code.
The first two digits: Significant figures of capacitance value.
The third digit: The number of zeros to follow the significant figures.

記入例 Coding sample

- 1) AMZ 50V 0.10μF ±5% のフォーミング品をつづら折りテーピングでご注文の場合
Coding of: AMZ 50V 0.10μF ±5%, formed, taped and ammo-packed

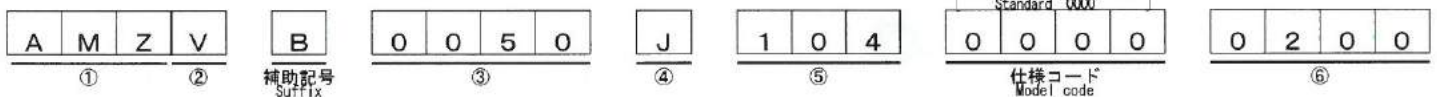

- 2) MMC 250V 1.0μF ±10% のフォーミング品をフォーミング寸法15.0mmのバルク品でご注文の場合
Coding of: MMC 250V 1.0μF ±10%, formed with 15.0mm leads, in bulk

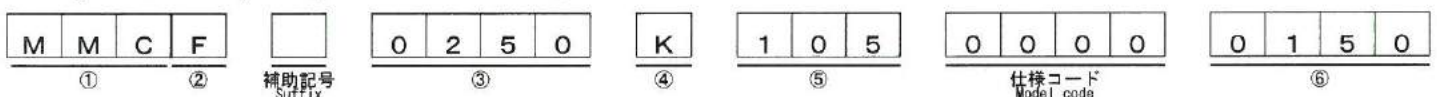

- 2) MMT 50V 0.1μF ±5% のストレート品をご注文の場合 (バルク品)
Coding of: MMT 50V 0.1μF ±5%, straight lead (in bulk)

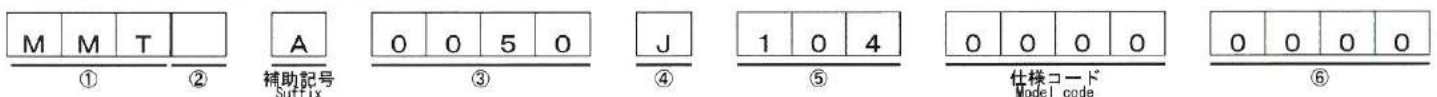

NISSEI コンデンサの諸特性 PERFORMANCE CHARACTERISTICS

●諸特性は、静電容量、電圧などの定格によって多少異なります。下図は静電容量0.1 μ Fの測定値の一例です。

★Various characteristics are slightly different depending on capacitance and voltage. An example of measurement for capacitance 0.1 μ F is shown in the figures below.

周波数特性/Frequency Characteristics

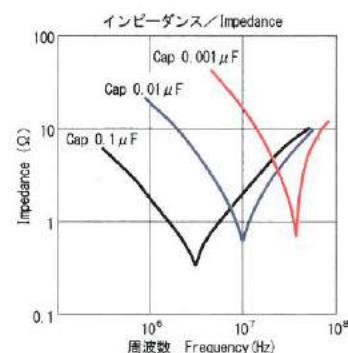
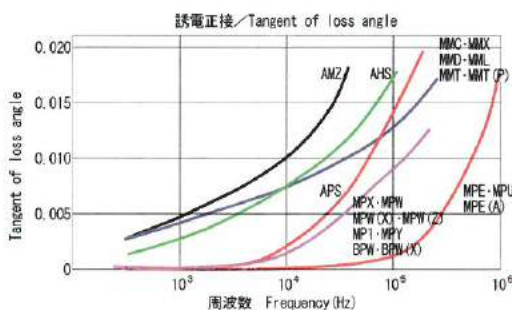
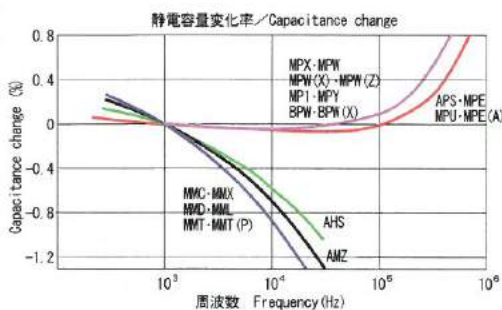

温度特性/Temperature Characteristics

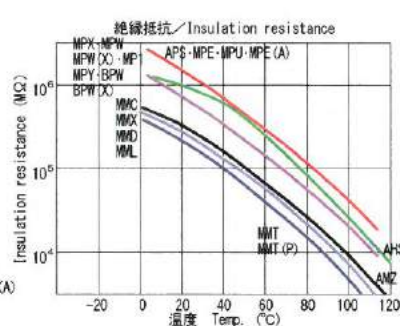
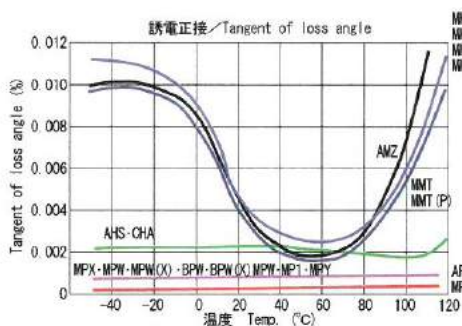
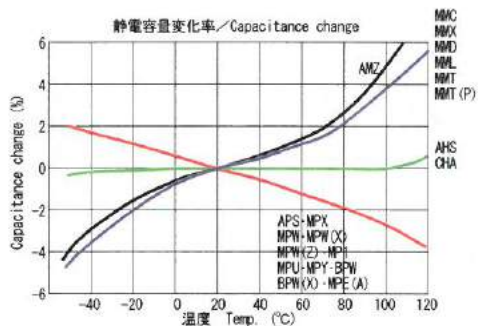

高温負荷/High Temperature Endurance

試験温度/Test temperature: 定格温度上限/Maximum rated temperature

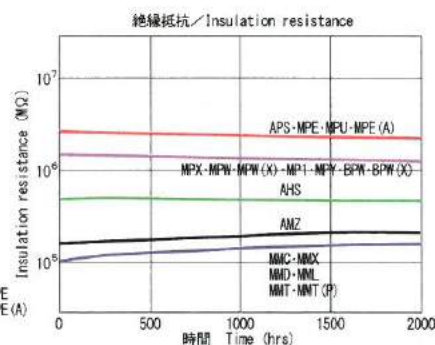
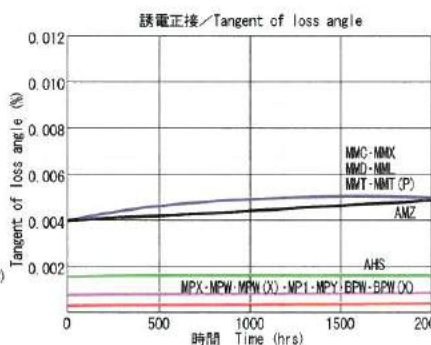
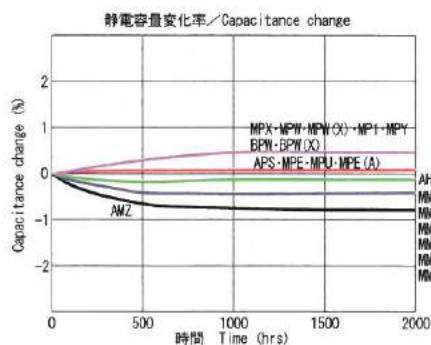

耐湿負荷/Damp Heat Endurance

試験温度/Test temperature: 40 $^{\circ}$ C 湿度/Humidity: 95%RH

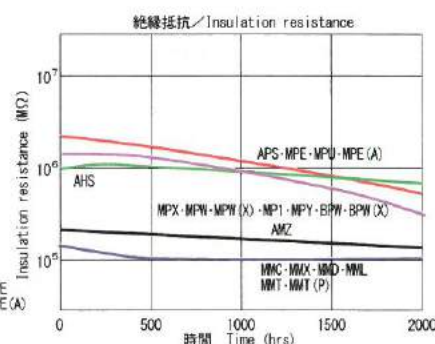
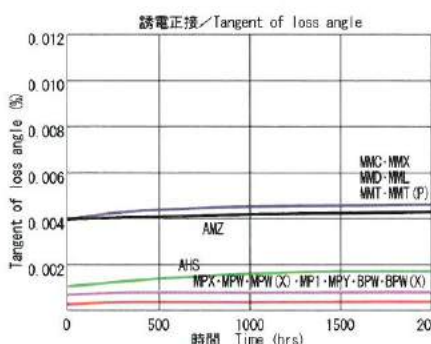
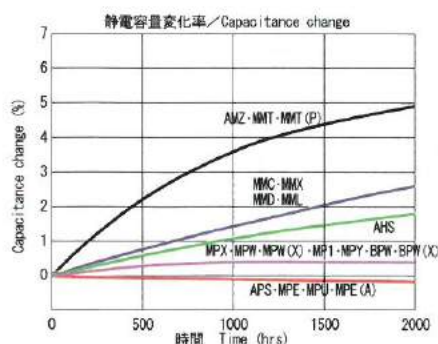

適用品種 / Applications

Type	WV	フォーミングリードタイプ / Formed Lead Type		
		Style1	Style2	Style5
スタイルコード		0200	D200	0200
AMZ (B)	50	273~154		
	100	101~104	114~124	114~124
AMZ	50	101~243		
	250	102~333	393~473	393~473
	400	102~103	123~183	123~183
APS (A)	100	101~363	393~124	393~124
APS	250	101~103		
	400	102~103		
AHS	50	271~104	114~184	114~184
	100	181~103		
MMT (A)	50	103~155		
	63	103~155		
MMT	100	103~105		
	250	103~224		
MTF	50	103~155		
MMT (B)	50/63	103~155		
	100	103~105		
	250	102~334		
	450	102~104		
MMC	100	333~474	564~105	564~105
	250	102~154	184~334	184~334
	400/450	102~333	393~104	393~104
	630	102~822	103~473	103~473
MMX	250	102~334	394~684	394~684
	400	102~104	124~474	124~474
	450	104	124~474	124~474
	630	102~473	563~224	563~224
MMD	125	103~683	823~224	823~224
	250		103~473	103~473
MML	125	103~224	274~684	274~684
MPE	250		103~913	103~913
	400/450		103~913	103~913
	630		103~303	103~303

標準テーピング寸法 / Taping Dimensions (mm)

形状	フォーミングリードタイプ / Formed Lead Type		
	Style1	Style2	Style5
P	12.7±1.0	15.0±1.0	15.0±1.0
P ₀	12.7±0.3	15.0±0.3	15.0±0.3
P ₁	3.85±0.7	5.0±0.7	3.75±0.7
P ₂	6.35±1.3	7.5±1.3	7.5±1.3
φd	タイプ別寸法表参照 / See individual dimensions		
F	5.0±0.5	5.0±0.5	7.5±0.5
Δh	0±2.0	0±2.0	0±2.0
W	18.0±0.8	18.0±0.8	18.0±0.8
W ₀	5.0Min	5.0Min	5.0Min
W ₁	9.0±0.5	9.0±0.5	9.0±0.5
W ₂	3.0Max	3.0Max	3.0Max
H ₀	16.0±0.5	16.0±0.5	16.0±0.5
D ₀	4.0±0.2	4.0±0.2	4.0±0.2
t	0.7±0.2	0.7±0.2	0.7±0.2
H	21.25Max	22.0Max	22.0Max

Type	WV	ストレートリード Straight Lead Type
AMZ	50	101~243
AMZ (B)	50	273~154
	100	101~104
AHS	50	271~104
NSM	220	602
	250	602
MMT (A)	50	103~105
	63	103~105
MMT	100	103~105
	250	103~224
MMT (B)	50/63	103~105
	100	103~105
	250	102~154
	450	102~333
	630	102~103

形状	ストレートリード Straight Lead Type
P	12.7±1.0
P ₀	12.7±0.3
P ₁	3.85 or 4.6±0.7
P ₂	6.35±1.3
φd	タイプ別寸法表参照 / See individual dimensions
F	3.5 or 5.0 or 7.5 ±0.5
Δh	0±2.0
W	18.0±0.8
W ₀	5.0Min
W ₁	9.0±0.5
W ₂	3.0Max
D ₀	4.0±0.2
t	0.7±0.2
H	18.5±0.5*

*NSMSの場合はH寸法16.0±0.5となります。

NSMS : H=16.0±0.5

適用品種 / Applications

Type	WV	フォーミングリードタイプ / Formed Lead Type		
		Style3	Style4	Style6
スタイルコード		D210	D220	0200
AHS	50		204~334	204~334
MMC	100	125~225		125~225
	250	394~125		394~155
	400/450	124~474		124~474
	630	563~224		563~224
MMX	250	394~125		824~395
	400	124~105		564~125
	450	124~105		564~125
	630	563~394		274~564
MMD	125	274~474		274~474
	250	563~184		563~224
MML	125	824~275		824~275
	250	103~334		104~105
	400/450	103~274		104~364
MPE	630	103~563		333~204
	800	102~303		102~104
	1000	102~303		102~104
	1250	102~163		102~513
	1600	102~912		102~203
MPX	450	104~274		104~274
	630	104~334		104~564
MPW	450	334~155		334~225
MPW(X)	450	474~225		474~475
				0129:474~335

標準テーピング寸法 / Taping Dimensions (mm)

形状	フォーミングリードタイプ / Formed Lead Type		
	Style3	Style4	Style6
P	25.4±1.0	30.0±1.0	30.0±1.0
P ₀	12.7±0.3	15.0±0.3	15.0±0.3
P ₁	3.85±0.7	5.0±0.7	3.75±0.7
P ₂	6.35±1.3	7.5±1.3	7.5±1.3
φd	タイプ別寸法表参照 / See individual dimensions		
F	5.0±0.8	5.0±0.8	7.5±0.8
Δh	0±2.0	0±2.0	0±2.0
W	18.0±0.8	18.0±0.8	18.0±0.8
W ₀	5.0Min	5.0Min	5.0Min
W ₁	9.0±0.5	9.0±0.5	9.0±0.5
W ₂	3.0Max	3.0Max	3.0Max
H ₀	16.0±0.5	16.0±0.5	16.0±0.5
D ₀	4.0±0.2	4.0±0.2	4.0±0.2
t	0.7±0.2	0.7±0.2	0.7±0.2
H	22.0Max	22.0Max	22.0Max

形状
Style

- テーピング品は、包装数量単位で、ご注文ください。
- バルク（ストレート、フォーミング）品は、200本を単位に整数倍で、ご注文ください。

- ★For taped parts, please order per package multiple.
- ★For loose parts (straight or formed lead type), order by any multiple of SPQ/bag.

包装方法 / Packaging Style

つづら折り方式 Ammo Pack		L	H	T
		330±7	330±7	45±5
		330±7	330±7	50±5
		330±7	330±7	55±5

但しMMTはL=330±7、H=355±7、T=45±5となります。

MMT: L=330±7、H=355±7、T=45±5

リール方式はStyle1となります。
詳細はお問い合わせ下さい。
Reel packing available in Style1.
Please contact NISSEI for detailed assistance.

NISSEI 自動挿入用テーピング仕様 SPECIFICATIONS OF TAPING FOR AUTOMATIC INSERTION

●CHAタイプテーピング寸法

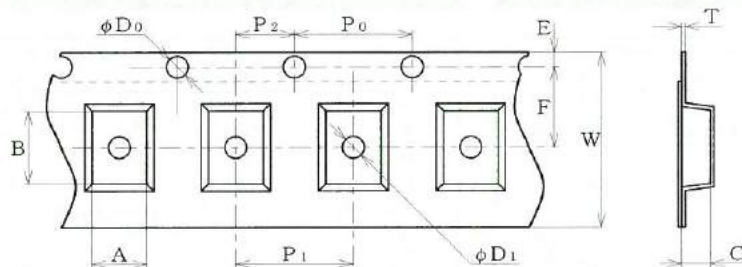

WV	Size	Cap	A	B	C	W	F	E	T	P ₀	P ₁	P ₂	φD ₀	φD ₁
16Vdc	20125	101~682	1.45±0.1	2.3±0.1	1.05±0.1	8.0±0.2	3.5±0.05	17.5±0.1	0.25±0.05	4.0±0.1	4.0±0.1	2.0±0.05	1.5±8 ¹	1.0±0.1
		822, 103	1.55±0.1	2.3±0.1	1.3±0.1	8.0±0.2	3.5±0.05	17.5±0.1	0.25±0.05	4.0±0.1	4.0±0.1	2.0±0.05	1.5±8 ¹	1.0±0.1
	3216	123~223	1.9±0.1	3.5±0.1	1.1±0.1	8.0±0.2	3.5±0.05	17.5±0.1	0.25±0.05	4.0±0.1	4.0±0.1	2.0±0.05	1.5±8 ¹	1.1±0.1
		273, 333	1.9±0.1	3.5±0.1	1.3±0.1	8.0±0.2	3.5±0.05	17.5±0.1	0.25±0.05	4.0±0.1	4.0±0.1	2.0±0.05	1.5±8 ¹	1.1±0.1
	3225	393, 473	1.9±0.1	3.5±0.1	1.6±0.1	8.0±0.2	3.5±0.05	17.5±0.1	0.25±0.05	4.0±0.1	4.0±0.1	2.0±0.05	1.5±8 ¹	1.1±0.1
		563~823	2.8±0.1	3.5±0.1	1.8±0.1	8.0±0.2	3.5±0.05	17.5±0.1	0.25±0.05	4.0±0.1	4.0±0.1	2.0±0.05	1.5±8 ¹	1.1±0.1
50Vdc	20125	101~272	1.55±0.1	2.3±0.1	1.05±0.1	8.0±0.2	3.5±0.05	17.5±0.1	0.25±0.05	4.0±0.1	4.0±0.1	2.0±0.05	1.5±8 ¹	1.0±0.1
		3216	332~103	1.9±0.1	3.5±0.1	1.3±0.1	8.0±0.2	3.5±0.05	17.5±0.1	0.25±0.05	4.0±0.1	4.0±0.1	2.0±0.05	1.5±8 ¹
	3225	123~183	2.8±0.1	3.5±0.1	1.3±0.1	8.0±0.2	3.5±0.05	17.5±0.1	0.25±0.05	4.0±0.1	4.0±0.1	2.0±0.05	1.5±8 ¹	1.1±0.1
		223, 273	2.8±0.1	3.5±0.1	1.8±0.1	8.0±0.2	3.5±0.05	17.5±0.1	0.25±0.05	4.0±0.1	4.0±0.1	2.0±0.05	1.5±8 ¹	1.1±0.1
	4833	333, 393	2.8±0.1	3.5±0.1	2.3±0.1	8.0±0.2	3.5±0.05	17.5±0.1	0.25±0.05	4.0±0.1	4.0±0.1	2.0±0.05	1.5±8 ¹	1.1±0.1
		473, 563	3.8±0.1	5.0±0.1	1.6±0.1	12.0±0.2	5.5±0.05	17.5±0.1	0.25±0.05	4.0±0.1	8.0±0.1	2.0±0.05	1.5±8 ¹	1.7±0.1
	6041	683, 823	3.8±0.1	5.0±0.1	1.9±0.1	12.0±0.2	5.5±0.05	17.5±0.1	0.25±0.05	4.0±0.1	8.0±0.1	2.0±0.05	1.5±8 ¹	1.7±0.1
		104	3.8±0.1	5.0±0.1	2.2±0.1	12.0±0.2	5.5±0.05	17.5±0.1	0.25±0.05	4.0±0.1	8.0±0.1	2.0±0.05	1.5±8 ¹	1.7±0.1
	6041	124	4.55±0.1	6.45±0.1	2.0±0.1	12.0±0.2	5.5±0.05	17.5±0.1	0.3±0.05	4.0±0.1	8.0±0.1	2.0±0.05	1.5±8 ¹	1.7±0.1
		154, 184	4.55±0.1	6.45±0.1	2.6±0.1	12.0±0.2	5.5±0.05	17.5±0.1	0.3±0.05	4.0±0.1	8.0±0.1	2.0±0.05	1.5±8 ¹	1.7±0.1
		224	4.55±0.1	6.45±0.1	3.0±0.1	12.0±0.2	5.5±0.05	17.5±0.1	0.3±0.05	4.0±0.1	8.0±0.1	2.0±0.05	1.5±8 ¹	1.7±0.1

●CHAタイプリール寸法

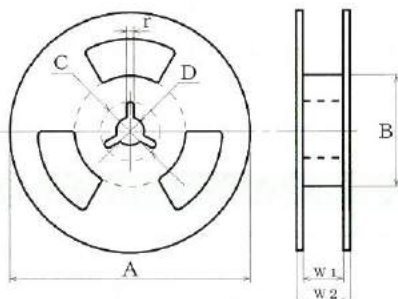

WV	Size	Cap	A	B	C	D	r	W ₁	W ₂
16Vdc	20125	101~103	180±8	60±1.0	21±0.8	13±0.2	2.0±0.5	9.0±0.5	11.4±1.0
	3216	123~473	180±8	60±1.0	21±0.8	13±0.2	2.0±0.5	9.0±0.5	11.4±1.0
	3225	563~104	180±8	60±1.0	21±0.8	13±0.2	2.0±0.5	9.0±0.5	11.4±1.0
50Vdc	20125	101~272	180±8	60±1.0	21±0.8	13±0.2	2.0±0.5	9.0±0.5	11.4±1.0
	3216	332~103	180±8	60±1.0	21±0.8	13±0.2	2.0±0.5	9.0±0.5	11.4±1.0
	3225	123~393	180±8	60±1.0	21±0.8	13±0.2	2.0±0.5	9.0±0.5	11.4±1.0
	4833	473~104	330±2.0	80±1.0	21±0.8	13±0.2	2.0±0.5	13.4±0.5	17.4±1.0
	6041	124~224	330±2.0	80±1.0	21±0.8	13±0.2	2.0±0.5	13.4±0.5	17.4±1.0



ご使用の際は必ず、品名毎に仕様書をお求めいただき、仕様書に規定した範囲で
ご使用下さい。

仕様書及び当注意事項の範囲を超えて使用しますと、ショート、オープン、発煙、
発火に至る場合があります。定格の範囲内であることを確認をお願い致します。
なお、仕様書に記載のない項目、不明な内容については、必ずお問い合わせ下さ
い。

また、生命に影響を与える可能性がある装置、機器にご使用される場合は、必ず
お問い合わせ下さい。

For use of any type of capacitor, you are recommended to obtain individual
specification in advance and use it within the limits specified thereby.
Use beyond such limits may lead to failures like short/open circuiting,
smoking or even combustion.

For characteristics not clear or unlisted in our specification, please feel
free to come to us.

Especially for life-affecting equipment, you are requested to ask for our
council.

温度による電圧軽減について / Voltage Derating versus Temperature

●コンデンサを高温で使用すると熱劣化によりコンデンサ寿命が低下します。
従いまして、高温でご使用の場合は、下記のグラフに示すように使用電圧を軽
減してご使用下さい。

★When using capacitors at temperature higher than the normally specified
maximum temperature, it is necessary to reduce the working voltage as
shown in the figures below.

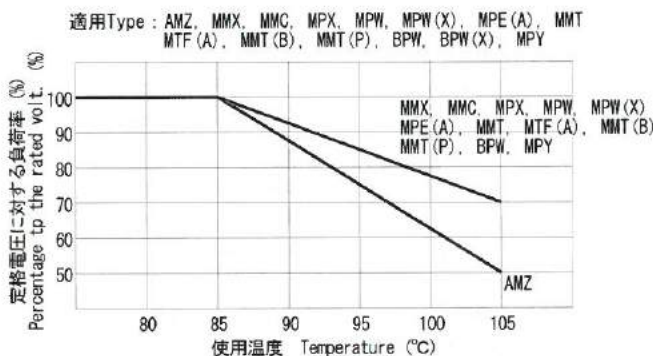

交流回路での使用について / Capacitors for Use in AC Circuit

(1) DC定格品を交流回路で使用する場合

●商用周波数 (50、60Hz) で使用する場合は下記の電圧以下でご使用下さい。

●注意 : DC定格電圧品は電源の一次側では使用しないでください。

●DCバイアス分を含む場合は、その波形の波高値 (ピーク電圧Vo-p) が定格
電圧以下となる様ご使用下さい。

(1) Permissible AC Voltage versus DC Rated Voltage

★When using a capacitor specified by DC rated voltage at commercial power
frequency (50Hz,60Hz), the permissible AC voltage is shown in the table
below.

CAUTION: The capacitor of DC rating should not be used at the primary side
of power supplies.

★If DC bias contained, Vo-p should not exceed the DC voltage.

商用周波数での交流許容電圧 (Vrms) / Permissible AC voltage rated (Vrms)

直流定格電圧 (Vdc) DC rated voltage (Vdc)	AHS	AMZ	ANR	MMC	MMX	MMT MMT(A)	MMT(B)	APS	MPE	MPX, MPW BPW	MMB(A)
35											25
50	40	40				30	30				
63						40	30				40
100	75	75		63		63	63	75			
250		125		125	125	125	125	125	125		
400		200		200	200			200	200		
450				200	200				200	150	
630				250	250				250	200	
800									250		
1000			300	400					300		
1250				500					400		
1600									500		

(2) 許容電流

1) 正弦波の場合

●正弦波で使用する場合、タイプ別に示した周波数に対する許容電流特性の許容
電流値 (Arms) 以下でご使用下さい。
許容値を超えて使用しますと、コンデンサの自己発熱により劣化、損傷の危険
があります。

(2) Permissible Current

1) Sine Wave

★Capacitors should be used within the limits of permissible current (Arms)
shown in the table for permissible current versus frequency.
If used in excess of permissible value, the capacitor may be deteriorated
and damaged by its self-heating.



2) 正弦波以外の場合

- 正弦波以外で使用する場合は、その実効電流値が周波数に対する許容電流特性の範囲内であり、かつピーク電流はタイプ別に示したコンデンサの許容ピーク電流値以下でご使用下さい。
- 規定値を超える条件下での急激な充放電は、コンデンサの特性変化や破壊につながりますので行わないで下さい。なお、実使用に当たっては、電流波形、コンデンサの温度上昇等をご確認の上、お問い合わせ下さい。

(3) 使用温度範囲について

- コンデンサの使用温度は、コンデンサの表面温度（周囲温度）+（自己発熱による温度上昇）+（他熱源からの熱輻射による温度上昇）で規定されます。交流や高周波回路で使用すると、コンデンサに流れる電流により、自己発熱を起し、自己発熱が大きいとコンデンサが劣化したり熱破壊の危険性があります。ご使用の際は、下表の自己温度上昇既定値及び使用温度範囲内であることをご確認下さい。

コンデンサの種類 Type of capacitor	自己温度上昇 Self temperature rise	品種 Type codes	コンデンサの種類 Type of capacitor	自己温度上昇 Self temperature rise	品種 Type codes
ポリエステルコンデンサ Polyester capacitor	15°C以内 Within 15°C	AMZ	メタライズドポリエステルコンデンサ Metallized polyester capacitor	15°C以内 Within 15°C	MMC, MMX, MMD MML, MMT, MTF MMT(B)
ポリプロピレンコンデンサ Polypropylene capacitor	10°C以内 Within 10°C	APS(A)	メタライズドポリプロピレンコンデンサ Metallized polypropylene capacitor	10°C以内 Within 10°C	MPE
				15°C以内 Within 15°C	MPX, MPW, MPW(X) MPE(A), BPW, BPW(X)
ポリフェニレンスルフィドコンデンサ Polyphenylene sulfide capacitor	15°C以内 Within 15°C	AHS	メタライズドポリフェニレンスルフィドコンデンサ Metallized polyphenylene sulfide capacitor	15°C以内 Within 15°C	CHA

(4) うなり音の発生

- コンデンサを交流回路に使用したとき、異極間に発生するクーロン力によって、誘電体であるフィルムが機械的振動を起し、うなり音を発生する場合があります。コンデンサの電気特性は問題ありませんが、ご使用上問題ないかご確認願います。

2) Non-Sine Wave

- ★When in use for non-sine wave, its effective current should be kept below the permissible current against frequency and, also, its peak current be below the capacitor's permissible peak current.
- ★Charging and discharging under conditions in excess of specifications should be avoided because it may lead to deterioration of performance capability and even to destruction of the capacitor. In application, you are recommended to ascertain current waves, capacitor heat generation, etc. and then consult with NISSEI.

(3) Operating temperature range

- ★The operating temperature of a capacitor is defined with ambient temperature + self-heating temperature rise + temperature rise due to thermal radiation from other heat sources. When using capacitors in AC conditions or in high frequency circuits, capacitors will generate heats due to the flowing current. In case of high self-heating, a capacitor shall be placed at risk for thermal breakdown or deterioration of the capacitor.
So, when using capacitors, please make sure that you requirements are within the limit of self-heating temperature rise and of operating temperature range.

(4) Mechanical Resonance

- ★Using under AC voltage results in the possibility of micro mechanical vibration of dielectric film driven by coulomb force producing thereby beat sounds (hum). Extensive test results have shown that this mechanical vibration in no way affects the electrical performance of the capacitor. However, it is highly recommended to check by yourself if this phenomenon could be the claim in the market or not.

時定数等シビアな回路にご使用の場合 / Capacitance Stability

- コンデンサはその環境条件によって特性変化があります。一般のご使用状況下も空気中の湿気が浸透し、若干の容量変化が起こります。この容量変化は誘電体によって異なりますので、時定数回路等には、ポリプロピレンフィルムを誘電体としたAPS、MPEタイプ、またはポリフェニレンスルフィドフィルムを誘電体としたAHS、CHAタイプをご使用下さい。

- ★Although film capacitors are highly stable in terms of maintaining capacitance value, in certain critical applications such as RC time constant circuits, extra care in capacitor selection is recommended. Since the greatest cause of capacitance drift is moisture ingress, in critical applications, NISSEI recommends that capacitor types using polypropylene (such as APS, MPE), polyphenylene sulfide (AHS, CHA) as the dielectric film to be used in place of straight polyester film types.



はんだ付け作業について / Soldering resistance

(1) リード線タイプのはんだ付け

- 1) はんだコテおよびはんだ槽を用いて、コンデンサのはんだ付けを行う場合、コンデンサのリード線、および外装部より、コンデンサ内部に熱が伝導されます。このため次の基準を厳守し作業を行って下さい。なお、2回ディップされる場合は、1回目のディップが終了し、コンデンサ本体が常温に戻ってから作業を行って下さい。(自然放置約30分)
- 2) チップ部品との混載によるはんだ付けの場合は、条件が異なりますのでご相談下さい。

(1) Soldering for leaded components

- 1) Because soldering allows for the thermal conduction through the capacitor lead wires into the capacitor itself, extreme care should always be taken in maintaining the proper soldering parameters. The figures below give examples of recommended time/temperature soldering profiles for use with plastic film capacitors. When dipped twice in the solder bath, the second dipping must be after the capacitor surface temperature comes down to the room temperature (around 30 minutes by natural cooling).
- 2) In the case of soldering conditions shall differ from the normal conditions. Please contact NISSEI for assistance.

1. はんだコテ使用 When use with soldering iron

ポリエステルフィルムコンデンサ Polyester film capacitors	コテ先温度 350°C以下、はんだ付け時間 5秒以内 Iron tip temperature: Less than 350°C, Soldering time: Within 5 seconds
ポリプロピレンフィルムコンデンサ Polypropylene film capacitor	コテ先温度 350°C以下、はんだ付け時間 3秒以内 Iron tip temperature: Less than 350°C, Soldering time: Within 3 seconds

2. はんだ槽使用 For the use in solder bath

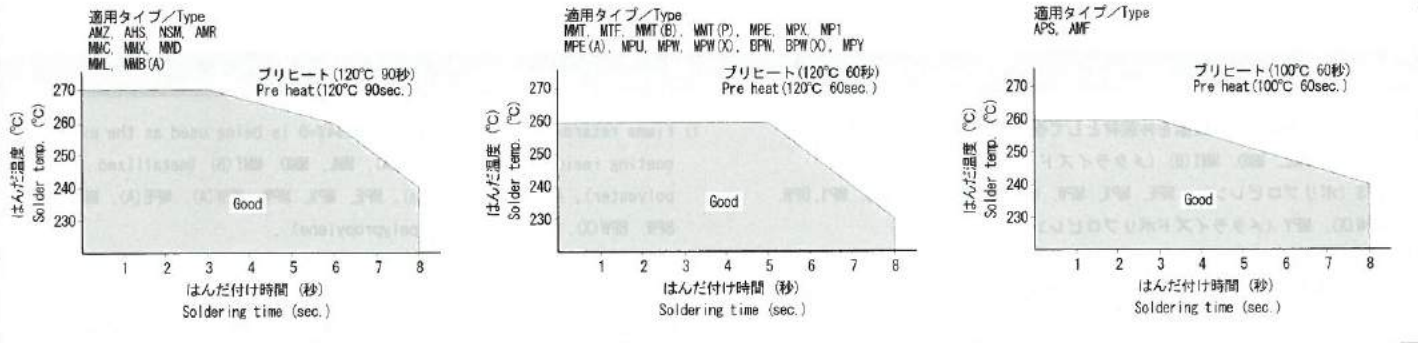

(1) CHAタイプのはんだ付け

- 1) リフローによる取り付け (右図の範囲を超えないこと)
 - ① 予熱は165°Cまたはそれ以下で、加熱時間は70秒以内にしてください。
 - ② 230°Cを超える区間は、30秒以内にしてください。
 - ③ 最高温度は、260°C以下にしてください。
 - ④ 規定温度は、コンデンサ素子の表面温度となります。

(1) Soldering for CHA type capacitor

- 1) Reflow soldering (Don't exceed the range of the reflow conditions specified right.)
 - ① Preheating shall be 165°C or less., heating time shall be within 70 seconds.
 - ② Do not apply soldering longer than 30 sec in the section where the temperature exceeds 230°C.
 - ③ Absolute maximum temperature shall be 260°C or less.
 - ④ The specified temperatures are the surface temperature of the capacitors.

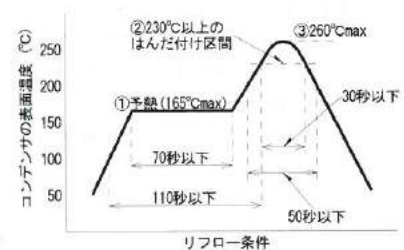

- 2) フローによる取り付け (右図の範囲を超えないこと)
 - ① 予熱は150°Cまたはそれ以下で、加熱時間は70秒以内にしてください。
 - ② はんだ付け区間の時間は、5秒以内にしてください。
 - ③ 最高温度は、250°C以下にしてください。

- 2) Flow soldering (Don't exceed the range of the reflow conditions specified right.)
 - ① Preheating shall be 165°C or less., soldering time shall be within 70 seconds.
 - ② Do not apply soldering longer than 5 sec in the section where the temperature 250°C.
 - ③ Absolute maximum temperature shall be 250°C or less.

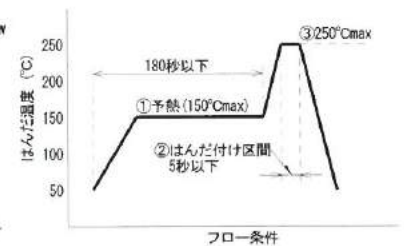

3) はんだコテによる取り付け

- ① はんだコテが直接コンデンサ素子に触れないように取り付けて下さい。
- ② 基板側に供給したはんだを溶融させ、コンデンサ素子に馴染ませる方法で取り付けて下さい。
- ③ 溶けたはんだがコンデンサ素子に馴染んだ時、速やかにはんだコテを取り去って下さい。
- ④ はんだコテ先温度と時間は、最大270°C、4秒を限度とし、最小限の溶融量で取り付けて下さい。
- ⑤ 取り外したコンデンサの再使用はお避け下さい。

3) Iron soldering

- ① Do not contact the capacitor element with the iron directly.
- ② Melt the solder on the PC board and then put the capacitor on it.
- ③ The iron must be taken away as soon as the solder has taken on the capacitor.
- ④ The tip of the soldering iron shall be 270°C max., 4 sec. max.
- ⑤ Please avoid the reuse of the product which is soldered on PC board once.



溶剤の使用について / Usage of solvent

●洗浄の目的で使用する溶剤は、アルコール系（イソプロピルアルコール等）を使用し、速やかに洗浄及び乾燥を行って下さい。

★When cleaning PC board, the use of alcohol type solvents (isopropyl alcohol, etc.) is recommended. PC boards should be dried quickly after the cleaning process is completed.

コンデンサの取り扱いについて / Physical handling of capacitors

1) コンデンサ表面には、はんだコテやピンセット、エアドライバ及びシャーシのエッジなどの鋭利なものが強く接触しないよう、ご注意ください。ショートや断線の原因となる恐れがあります。

1) Do not apply to strongly to the capacitor sharp edges of chassis, air-drivers, tweezers, soldering irons and other tools used in the assembly of electronic circuit. Any strong physical contact with the capacitor could result in severe damage to the termination or dielectric causing either a short or open circuit.

2) コンデンサを固定する場合は、燃えにくい材料をご使用下さい。

2) When physically fixing the capacitors, use the flame retardant materials.

3) 保管は、室内で温度-10~+40℃、相対湿度75%以下で、急激な温度変化、直射日光、腐食性ガスのある雰囲気は、避けて下さい。

3) Storing conditions shall be inside the room at -10~+40℃ with RH 75% or less. Avoid steep temperature changes, atmosphere, direct exposure to the sun beams or corrosive atmosphere capacitors stored more than a year shall be examined for their electric characteristics and solderability before use.

また、1年以上放置したものについては、電気特性及び、はんだ付け性を確認してご使用下さい。

4) サンプルとしてお求めになったコンデンサは、市販セットに使用しないで下さい。

4) Capacitors obtained as sample shall not be used in the field.

難燃性他について / Flame resistance (retardant) and others

1) UL94V-0取得の難燃性樹脂を外装材として使用するタイプには、MMX, MMC, MMB(A), MML, NMD, MNT(B) (メタライズドポリエステル)、APS (ポリプロピレン)、MPE, MPX, MPW, MPW(X), MPE(A), MPU, MP1, BPW, BPW(X), MPY (メタライズドポリプロピレン) AHS (ポリフェニレンスルフィド) があります。

1) Flame retardant resin approved to UL94V-0 is being used as the exterior coating resin in MMX, MMC, MMB(A), MML, NMD, MNT(B) (metallized polyester), APS (Polypropylene), MPE, MPX, MPW, MPW(X), MPE(A), MPU, MP1, BPW, BPW(X), MPY (metallized polypropylene), AHS (polyphenylene sulfide) series.

2) 特定臭素系難燃材及びモントリオール議定書で規制されているオゾン層破壊物質は、全製品の全工程で一切使用しておりません。

2) Specific bromic flame retardant and Ozone depleting substances limited by Montreal protocol are not being used in the manufacturing process of pur products.

3) ご使用にあたっては、使用上の注意事項 (9~16) のご確認と、仕様書などをお求め願ひ、仕様書の範囲内でのご使用をお願いします。

3) When using these capacitors, limits shown in the Instructions for Handling on pages 9 to 16 as well as in technical specifications shall not be exceeded. If in doubt, please consult us.

また、日本電子機械工業会から「電子機器用固定プラスチックフィルムコンデンサ使用上の注意事項ガイドライン」EIAJ RCR-2350(1995年3月制定)が技術レポートとして出ていますので、安全設計にお役立て下さい。

Electronic Industries Association of Japan published "Guideline of notabilia for fixed plastic film capacitors for use in electronic equipment" - EIAJ RCR-2350 (established in March, 1995) as technical reports. We recommended to make use of this publication for your safety designing.



コンデンサに流れる電流は下記の許容電流ピーク値以内で、且つ実効値電流も各タイプ別に示した周波数に対する許容電流特性値以下でご使用ください。

- 単発ピーク電流は、電源ON/OFF時の突入電流などの非繰り返し電流を想定した充放電試験の値であり、10,000回を限度とします。
- 連続ピーク電流は、繰り返しのある電流値です。電流による自己発熱にご注意下さい。
- また、電流値が下記の値を超える場合や、単発ピーク電流が10,000回を超える場合はご相談ください。

★Current applied to the capacitor should be restrained to permissible peak currents specified here. Effective current should also be limited to permissible current values against frequency per capacitor type.

- Single Peak Current obtained in charge and discharge tests applies non-continual pulses from on/off switches and is applicable up to 10,000 separate pulses.
- Continual Peak Current applies repetitive frequent pulses. Beware of self-heating of the capacitor.
- In case operating current may exceed the below values or pulses may exceed 10,000 times, please seek our consultation.

◆Type MMX

容量記号	静電容量 (μF)	250Vdc		400Vdc		450Vdc		630Vdc	
		単発 (Ao-p)	連続 (Ao-p)	単発 (Ao-p)	連続 (Ao-p)	単発 (Ao-p)	連続 (Ao-p)	単発 (Ao-p)	連続 (Ao-p)
102	0.0010	0.20	0.11	0.15	0.06			0.26	0.08
122	0.0012	0.24	0.13	0.18	0.07			0.31	0.09
152	0.0015	0.30	0.16	0.23	0.09			0.39	0.12
182	0.0018	0.36	0.19	0.27	0.10			0.47	0.14
222	0.0022	0.36	0.19	0.33	0.10			0.57	0.14
272	0.0027	0.41	0.23	0.41	0.13			0.70	0.17
332	0.0033	0.50	0.28	0.50	0.16			0.85	0.21
392	0.0039	0.59	0.33	0.59	0.17			1.01	0.22
472	0.0047	0.71	0.40	0.71	0.20			1.22	0.27
562	0.0056	0.68	0.30	0.84	0.24			1.45	0.32
682	0.0068	0.82	0.36	1.02	0.29			1.76	0.38
822	0.0082	0.99	0.43	1.23	0.35			2.12	0.46
103	0.010	1.21	0.53	1.50	0.32			2.59	0.49
123	0.012	1.45	0.64	1.80	0.38			3.11	0.59
153	0.015	1.18	0.79	2.25	0.48			3.89	0.74
183	0.018	2.17	0.67	2.70	0.57			4.66	0.89
223	0.022	2.66	0.82	3.30	0.70			5.70	1.09
273	0.027	3.26	1.00	4.05	0.86			6.99	1.33
333	0.033	3.98	1.22	4.95	0.77			8.55	1.63
393	0.039	4.71	1.45	5.85	0.91			10.10	1.93
473	0.047	5.67	1.74	7.05	1.10			12.17	2.32
563	0.056	6.76	2.08	8.40	1.30			10.75	1.51
683	0.068	8.21	2.52	10.20	1.58			13.06	1.83
823	0.082	9.90	3.04	12.30	1.91			15.74	2.21
104	0.10	12.07	3.71	15.00	2.33	15.00	2.33	19.20	2.70
124	0.12	14.48	4.45	12.96	1.72	12.96	1.72	23.04	3.23
154	0.15	18.11	5.56	16.20	2.15	16.20	2.15	28.80	4.04
184	0.18	13.50	3.34	19.44	2.58	19.44	2.58	34.56	4.85
224	0.22	16.50	4.08	23.76	3.15	23.76	3.15	42.24	5.93
274	0.27	20.25	5.00	29.16	3.87	29.16	3.87	27.27	3.81
334	0.33	24.75	6.12	35.64	4.73	35.64	4.73	33.33	4.66
394	0.39	21.26	4.45	42.12	5.59	42.12	5.59	39.39	5.51
474	0.47	25.62	5.36	50.76	6.74	50.76	6.74	47.47	6.64
564	0.56	30.52	6.39	34.44	4.54	34.44	4.54	56.56	7.91
684	0.68	37.06	7.76	41.82	5.51	41.82	5.51	68.68	9.60
824	0.82	32.55	7.15	50.43	6.64	50.43	6.64	48.38	6.95
105	1.0	39.70	8.72	61.50	8.10	61.50	8.10	59.00	8.47
125	1.2	47.64	10.47	73.80	9.72	73.80	9.72	70.80	10.17
155	1.5	59.55	13.08	55.50	7.56	55.50	7.56	88.50	12.71
185	1.8	47.52	9.88	66.60	9.07	66.60	9.07	106.20	15.25
225	2.2	58.08	12.08	81.40	11.08	81.40	11.08	129.80	18.64
275	2.7	71.28	14.83	99.90	13.60	99.90	13.60		
335	3.3	87.12	18.12	122.10	16.62	122.10	16.62		
395	3.9	102.95	21.42	144.30	19.65	144.30	19.65		
475	4.7	124.08	25.81	173.90	23.68	173.90	23.68		
565	5.6	103.60	22.44						
685	6.8	125.80	27.25						
825	8.2	151.70	32.86						
106	10	185.00	40.07						

◆Type MMT

容量記号	静電容量 (μF)	50Vdc		63Vdc		100Vdc		250Vdc	
		単発 (Ao-p)	連続 (Ao-p)	単発 (Ao-p)	連続 (Ao-p)	単発 (Ao-p)	連続 (Ao-p)	単発 (Ao-p)	連続 (Ao-p)
103	0.010	0.36	0.14	0.42	0.14	0.69	0.37	1.21	0.53
123	0.012	0.43	0.17	0.50	0.17	0.83	0.45	1.45	0.64
153	0.015	0.54	0.21	0.62	0.21	1.04	0.45	1.81	0.79
183	0.018	0.65	0.25	0.75	0.25	1.24	0.54	2.17	0.87
223	0.022	0.79	0.31	0.91	0.31	1.52	0.66	2.66	0.82
273	0.027	0.97	0.38	1.12	0.38	1.86	0.82	3.26	1.00
333	0.033	1.19	0.46	1.37	0.46	2.28	1.00	3.98	1.22
393	0.039	1.40	0.55	1.62	0.55	2.69	0.62	4.71	1.45
473	0.047	1.69	0.66	1.95	0.66	3.24	0.75	5.67	1.74
563	0.056	2.02	0.78	2.32	0.78	3.86	0.89	6.76	2.08
683	0.068	2.45	0.95	2.82	0.95	4.69	0.97	8.21	2.52
823	0.082	2.95	1.15	3.40	1.15	5.66	1.17	9.90	3.04
104	0.10	3.60	1.40	4.15	1.40	6.90	1.43	12.07	3.71
124	0.12	4.32	1.68	4.98	1.68	8.28	1.72	14.48	4.45
154	0.15	5.40	2.10	6.23	2.10	10.35	2.14	18.11	5.56
184	0.18	6.48	2.52	7.47	2.52	12.42	2.57	13.50	3.34
224	0.22	7.92	3.08	9.13	3.08	15.18	3.15	16.50	4.08
274	0.27	9.72	3.78	11.21	3.78	18.63	3.86		
334	0.33	11.88	4.62	13.70	4.62	22.77	4.72		
394	0.39	14.04	5.46	16.19	5.46	26.91	5.58		
474	0.47	16.92	6.58	19.51	6.58	32.43	6.72		
564	0.56	20.16	7.84	23.24	7.84	38.64	8.01		
684	0.68	24.48	9.52	28.22	9.52	46.92	9.72		
824	0.82	29.52	11.48	34.03	11.48	56.58	11.72		
105	1.0	36.00	14.00	41.50	14.00	69.00	14.30		
125	1.2	24.00	9.60	27.60	9.60				
155	1.5	30.00	12.00	34.50	12.00				
185	1.8	36.00	14.40	41.40	14.40				
225	2.2	44.00	17.60	50.60	17.60				
275	2.7	54.00	21.60	62.10	21.60				
335	3.3	66.00	26.40	75.90	26.40				

◆Type MMB(A)

容量記号	静電容量 (μF)	35Vdc		63Vdc	
		単発 (Ao-p)	連続 (Ao-p)	単発 (Ao-p)	連続 (Ao-p)
475	4.7	72.85	26.54	82.25	31.85
106	10	115.00	44.59	135.00	53.51
226	22	202.40	51.77	231.00	62.13

●この許容電流値は単位時間当たりの電圧勾配 (dv/dt) により求めた値で、
 $I(Ao-p) = C(\mu F) \times dv/dt (V/\mu s)$ で算出されます。
 詳しくは仕様書をご確認ください。

■Permissible current values below is computed as $I=C \times dv/dt (Ao-p)$
 For further details, refer to our respective Specifications.

ご使用に関しては上記の許容ピーク電流値以内とし、実効値電流 (Arms) も各タイプ別に示した周波数に対する許容電流特性値以下でご使用ください。
 Operating conditions should not exceed the above peak current should not go beyond the permissible current and effective current (Arms) should not exceed the permissible current against frequency per capacitor type.



◆Type MMC

容量記号	静電容量 (μF)	100Vdc		250Vdc		400/450Vdc		630Vdc		1000Vdc		1250Vdc	
		単発 (Ao-p)	連続 (Ao-p)	単発 (Ao-p)	連続 (Ao-p)	単発 (Ao-p)	連続 (Ao-p)	単発 (Ao-p)	連続 (Ao-p)	単発 (Ao-p)	連続 (Ao-p)	単発 (Ao-p)	連続 (Ao-p)
102	0.0010			0.11	0.11	0.15	0.11	0.26	0.11	0.29	0.25	0.35	0.25
122	0.0012			0.10	0.10	0.18	0.10	0.31	0.13	0.35	0.30	0.42	0.30
152	0.0015			0.13	0.13	0.23	0.13	0.39	0.17	0.44	0.33	0.53	0.33
182	0.0018			0.15	0.15	0.27	0.15	0.47	0.20	0.53	0.40	0.64	0.40
222	0.0022			0.17	0.13	0.33	0.13	0.57	0.17	0.65	0.49	0.78	0.49
272	0.0027			0.20	0.16	0.41	0.16	0.70	0.21	0.79	0.60	0.96	0.60
332	0.0033			0.25	0.19	0.50	0.19	0.85	0.25	0.97	0.73	1.17	0.73
392	0.0039			0.29	0.18	0.59	0.18	1.01	0.27	1.15	0.87	1.38	0.87
472	0.0047			0.35	0.22	0.71	0.22	1.22	0.33	1.38	1.04	1.66	1.04
562	0.0056			0.42	0.26	0.84	0.26	1.45	0.39	1.65	1.24	1.98	1.24
682	0.0068			0.51	0.32	1.02	0.32	1.76	0.48	2.00	1.15	2.41	1.15
822	0.0082			0.62	0.39	1.23	0.39	2.12	0.57	2.41	1.39	2.94	1.39
103	0.010			0.75	0.47	1.50	0.47	1.92	0.38	2.94	1.69	3.72	1.69
123	0.012			0.90	0.50	1.80	0.56	2.30	0.46	3.53	2.03	4.41	2.03
153	0.015			1.13	0.63	2.25	0.63	2.88	0.57	4.41	2.54	5.56	2.54
183	0.018			1.35	0.67	2.70	0.67	3.46	0.68	5.29	3.04	6.47	3.04
223	0.022			1.65	0.68	3.30	0.81	4.22	0.84	6.47	3.72	8.20	3.72
273	0.027			2.03	0.84	4.05	1.00	5.18	1.03	7.94	4.41	10.00	4.41
333	0.033	1.32	0.83	2.48	0.86	4.95	1.22	6.34	1.25	9.00	5.17	12.24	5.17
393	0.039	1.56	0.86	2.93	1.01	4.21	0.86	7.49	1.48	7.43	2.93	6.79	2.11
473	0.047	1.88	0.89	3.53	1.22	5.08	1.03	9.02	1.79	8.95	3.53	8.18	2.54
563	0.056	2.24	1.06	4.20	1.48	6.05	1.23	5.66	1.12	10.67	4.20	7.73	2.72
683	0.068	2.72	1.09	5.10	1.29	7.34	1.50	6.87	1.36	12.95	5.10	9.38	3.30
823	0.082	3.28	1.31	6.15	1.56	8.86	1.80	8.28	1.64	15.62	6.15	11.32	3.98
104	0.10	4.00	1.60	7.50	1.90	10.80	2.20	10.10	2.00	19.05	7.50	13.80	4.85
124	0.12	4.80	1.92	9.00	2.28	7.38	1.44	12.12	2.40	18.56	5.76	16.56	5.32
154	0.15	6.00	2.40	11.25	2.85	9.23	1.80	15.15	3.00	20.70	7.20	20.70	7.28
184	0.18	7.20	2.88	9.81	2.16	11.07	2.16	18.18	3.80	24.84	8.64	24.84	8.73
224	0.22	8.80	3.52	11.99	2.64	13.53	2.64	22.22	4.40	30.36	10.56	30.36	10.67
274	0.27	10.80	4.32	14.72	3.24	16.51	3.24	15.93	3.24	37.26	12.96		
334	0.33	13.20	5.28	17.99	3.96	20.30	3.96	19.47	3.96	35.15	11.72		
394	0.39	15.60	6.24	11.90	2.54	23.99	4.88	23.01	4.88	41.54	13.85		
474	0.47	18.80	7.52	14.34	3.06	28.91	5.64	27.73	5.64	50.06	16.69		
564	0.56	19.04	6.16	17.08	3.64	20.72	4.48	33.04	6.72				
684	0.68	23.12	7.48	20.74	4.42	25.16	5.44	40.12	8.16				
824	0.82	27.88	9.02	25.01	5.33	30.34	6.56	37.72	6.56				
105	1.0	34.00	11.00	30.50	6.50	37.00	8.00	46.00	8.00				
125	1.2	22.80	7.80	36.60	7.80	44.40	9.60	55.20	9.60				
155	1.5	28.50	9.75	45.75	9.75	44.25	9.00	69.00	12.00				
185	1.8	34.20	11.76	33.30	7.20	53.10	9.00	82.80	14.40				
225	2.2	41.80	14.30	40.70	8.80	64.90	11.00	101.20	17.60				
275	2.7	31.32	10.80	49.95	10.80	79.65	13.50						
335	3.3	38.28	13.20	61.05	13.20	97.35	16.50						
395	3.9	45.24	15.60	72.15	15.60	115.05	19.50						
475	4.7	54.52	18.80	86.95	18.80	138.65	23.50						
565	5.6			81.20	16.80								
685	6.8			98.60	20.40								
825	8.2			118.90	24.60								
106	10			145.00	30.00								

◆Type MML

容量記号	静電容量 (μF)	125Vac	
		単発 (Ao-p)	連続 (Ao-p)
103	0.010	1.00	0.88
123	0.012	1.20	1.06
153	0.015	1.50	1.16
183	0.018	1.80	1.40
223	0.022	2.20	1.71
273	0.027	2.70	1.76
333	0.033	3.30	2.16
393	0.039	3.90	2.55
473	0.047	4.70	3.07
563	0.056	5.60	3.66
683	0.068	6.80	4.44
823	0.082	8.20	5.36
104	0.10	10.00	6.53
124	0.12	12.00	7.84
154	0.15	15.00	9.80
184	0.18	18.00	11.75
224	0.22	22.00	14.37
274	0.27	27.00	10.85
334	0.33	33.00	13.26
394	0.39	39.00	15.67
474	0.47	47.00	18.89
564	0.56	56.00	22.51
684	0.68	68.00	27.33
824	0.82	82.00	18.63
105	1.0	100.00	22.71
125	1.2	120.00	27.26
155	1.5	150.00	34.07
185	1.8	180.00	40.88
225	2.2	220.00	49.97
275	2.7	270.00	61.33
335	3.3	330.00	46.60
395	3.9	390.00	55.07
475	4.7	470.00	66.36

◆Type MMD

容量記号	静電容量 (μF)	125Vac		250Vac	
		単発 (Ao-p)	連続 (Ao-p)	単発 (Ao-p)	連続 (Ao-p)
103	0.010	1.00	0.47	1.00	0.47
123	0.012	1.20	0.50	1.20	0.56
153	0.015	1.50	0.63	1.50	0.71
183	0.018	1.80	0.67	1.80	0.95
223	0.022	2.20	0.68	2.20	1.03
273	0.027	2.70	0.84	2.70	1.13
333	0.033	3.30	0.86	3.30	1.39
393	0.039	3.90	1.01	3.90	1.54
473	0.047	4.70	1.22	4.70	1.97
563	0.056	5.60	1.46	5.60	1.12
683	0.068	6.80	1.77	6.80	1.36
823	0.082	8.20	1.31	8.20	1.64
104	0.10	10.00	1.60	10.00	2.00
124	0.12	12.00	1.92	12.00	2.40
154	0.15	15.00	2.40	15.00	3.00
184	0.18	18.00	2.88	18.00	3.60
224	0.22	22.00	3.52	22.00	4.40
274	0.27	27.00	2.48	27.00	2.97
334	0.33	33.00	3.04	33.00	3.63
394	0.39	39.00	3.59	39.00	4.29
474	0.47	47.00	4.32	47.00	5.17
564	0.56	56.00	5.15		
684	0.68	68.00	6.26		
824	0.82	82.00	4.67		
105	1.0	100.00	5.70		

●この許容電流値は単位時間当たりの電圧勾配 (dv/dt) により求めた値で、
 $I(Ao-p) = C(\mu F) \times dv/dt (V/\mu s)$ で算出されます。
 詳しくは仕様書をご確認ください。

■Permissible current values below is computed as $I=C \times dv/dt (Ao-p)$
 For further details, refer to our respective Specifications.

◆Type AMZ・APS・AHS・ANR・NSM

許容ピーク電流値(単発・連続)は200Ao-p
 Permissible peak current(Single/Continual)=200Ao-p

ご使用に関しては上記の許容ピーク電流値以内とし、実効値電流(Arms)も各タイプ別に示した周波数に対する許容電流特性値以下でご使用ください。
 Operating conditions should not exceed the above peak current should not go beyond the permissible current and effective current(Arms) should not exceed the permissible current against frequency per capacitor type.

◆Type MPE

容量記号	静電容量 (μF)	250Vdc		400/450Vdc		630Vdc	
		単発 (Ao-p)	連続 (Ao-p)	単発 (Ao-p)	連続 (Ao-p)	単発 (Ao-p)	連続 (Ao-p)
103	0.010	5.38	3.96	5.38	3.96	5.38	3.96
113	0.011	5.92	4.25	5.92	4.25	5.92	4.25
123	0.012	6.46	4.54	6.46	4.54	6.46	4.54
133	0.013	6.99	4.82	6.99	4.82	6.99	4.82
153	0.015	8.07	5.36	8.07	5.36	8.07	5.36
163	0.016	8.61	5.63	8.61	5.63	8.61	5.63
183	0.018	9.68	6.15	9.68	6.15	9.68	6.15
203	0.020	10.76	6.66	10.76	6.66	10.76	6.66
223	0.022	11.84	7.15	11.84	7.15	11.84	7.15
243	0.024	12.91	7.63	12.91	7.63	12.91	7.63
273	0.027	14.53	8.34	14.53	8.34	14.53	8.34
303	0.030	16.14	9.02	16.14	9.02	16.14	9.02
333	0.033	7.52	5.47	7.52	5.47	12.38	7.11
363	0.036	8.21	5.84	8.21	5.84	13.50	7.59
393	0.039	8.89	6.20	8.89	6.20	14.63	8.05
433	0.043	9.80	6.67	9.80	6.67	16.13	8.67
473	0.047	10.72	7.13	10.72	7.13	17.63	9.26
513	0.051	11.63	7.58	11.63	7.58	19.13	9.85
563	0.056	12.77	8.13	12.77	8.13	21.00	10.57
623	0.062	14.14	8.77	14.14	8.77	23.25	11.40
683	0.068	15.50	9.40	15.50	9.40	25.50	12.22
753	0.075	17.10	10.12	17.10	10.12	28.13	13.15
823	0.082	18.70	10.82	18.70	10.82	31.34	14.15
913	0.091	20.75	11.70	20.75	11.70	35.25	15.30
104	0.10	17.01	9.60	17.01	9.60	21.15	11.66
114	0.11	18.71	10.31	18.71	10.31	23.27	12.52
124	0.12	20.41	11.01	20.41	11.01	25.38	13.37
134	0.13	22.11	11.69	22.11	11.69	27.50	14.19
154	0.15	25.52	13.01	25.52	13.01	31.73	15.80
164	0.16	27.22	13.66	27.22	13.66	29.14	13.93
184	0.18	19.89	9.95	22.06	11.03	30.44	15.22
204	0.20	21.53	10.76	23.87	11.93	32.94	16.47
224	0.22	23.12	11.56	25.64	12.82	35.38	17.69
244	0.24	24.68	12.34	27.37	13.68	37.77	18.88
274	0.27	26.96	13.48	29.89	14.95	41.25	20.63
304	0.30	29.18	14.59	32.35	16.18	44.80	22.40
334	0.33	31.34	15.67	34.75	17.37	48.44	24.20
364	0.36	33.46	16.73	37.09	18.55	52.14	26.00
394	0.39	35.53	17.76	39.39	19.69	55.90	27.80
434	0.43	38.23	19.11	42.38	21.19	60.24	29.80
474	0.47	40.73	20.66	45.19	22.90	64.73	31.90
514	0.51	43.35	22.38	48.03	24.80	69.33	34.10
564	0.56	46.14	24.34	51.01	26.90	74.10	36.40
624	0.62	50.17	26.67	54.23	29.30	79.10	38.80
684	0.68	54.44	29.26	57.70	31.90	84.30	41.30
754	0.75	58.96	32.10	61.44	34.70	89.70	43.90
824	0.82	63.74	35.20	65.46	37.70	95.30	46.60
914	0.91	68.88	38.56	69.77	40.90	101.10	49.40
105	1.0	37.80	22.66	52.00	24.81	64.50	30.59
115	1.1	41.58	24.34	57.20	26.64	70.95	32.86
125	1.2	45.36	25.98	62.40	28.44	77.40	35.08
135	1.3	49.14	27.59	67.60	30.20	83.90	37.41
155	1.5	56.70	30.72	78.00	33.62	101.90	42.74
165	1.6	60.48	32.24	83.20	35.29	107.36	44.36
185	1.8	54.00	25.70	73.80	30.35	98.28	37.53
205	2.0	60.00	27.81	82.00	32.84	109.20	40.82
225	2.2	66.00	29.87	90.20	35.28	120.12	43.63
245	2.4	72.00	31.89	98.40	37.68	131.04	46.44
275	2.7	81.00	34.83	107.70	40.00	142.96	49.25
305	3.0	90.00	37.70	117.00	42.36	154.88	52.06
335	3.3	99.00	40.49	126.30	44.68	166.80	54.87
365	3.6	108.00	43.22	135.60	46.96	178.72	57.68
395	3.9	117.00	45.91	144.90	49.20	190.64	60.49
435	4.3	126.00	48.56	154.20	51.44	202.56	63.30
475	4.7	135.00	51.16	163.50	53.64	214.48	66.11
515	5.1	144.00	53.71	172.80	55.80	226.40	68.92
565	5.6	153.00	56.21	182.10	57.96	238.32	71.73
625	6.2	162.00	58.66	191.40	60.08	250.24	74.54
685	6.8	171.00	61.06	200.70	62.16	262.16	77.35
755	7.5	180.00	63.41	210.00	64.20	274.08	80.16
825	8.2	189.00	65.71	219.30	66.24	286.00	82.97
915	9.1	198.00	68.00	228.60	68.24	297.92	85.78
106	10	179.00	58.32	200.00	58.32	250.00	72.00

容量記号	静電容量 (μF)	800Vdc		1000Vdc		1250Vdc		1600Vdc	
		単発 (Ao-p)	連続 (Ao-p)	単発 (Ao-p)	連続 (Ao-p)	単発 (Ao-p)	連続 (Ao-p)	単発 (Ao-p)	連続 (Ao-p)
102	0.0010	7.84	3.92	7.84	3.92	7.84	3.92	7.84	3.92
112	0.0011	8.43	4.21	8.43	4.21	8.43	4.21	8.43	4.21
122	0.0012	8.99	4.50	8.99	4.50	8.99	4.50	8.99	4.50
132	0.0013	9.55	4.78	9.55	4.78	9.55	4.78	9.55	4.78
152	0.0015	10.63	5.32	10.63	5.32	10.63	5.32	10.63	5.32
162	0.0016	11.16	5.58	11.16	5.58	11.16	5.58	11.16	5.58
182	0.0018	12.19	6.10	12.19	6.10	12.19	6.10	12.19	6.10
202	0.0020	13.19	6.60	13.19	6.60	13.19	6.60	13.19	6.60
222	0.0022	14.17	7.09	14.17	7.09	14.17	7.09	14.17	7.09
242	0.0024	15.13	7.56	15.13	7.56	15.13	7.56	15.13	7.56
272	0.0027	16.55	8.34	16.55	8.34	16.55	8.34	16.55	8.34
302	0.0030	18.17	9.02	18.17	9.02	18.17	9.02	18.17	9.02
332	0.0033	8.78	4.39	8.78	4.39	8.78	4.39	8.78	4.39
362	0.0036	9.37	4.69	9.37	4.69	9.37	4.69	9.37	4.69
392	0.0039	9.95	4.98	9.95	4.98	9.95	4.98	9.95	4.98
432	0.0043	10.71	5.35	10.71	5.35	10.71	5.35	10.71	5.35
472	0.0047	11.45	5.72	11.45	5.72	11.45	5.72	11.45	5.72
512	0.0051	12.17	6.09	12.17	6.09	12.17	6.09	12.17	6.09
562	0.0056	12.99	6.49	12.99	6.49	12.99	6.49	12.99	6.49
622	0.0062	14.07	7.13	14.07	7.13	14.07	7.13	14.07	7.13
682	0.0068	15.33	7.66	15.33	7.66	15.33	7.66	15.33	7.66
752	0.0075	16.89	8.40	16.89	8.40	16.89	8.40	16.89	8.40
822	0.0082	18.14	9.07	18.14	9.07	18.14	9.07	18.14	9.07
912	0.0091	19.96	9.95	19.96	9.95	19.96	9.95	19.96	9.95
103	0.010	11.76	5.88	11.76	5.88	15.12	7.56	11.76	5.88
113	0.011	12.64	6.32	12.64	6.32	16.25	8.12	12.64	6.32
123	0.012	13.49	6.74	13.49	6.74	17.34	8.67	13.49	6.74
133	0.013	14.32	7.16	14.32	7.16	18.41	9.21	14.32	7.16
153	0.015	16.37	8.13	15.94	7.97	20.50	10.25	15.94	7.97
163	0.016	17.14	8.37	16.74	8.37	21.52	10.76	16.74	8.37
183	0.018	18.67	9.14	18.28	9.14	22.71	11.34	18.28	9.14
203	0.020	19.98	9.78	19.78	9.78	24.14	12.00	19.78	9.78
223	0.022	21.21	10.31	21.25	10.63	25.94	12.80	21.25	10.63
243	0.024	22.34	10.81	22.68	11.34	27.01	13.51	22.68	11.34
273	0.027	24.24	11.62	24.78	12.39	28.58	14.49	24.78	12.39
303	0.030	26.08	12.40	26.82	13.41	30.11	15.50	26.82	13.41
333	0.033	27.87	13.16	28.80	14.40	31.60	16.50	28.80	14.40
363	0.036	29.61	13.91	30.72	15.36	33.06	17.50	30.72	15.36
393	0.039	31.30	14.64	32.58	16.29	34.49	18.49	32.58	16.29
433	0.043	33.14	15.44	34.39	17.19	35.89	19.46	34.39	17.19
473	0.047	34.93	16.21	36.14	18.06	37.26	20.41	36.14	18.06
513	0.051	36.67	16.96	37.84	18.90	38.59	21.34	37.84	18.90
563	0.056	38.46	17.69	39.49	19.71	40.00	22.25	39.49	19.71
623	0.062	40.30	18.40	41.09	20.49	41.49	23.14	41.09	20.49
683	0.068	42.19	19.09	42.64	21.25	42.96	24.01	42.64	21.25
753	0.075	44.14	19.76	44.14	22.00	44.41	24.86	44.14	22.00
823	0.082	46.14	20.41	45.59	22.73	45.84	25.69	45.59	22.73
913	0.091	48.19	21.04	47.00	23.44	47.26	26.50	47.00	23.44
104	0.10	33.08	16.54	38.59	19.29	35.02	17.51	46.70	23.35
114	0.11	35.08	17.25	40.16	20.00	36.44	18.31	48.20	24.16
124	0.12	37.14	17.93	41.69	20.69	37.84	19.09	49.69	24.96
134	0.13	39.26	18.60	43.18	21.36	39.22	19.86	51.16	25.73
154	0.15	41.44	19.25	44.63	22.00	40.59	20.61	52.61	26.50
164	0.16	43.67	19.89	46.04	22.62	41.94	21.34	54.06	27.27
184	0.18	45.96	20.51	47.41	23.22	43.27	22.06	55.49	28.04
204	0.20	48.30	21.11	48.74	23.79	44.59	22.77	56.90	28.81
224	0.22	50.69	21.69	50.03	24.34	45.89	23.46	58.29	29.58
244	0.24	53.14	22.25	51.28	24.87	47.17	24.14	59.66	30.35
27									



◆Type MMT (B)

容量記号	静電容量 (μF)	50/63Vdc		100Vdc		250Vdc		450Vdc		630Vdc	
		単発 Single (Ao-p)	連続 Continual (Ao-p)	単発 Single (Ao-p)	連続 Continual (Ao-p)	単発 Single (Ao-p)	連続 Continual (Ao-p)	単発 Single (Ao-p)	連続 Continual (Ao-p)	単発 Single (Ao-p)	連続 Continual (Ao-p)
102	0.0010					0.32	0.32	0.46	0.09	0.54	0.11
122	0.0012					0.39	0.39	0.51	0.10	0.60	0.12
152	0.0015					0.48	0.48	0.57	0.11	0.67	0.13
182	0.0018					0.58	0.58	0.57	0.11	0.82	0.16
222	0.0022					0.71	0.71	0.62	0.12	0.84	0.17
272	0.0027					0.87	0.87	0.68	0.14	1.04	0.21
332	0.0033					1.07	1.07	0.83	0.17	1.26	0.25
392	0.0039					1.26	1.26	0.98	0.20	1.50	0.30
472	0.0047					1.39	1.39	1.18	0.24	1.79	0.36
562	0.0056					1.81	1.81	1.40	0.28	2.14	0.43
682	0.0068					2.20	2.20	1.70	0.34	2.59	0.52
822	0.0082					2.65	2.65	2.06	0.41	3.13	0.63
103	0.010	0.36	0.14	0.69	0.37	3.23	3.23	1.78	0.36	3.82	0.76
123	0.012	0.43	0.17	0.93	0.45	3.80	3.80	2.14	0.43		
153	0.015	0.54	0.21	1.04	0.45	3.88	3.88	2.67	0.53		
183	0.018	0.65	0.25	1.24	0.54	4.66	4.66	3.23	0.63		
223	0.022	0.79	0.31	1.52	0.66	4.98	4.98	3.93	0.79		
273	0.027	0.97	0.38	1.84	0.82	6.11	6.11	4.82	0.96		
333	0.033	1.19	0.46	2.28	1.00	7.47	7.47	5.91	1.18		
393	0.039	1.40	0.55	2.69	0.92	8.83	8.83	6.08	1.21		
473	0.047	1.69	0.66	3.24	0.75	10.64	10.64	7.34	1.47		
563	0.056	2.02	0.78	3.96	0.89	12.68	12.68	8.85	1.77		
683	0.068	2.45	0.95	4.69	0.97	15.39	15.39	10.63	2.13		
823	0.082	2.95	1.15	5.66	1.17	18.56	18.56	12.82	2.56		
104	0.10	3.60	1.40	6.90	1.43	22.64	22.64	15.61	3.12		
124	0.12	4.32	1.68	8.26	1.72	27.16	27.16				
154	0.15	5.40	2.10	10.35	2.14	33.95	33.95				
184	0.18	6.48	2.52	12.42	2.57	24.77	24.77				
224	0.22	7.92	3.08	15.18	3.15	30.27	30.27				
274	0.27	9.72	3.78	18.63	3.86	37.16	37.16				
334	0.33	11.88	4.62	22.77	4.72	45.40	45.40				
394	0.39	14.04	5.46	26.91	5.58						
474	0.47	16.92	6.58	32.43	6.72						
564	0.56	20.16	7.84	38.64	8.01						
684	0.68	24.48	9.52	46.92	9.72						
824	0.82	29.52	11.48	56.58	11.72						
105	1.0	36.00	14.00	69.00	14.30						
125	1.2	24.00	9.60								
155	1.5	30.00	12.00								
185	1.8	36.00	14.40								
225	2.2	44.00	17.60								
275	2.7	54.00	21.60								
335	3.3	66.00	26.40								

●この許容電流値は単位時間当たりの電圧勾配 (dv/dt) により求めた値で、 $I(Ao-p) = C(\mu F) \times dv/dt (V/\mu s)$ で算出されます。

詳しくは仕様書をご確認ください。

■Permissible current values below is computed as $I=C \times dv/dt (Ao-p)$ for further details, refer to our respective Specifications.

◆Type MPX

容量記号	静電容量 (μF)	450Vdc		630Vdc	
		単発 Single (Ao-p)	連続 Continual (Ao-p)	単発 Single (Ao-p)	連続 Continual (Ao-p)
104	0.10	10.08	1.43	19.20	2.70
124	0.12	12.96	1.72	23.04	3.23
154	0.15	16.20	2.15	28.80	4.04
184	0.18	18.44	2.58	34.56	4.85
224	0.22	23.76	3.15	42.24	5.93
274	0.27	29.16	3.87	27.27	3.81
334	0.33			33.33	4.66
394	0.39			39.39	5.51
474	0.47			47.47	6.64
564	0.56			56.56	7.91
684	0.68			68.68	9.60
824	0.82			48.38	6.95
105	1.0			59.00	8.47
125	1.2			70.80	10.17
155	1.5			88.50	12.71
185	1.8			106.20	15.25
225	2.2			129.80	18.64

◆Type MPW450Vdc

容量記号	静電容量 (μF)	01Z9		0000	
		単発 Single (Ao-p)	連続 Continual (Ao-p)	単発 Single (Ao-p)	連続 Continual (Ao-p)
334	0.33	11.56	3.78		
474	0.47	16.44	4.72		
684	0.68	23.76	6.83	13.32	4.41
105	1.0	35.04	7.37	19.68	6.48
155	1.5			29.52	6.05
225	2.2			43.20	8.66
335	3.3			64.80	13.63
475	4.7			92.28	19.41

◆Type MPW(X) 450Vdc

容量記号	静電容量 (μF)	01Z9		0000	
		単発 Single (Ao-p)	連続 Continual (Ao-p)	単発 Single (Ao-p)	連続 Continual (Ao-p)
474	0.47	14.10	2.30	7.05	1.30
684	0.68	20.40	3.40	10.20	1.90
105	1.0	30.00	5.00	15.00	2.80
155	1.5	45.00	7.50	22.50	4.20
225	2.2	66.00	10.90	33.00	6.20
335	3.3	99.00	16.40	49.50	9.30
475	4.7	141.00	23.30	70.50	13.20

◆Type ANZ・APS・AHS・ANR・NSM

許容ピーク電流値(単発・連続)は200Ao-p

Permissible peak current (Single/Continual)=200Ao-p

ご使用に関しては上記の許容ピーク電流値以内とし、実効値電流(Arms)も各タイプ別に示した周波数に対する許容電流特性値以下でご使用ください。

Operating conditions should not exceed the above peak current should not go beyond the permissible current and effective current(Arms) should not exceed the permissible current against frequency per capacitor type.

特徴/Features

- 非常に小型化されております。特に高さ(H)寸法が小さいため、機器の小型化に最適です。
- 民生機器から産業機器まで幅広くご好評を得ております。
- リードピッチ寸法の許容差を小さく抑えております。
- 小型軽量化されていることにより、自動挿入用コンデンサとして最適です。

- ★Very small size, especially in H dimension, which is advantageous to save space of PC Board.
- ★Good reputations for use in general and industrial application.
- ★Small allowance in the lead pitch dimensions.
- ★Suitable for automatic insertion due to their small size and light weight.

規格/Specifications

使用温度範囲 Temp. range	-40~+85°C (+105°C)*1	誘電正接 Tangent of loss angle	0.008 以下 or less (at 1kHz)
定格電圧 Rated voltage	50V, 100V, 250V, 400Vdc	絶縁抵抗 Insulation resistance	30000MΩ 以上 or more
静電容量範囲 Capacitance	50V 0.00010~0.15μF (E-12)	高温負荷 High temp. endurance	85°C、WV×140% 1000h印加 ΔC/C ±3% 以内、tanδ 0.011 以下 or less、IR 4500MΩ 以上 or more
	100V 0.00010~0.12μF (E-12)		
	250V 0.0010 ~0.047μF (E-12)		
	400V 0.0010 ~0.018μF (E-12)		
静電容量許容差 Cap. tolerance	±5% (J), ±10% (K)	耐湿負荷 Damp heat	40°C、90~95%RH、WV 1000h印加 ΔC/C ±2% 以内、tanδ 0.012 以下 or less、IR 9000MΩ 以上 or more

※1 () 温度は電圧軽減による使用可能範囲です。

※1 () Marked temperature shows operatable range when voltage is derated.

寸法/Dimensions (mm)

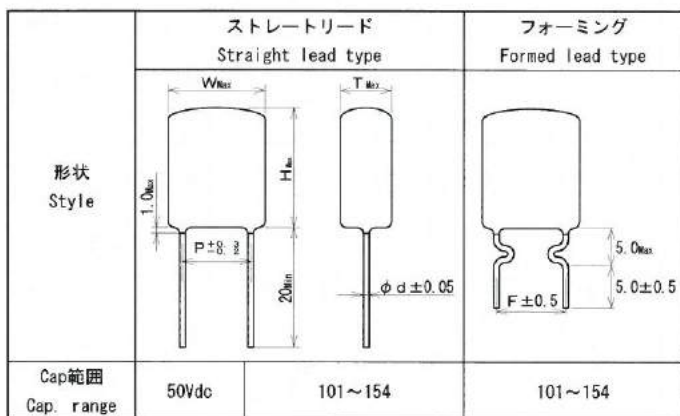

テーピング仕様のリードピッチ寸法(F)は、6~7頁のテーピング寸法表をご参照下さい。
For a pitch space (F) of the taping specification, refer to "TAPING DIMENSIONS" on pages 6 to 7.

Cap CODE	Cap (μF)	AMZ/AMZ(B) 50Vdc												
		AMZ/AMZ(B) 50Vdc							基準収納数 NUMBER OF PIECES FOR PACKING UNIT					
		W	H	T	P	F	φd	テーピング Taping	ロング Long		フォーミング Formed			
101	0.00010	5.7	7.5	3.7	3.5	5.0	0.5	2,000	200	3,000	200	5,000		
121	0.00012	5.7	7.5	3.7	3.5	5.0	0.5	2,000	200	3,000	200	5,000		
151	0.00015	5.7	7.5	3.7	3.5	5.0	0.5	2,000	200	3,000	200	5,000		
181	0.00018	5.7	7.5	3.5	3.5	5.0	0.5	2,000	200	3,000	200	5,000		
221	0.00022	5.5	7.3	3.2	3.5	5.0	0.5	2,000	200	3,000	200	5,000		
271	0.00027	5.2	7.0	2.8	3.5	5.0	0.5	2,000	200	3,000	200	5,000		
331	0.00033	5.2	7.0	2.8	3.5	5.0	0.5	2,000	200	3,000	200	5,000		
391	0.00039	5.2	7.0	2.8	3.5	5.0	0.5	2,000	200	3,000	200	5,000		
471	0.00047	5.2	7.0	2.8	3.5	5.0	0.5	2,000	200	3,000	200	5,000		
561	0.00056	4.8	7.0	2.8	3.5	5.0	0.5	3,000	200	3,000	200	5,000		
681	0.00068	5.0	7.0	2.8	3.5	5.0	0.5	2,000	200	3,000	200	5,000		
821	0.00082	4.8	7.0	2.5	3.5	5.0	0.5	3,000	200	3,000	200	5,000		
102	0.0010	4.8	7.0	2.5	3.5	5.0	0.5	3,000	200	3,000	200	5,000		
122	0.0012	4.8	7.0	2.5	3.5	5.0	0.5	3,000	200	3,000	200	5,000		
152	0.0015	4.8	7.0	2.5	3.5	5.0	0.5	3,000	200	3,000	200	5,000		
182	0.0018	4.8	7.0	2.5	3.5	5.0	0.5	3,000	200	3,000	200	5,000		
222	0.0022	4.8	7.0	2.8	3.5	5.0	0.5	3,000	200	3,000	200	5,000		
272	0.0027	4.8	7.0	2.8	3.5	5.0	0.5	3,000	200	3,000	200	5,000		
332	0.0033	4.8	7.0	2.8	3.5	5.0	0.5	3,000	200	3,000	200	5,000		
392	0.0039	5.0	7.0	2.8	3.5	5.0	0.5	3,000	200	3,000	200	5,000		
472	0.0047	5.0	7.0	2.8	3.5	5.0	0.5	3,000	200	3,000	200	5,000		
562	0.0056	4.8	7.0	2.8	3.5	5.0	0.5	3,000	200	3,000	200	5,000		
682	0.0068	4.8	7.0	2.8	3.5	5.0	0.5	3,000	200	3,000	200	5,000		
822	0.0082	5.0	7.0	2.8	3.5	5.0	0.5	2,000	200	3,000	200	5,000		
103	0.010	5.5	7.0	3.0	3.5	5.0	0.5	2,000	200	3,000	200	5,000		
123	0.012	5.8	7.0	3.3	3.5	5.0	0.5	2,000	200	3,000	200	5,000		
153	0.015	5.3	8.5	3.0	3.5	5.0	0.5	3,000	200	3,000	200	5,000		
183	0.018	5.3	8.5	3.0	3.5	5.0	0.5	3,000	200	3,000	200	5,000		
223	0.022	5.5	9.0	3.5	3.5	5.0	0.5	2,000	200	3,000	200	4,000		
273	0.027	5.5	9.0	3.0	3.5	5.0	0.5	2,000	200	3,000	200	4,000		
333	0.033	5.8	9.0	3.5	3.5	5.0	0.5	2,000	200	3,000	200	4,000		
393	0.039	5.5	9.0	3.5	3.5	5.0	0.5	2,000	200	3,000	200	3,000		
473	0.047	7.0	9.0	3.5	3.5	5.0	0.5	2,000	200	2,000	200	3,000		
563	0.056	7.0	9.5	4.0	3.0	5.0	0.5	2,000	200	2,000	200	3,000		
683	0.068	7.5	9.5	4.5	3.0	5.0	0.5	1,000	200	2,000	200	3,000		
823	0.082	8.0	9.5	4.5	3.0	5.0	0.5	1,000	200	2,000	200	3,000		
104	0.10	8.3	9.5	5.0	3.0	5.0	0.5	1,000	200	2,000	200	3,000		
124	0.12	7.8	11.0	5.0	3.0	5.0	0.5	1,000	200	2,000	200	2,000		
154	0.15	8.5	11.5	5.5	3.0	5.0	0.5	1,000	200	1,000	200	2,000		

ご使用にあたっては、使用上の注意事項(9-16頁)をご確認の上、技術仕様書等をお求め願ひ、仕様書の範囲内でのご使用をお願いします。 When using our capacitors, please consider the application notes on pages 9-16 and contact NISSEI for any additional technical specifications relating to the limits of our performance characteristics.

寸法/Dimensions (mm)

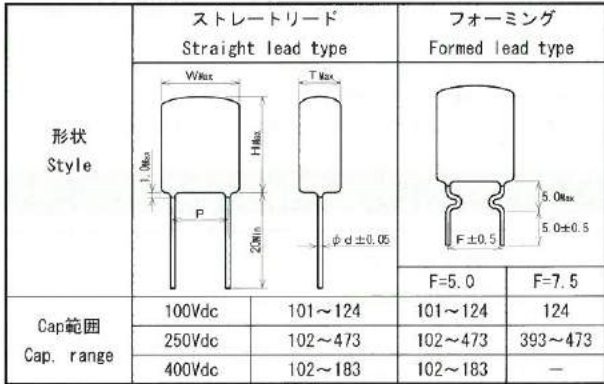

テーピング仕様のリードピッチ寸法(F)は、6~7頁のテーピング寸法表をご参照下さい。
For a pitch space (F) of the taping specification, refer to "TAPING DIMENSIONS" on pages 6 to 7.

Cap CODE	Cap (μF)	AMZ(B) 100Vdc						基準収納数 NUMBER OF PIECES FOR PACKING UNIT									
		W	H	T	P	F	φ d	テーピング Taping	ロング Long	フォーミング Formed	Ammo	Bag	Box	Bag	Box		
101	0.00010	5.7	7.5	3.7	3.5±0.5	5.0	0.5	2,000	200	3,000	200	5,000	200	200	3,000	200	5,000
121	0.00012	5.7	7.5	3.7	3.5±0.5	5.0	0.5	2,000	200	3,000	200	5,000	200	200	3,000	200	5,000
151	0.00015	5.7	7.5	3.7	3.5±0.5	5.0	0.5	2,000	200	3,000	200	5,000	200	200	3,000	200	5,000
181	0.00018	5.7	7.5	3.5	3.5±0.5	5.0	0.5	2,000	200	3,000	200	5,000	200	200	3,000	200	5,000
221	0.00022	5.5	7.3	3.2	3.5±0.5	5.0	0.5	2,000	200	3,000	200	5,000	200	200	3,000	200	5,000
271	0.00027	5.2	7.0	2.8	3.5±0.5	5.0	0.5	2,000	200	3,000	200	5,000	200	200	3,000	200	5,000
331	0.00033	5.2	7.0	2.8	3.5±0.5	5.0	0.5	2,000	200	3,000	200	5,000	200	200	3,000	200	5,000
391	0.00039	5.2	7.0	2.8	3.5±0.5	5.0	0.5	2,000	200	3,000	200	5,000	200	200	3,000	200	5,000
471	0.00047	5.2	7.0	2.8	3.5±0.5	5.0	0.5	2,000	200	3,000	200	5,000	200	200	3,000	200	5,000
561	0.00056	4.8	7.0	2.8	3.5±0.5	5.0	0.5	3,000	200	3,000	200	5,000	200	200	3,000	200	5,000
681	0.00068	5.0	7.0	2.8	3.5±0.5	5.0	0.5	2,000	200	3,000	200	5,000	200	200	3,000	200	5,000
821	0.00082	4.8	7.0	2.5	3.5±0.5	5.0	0.5	3,000	200	3,000	200	5,000	200	200	3,000	200	5,000
102	0.0010	4.8	7.0	2.5	3.5±0.5	5.0	0.5	3,000	200	3,000	200	5,000	200	200	3,000	200	5,000
122	0.0012	4.8	7.0	2.5	3.5±0.5	5.0	0.5	3,000	200	3,000	200	5,000	200	200	3,000	200	5,000
152	0.0015	4.8	7.0	2.5	3.5±0.5	5.0	0.5	3,000	200	3,000	200	5,000	200	200	3,000	200	5,000
182	0.0018	4.8	7.0	2.5	3.5±0.5	5.0	0.5	3,000	200	3,000	200	5,000	200	200	3,000	200	5,000
222	0.0022	4.8	7.0	2.8	3.5±0.5	5.0	0.5	3,000	200	3,000	200	5,000	200	200	3,000	200	5,000
272	0.0027	4.8	7.0	2.8	3.5±0.5	5.0	0.5	3,000	200	3,000	200	5,000	200	200	3,000	200	5,000
332	0.0033	4.8	7.0	2.8	3.5±0.5	5.0	0.5	3,000	200	3,000	200	5,000	200	200	3,000	200	5,000
392	0.0039	5.0	7.0	2.5	3.5±0.5	5.0	0.5	3,000	200	3,000	200	5,000	200	200	3,000	200	5,000
472	0.0047	5.0	7.0	2.5	3.5±0.5	5.0	0.5	3,000	200	3,000	200	5,000	200	200	3,000	200	5,000
562	0.0056	4.8	7.0	2.8	3.5±0.5	5.0	0.5	3,000	200	3,000	200	5,000	200	200	3,000	200	5,000
682	0.0068	4.8	7.0	2.8	3.5±0.5	5.0	0.5	3,000	200	3,000	200	5,000	200	200	3,000	200	5,000
822	0.0082	5.0	7.0	2.8	3.5±0.5	5.0	0.5	2,000	200	3,000	200	5,000	200	200	3,000	200	5,000
103	0.010	5.5	7.0	3.0	3.5±0.5	5.0	0.5	2,000	200	3,000	200	5,000	200	200	3,000	200	5,000
123	0.012	5.8	7.0	3.3	3.5±0.5	5.0	0.5	2,000	200	3,000	200	5,000	200	200	3,000	200	5,000
153	0.015	6.0	9.5	4.0	3.5±0.5	5.0	0.5	2,000	200	3,000	200	5,000	200	200	3,000	200	5,000
183	0.018	6.5	9.5	4.5	3.5±0.5	5.0	0.5	2,000	200	3,000	200	5,000	200	200	3,000	200	5,000
223	0.022	6.5	9.5	4.5	3.5±0.5	5.0	0.5	2,000	200	3,000	200	5,000	200	200	3,000	200	5,000
273	0.027	6.5	11.5	3.5	3.5±0.5	5.0	0.5	2,000	200	2,000	200	4,000	200	200	3,000	200	5,000
333	0.033	7.0	11.5	4.0	3.5±0.5	5.0	0.5	2,000	200	2,000	200	3,000	200	200	3,000	200	5,000
393	0.039	8.0	12.0	4.0	5.0±0.5	5.0	0.5	2,000	200	2,000	200	3,000	200	200	3,000	200	5,000
473	0.047	8.0	12.0	4.0	5.0±0.5	5.0	0.5	2,000	200	2,000	200	3,000	200	200	3,000	200	5,000
563	0.056	7.5	12.5	5.0	5.0±0.5	5.0	0.5	1,000	200	2,000	200	3,000	200	200	3,000	200	5,000
683	0.068	7.5	12.5	5.0	5.0±0.5	5.0	0.5	1,000	200	2,000	200	3,000	200	200	3,000	200	5,000
823	0.082	8.5	12.5	5.8	5.0±0.5	5.0	0.5	1,000	200	2,000	200	3,000	200	200	3,000	200	5,000
104	0.10	8.5	12.5	5.8	5.0±0.5	5.0	0.5	1,000	200	1,000	200	2,000	200	200	3,000	200	5,000
124	0.12	11.0	12.5	6.0	7.5±0.5	5.0/7.5	0.5	1,000	200	1,000	100	1,000	200	200	3,000	200	5,000

Cap CODE	Cap (μF)	AMZ 250Vdc						AMZ 400Vdc															
		W	H	T	P	F	φ d	テーピング Taping	ロング Long	フォーミング Formed	Ammo	Bag	Box	Bag	Box								
102	0.0010	5.3	10.0	2.8	3.5±0.5	5.0	0.5	2,000	200	3,000	200	5,000	6.5	11.0	3.5	4.0±0.5	5.0	0.5	2,000	200	2,000	200	5,000
122	0.0012	5.3	11.0	2.8	3.5±0.5	5.0	0.5	2,000	200	3,000	200	5,000	6.5	11.0	3.5	4.0±0.5	5.0	0.5	2,000	200	2,000	200	5,000
152	0.0015	5.3	11.0	2.8	3.5±0.5	5.0	0.5	2,000	200	3,000	200	5,000	6.5	11.0	3.5	4.0±0.5	5.0	0.5	2,000	200	2,000	200	4,000
182	0.0018	5.3	11.0	2.8	3.5±0.5	5.0	0.5	2,000	200	3,000	200	5,000	7.0	11.0	4.0	4.0±0.5	5.0	0.5	2,000	200	2,000	200	4,000
222	0.0022	5.3	11.0	2.5	3.5±0.5	5.0	0.5	2,000	200	3,000	200	5,000	7.0	11.5	4.0	4.0±0.5	5.0	0.5	2,000	200	2,000	200	4,000
272	0.0027	5.3	11.0	2.5	3.5±0.5	5.0	0.5	2,000	200	3,000	200	5,000	7.5	11.5	4.0	5.0±0.5	5.0	0.5	2,000	200	2,000	200	3,000
332	0.0033	5.3	11.0	2.5	3.5±0.5	5.0	0.5	2,000	200	3,000	200	5,000	7.5	11.5	4.0	5.0±0.5	5.0	0.5	1,000	200	2,000	200	3,000
392	0.0039	5.5	11.0	2.8	3.5±0.5	5.0	0.5	2,000	200	3,000	200	5,000	8.5	13.0	4.5	6.0±0.5	5.0	0.5	1,000	200	2,000	200	3,000
472	0.0047	5.8	11.0	2.8	3.5±0.5	5.0	0.5	2,000	200	3,000	200	5,000	8.5	13.0	4.5	6.0±0.5	5.0	0.5	1,000	200	2,000	200	2,000
562	0.0056	6.8	11.0	3.0	5.0±0.5	5.0	0.5	2,000	200	3,000	200	4,000	8.5	13.0	4.5	6.0±0.5	5.0	0.5	1,000	200	2,000	200	2,000
682	0.0068	7.0	11.0	3.3	5.0±0.5	5.0	0.5	2,000	200	2,000	200	4,000	9.0	13.0	4.5	6.0±0.5	5.0	0.5	1,000	200	1,000	100	2,000
822	0.0082	7.3	12.0	3.3	5.0±0.5	5.0	0.5	2,000	200	2,000	200	4,000	9.5	13.5	5.5	6.0±0.5	5.0	0.5	1,000	200	1,000	100	2,000
103	0.010	7.3	12.0	3.3	5.0±0.5	5.0	0.5	2,000	200	2,000	200	4,000	9.5	13.5	5.5	6.5±0.5	5.0	0.5	1,000	200	1,000	100	1,000
123	0.012	7.3	12.0	3.5	5.5±0.5	5.0	0.5	2,000	200	2,000	200	3,000	10.0	14.0	6.0	7.0±0.5	5.0/7.5	0.5	1,000	100	1,000	100	1,000
153	0.015	7.5	12.0	3.5	5.5±0.5	5.0	0.5	1,000	200	2,000	200	3,000	11.0	14.0	6.5	7.5±0.5	5.0/7.5	0.5	500	100	1,000	100	1,000
183	0.018	7.8	12.0	3.8	6.0±0.5	5.0	0.5	1,000	200	2,000	200	3,000	11.5	16.0	6.5	7.0±0.5	5.0/7.5	0.6	500	100	500	50	1,000
223	0.022	8.3	12.0	4.0	6.0±0.5	5.0	0.5	1,000	200	2,000	200	3,000											
273	0.027	9.0	12.0	4.5	6.0±0.5	5.0	0.5	1,000	200	1,000	100	2,000											
333	0.033	9.0	12.5	4.5	6.5±0.5	5.0	0.5	1,000	200	1,000	100	2,000											
393	0.039	9.8	12.5	5.3	6.5±0.5	5.0/7.5	0.5	1,000	200	1,000	100	2,000											
473	0.047	11.5	15.5	6.5	7.5±0.5	5.0/7.5	0.6	500	100	500	100	1,000											

ご使用にあたっては、使用上の注意事項(9-16頁)をご確認の上、技術仕様書等をお求め願ひ、仕様書の範囲内でのご使用をお願いします。 When using our capacitors, please consider the application notes on pages 9-16 and contact NISSEI for any additional technical specifications relating to the limits of our performance characteristics.

周波数に対する許容電流特性 / Characteristics of permissible current to frequency

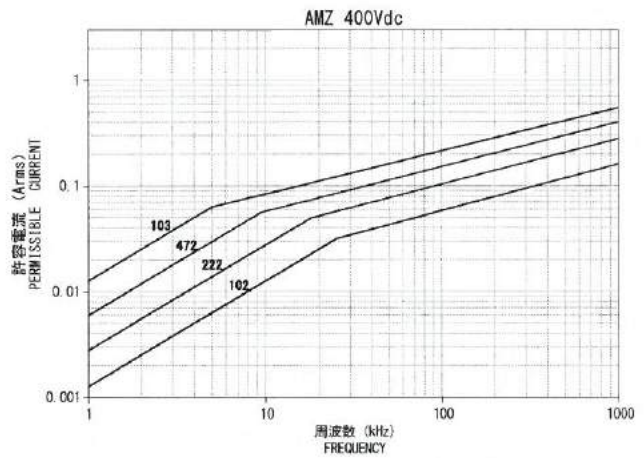
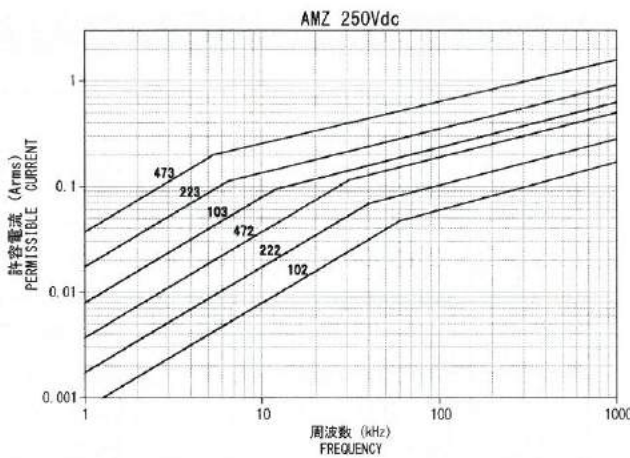
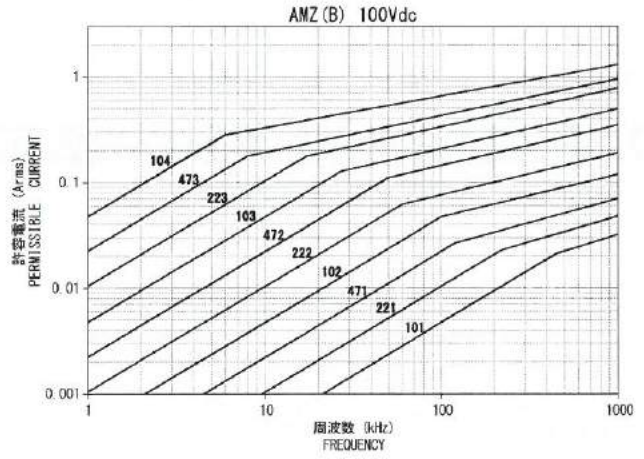
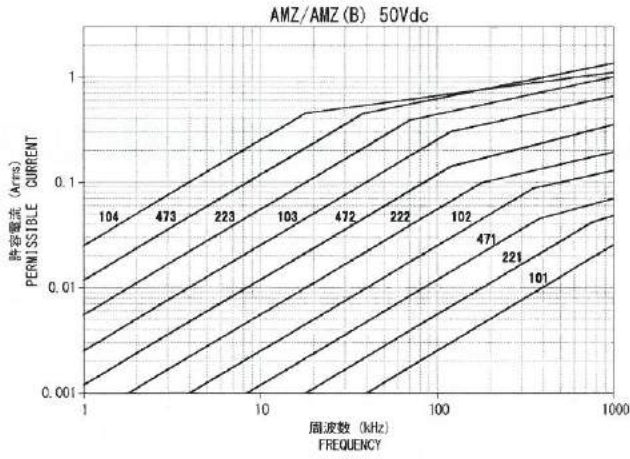

ご使用にあたっては、使用上の注意事項(9-16頁)をご確認の上、技術仕様書等をお求め願ひ、仕様書の範囲内でのご使用をお願いします。

When using our capacitors, please consider the application notes on pages 9-16 and contact NISSEI for any additional technical specifications relating to the limits of our performance characteristics.

特徴/Features

- スナバ回路、小ワット共振回路に最適です。
 - 外装樹脂はエポキシ樹脂でディップされ、耐湿性、耐溶剤性に優れています。
 - 容量の温度特性は負の特性を示します。
 - 誘電正接が極めて小さく、容量の経時変化も小さい製品です。
- ★ Suitable for snubber circuits, small watts resonant circuits.
 - ★ Protected against moisture and solvent through our original epoxy resin vacuum impregnation.
 - ★ Temperature characteristic of capacitance is negative.
 - ★ Tangent of loss angle is very low, with an excellent long stability.

規格/Specifications

使用温度範囲 Temp. range	-40~+85°C	絶縁抵抗 Insulation resistance	30000MΩ 以上 or more
定格電圧 Rated voltage	100V, 250V, 400Vdc	高温負荷 Endurance	85°C、WV×140% 1000h印加 ΔC/C ±3%許容 in tanδ C ≤ 0.10μF 0.0011 ₁₀₀ T _{ESS} C > 0.10μF 0.0013 ₁₀₀ T _{ESS}
静電容量範囲 Capacitance	100V 0.00010~0.22μF, 250V 0.00010~0.010μF 400V 0.0010~0.010μF	耐湿負荷 Damp heat	40°C、90~95%RH、WV 1000h印加 ΔC/C ±3%許容 in tanδ C ≤ 0.10μF 0.0012 ₁₀₀ T _{ESS} C > 0.10μF 0.0014 ₁₀₀ T _{ESS}
静電容量許容差 Cap. tolerance	100V ±1%(F), ±2%(G), ±5%(J), ±10%(K) 250V, 400V ±5%(J), ±10%(K)		
誘電正接 Tangent of loss angle	C ≤ 0.10μF 0.0010 ₁₀₀ T _{ESS} C > 0.10μF 0.0012 ₁₀₀ T _{ESS} (at 1kHz)		

形状 Style	ストレートリード Straight lead type		フォーミング Formed lead type		
Cap.範囲 Cap. range	100Vdc 101~224 250Vdc 101~103 400Vdc 102~103	123~124 — 102~103	134~224 — —	101~113 — —	— — —

テーピング仕様のリードピッチ寸法(F)は、6~7頁のテーピング寸法表をご参照下さい。
For a pitch space (F) of the taping specification, refer to "TAPING DIMENSIONS" on pages 6 to 7.

周波数に対する許容電流特性

Characteristics of permissible current to frequency

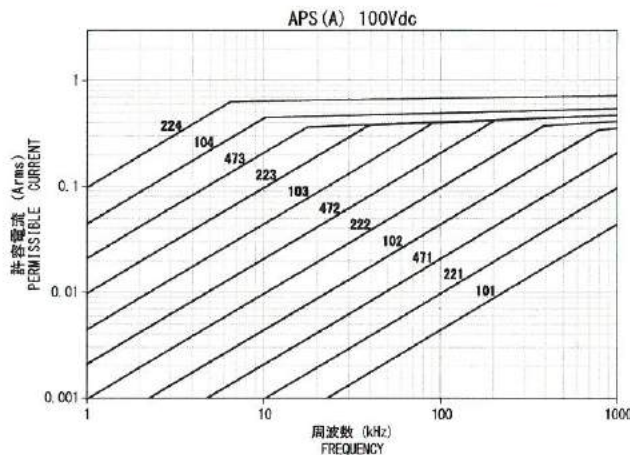

寸法/Dimensions (mm)

Cap CODE	Cap (μF)	APS(A) 100Vdc						基本包装数 NUMBER OF PIECES FOR PACKING UNIT				
		W	H	T	P	F	φd	テーピング Taping	ロング Long	フォーミング Formed		
101	0.00010	6.0	9.0	4.0	3.5	5.0	0.5	2,000	200	3,000	200	5,000
121	0.00012	6.6	9.0	4.0	3.5	5.0	0.5	2,000	200	3,000	200	5,000
151	0.00015	6.0	9.0	4.0	3.5	5.0	0.5	2,000	200	3,000	200	5,000
181	0.00018	6.0	9.0	4.0	3.5	5.0	0.5	2,000	200	3,000	200	5,000
221	0.00022	6.0	8.5	3.5	3.5	5.0	0.5	2,000	200	3,000	200	5,000
271	0.00027	6.0	8.5	3.5	3.5	5.0	0.5	2,000	200	3,000	200	5,000
331	0.00033	6.0	8.5	3.5	3.5	5.0	0.5	2,000	200	3,000	200	5,000
391	0.00039	6.0	8.5	3.5	3.5	5.0	0.5	2,000	200	3,000	200	5,000
471	0.00047	6.0	8.5	3.5	3.5	5.0	0.5	2,000	200	3,000	200	5,000
561	0.00056	6.0	8.5	3.5	3.5	5.0	0.5	2,000	200	3,000	200	5,000
681	0.00068	6.0	8.5	3.5	3.5	5.0	0.5	2,000	200	3,000	200	5,000
821	0.00082	6.0	8.5	3.5	3.5	5.0	0.5	2,000	200	3,000	200	5,000
102	0.0010	6.0	8.5	3.5	3.5	5.0	0.5	2,000	200	3,000	200	5,000
122	0.0012	6.0	8.5	3.5	3.5	5.0	0.5	2,000	200	3,000	200	5,000
152	0.0015	6.0	8.5	3.5	3.5	5.0	0.5	2,000	200	3,000	200	5,000
182	0.0018	6.0	8.5	3.5	3.5	5.0	0.5	2,000	200	3,000	200	5,000
222	0.0022	6.0	8.5	3.5	3.5	5.0	0.5	2,000	200	3,000	200	5,000
272	0.0027	6.0	8.5	3.5	3.5	5.0	0.5	2,000	200	3,000	200	5,000
332	0.0033	6.0	8.5	3.5	3.5	5.0	0.5	2,000	200	3,000	200	5,000
392	0.0039	6.0	8.5	3.5	3.5	5.0	0.5	2,000	200	3,000	200	5,000
472	0.0047	6.0	8.5	3.5	3.5	5.0	0.5	2,000	200	3,000	200	5,000
562	0.0056	6.0	8.5	3.5	3.5	5.0	0.5	2,000	200	3,000	200	5,000
682	0.0068	6.0	8.5	3.5	3.5	5.0	0.5	2,000	200	3,000	200	5,000
822	0.0082	7.0	9.5	4.0	3.5	5.0	0.5	1,000	200	2,000	200	4,000
103	0.010	7.0	9.5	4.0	3.5	5.0	0.5	1,000	200	2,000	200	3,000
123	0.012	7.5	10.5	4.0	3.5	5.0	0.5	1,000	200	2,000	200	3,000
153	0.015	7.5	10.5	4.5	5.0	5.0	0.5	1,000	200	2,000	200	3,000
183	0.018	8.0	11.0	5.0	5.0	5.0	0.5	1,000	200	2,000	200	3,000
223	0.022	8.0	11.0	5.0	5.0	5.0	0.5	1,000	200	2,000	200	3,000
273	0.027	9.0	12.0	5.5	5.0	5.0	0.5	1,000	200	2,000	200	3,000
333	0.033	9.0	12.0	5.5	5.0	5.0	0.5	1,000	200	2,000	200	3,000
393	0.039	10.0	13.0	6.0	7.5	5.0/7.5	0.5	1,000	200	1,000	200	2,000
473	0.047	10.0	13.0	6.0	7.5	5.0/7.5	0.5	1,000	200	1,000	200	1,000
563	0.056	11.0	14.0	6.0	7.5	5.0/7.5	0.5	1,000	200	1,000	100	1,000
683	0.068	11.0	14.0	6.5	7.5	5.0/7.5	0.5	500	200	1,000	100	1,000
822	0.082	11.5	14.0	7.0	7.5	5.0/7.5	0.5	500	200	1,000	100	1,000
104	0.10	12.0	14.0	7.5	7.5	5.0/7.5	0.5	500	100	500	100	1,000
124	0.12	13.0	14.0	8.0	7.5	5.0/7.5	0.5	500	100	500	100	500
154	0.15	14.0	19.5	7.5	10.0	5.0/7.5	0.6		100	500	50	500
184	0.18	15.0	19.5	7.5	10.0	5.0/7.5	0.6		100	500	50	500
224	0.22	15.0	19.5	8.0	10.0	5.0/7.5	0.6		100	500	50	500

ご使用にあたっては、使用上の注意事項(9-16頁)をご確認の上、技術仕様書等をお求め願ひ、仕様書の範囲内でのご使用をお願いします。 When using our capacitors, please consider the application notes on pages 9-16 and contact NISSEI for any additional technical specifications relating to the limits of our performance characteristics.

特徴/Features

- 誘電体にポリフェニレンスルフィドフィルムを使用した最高使用温度+125°C保証のフィルムコンデンサです。
- エンジンルーム等、高温下で連続使用が可能です。
- 容量の温度特性が極めて優れ、100°Cまでフラットです。

- ★Film capacitor using polyphenylene sulfide film as dielectric, applicable for a +125°C maximum operating temperature.
- ★Capable of continuous operation under a high temperature environment such as engine-room of automobile.
- ★Excellent temperature characteristics with flat capacitance change up to 100°C.

規格/Specifications

使用温度範囲 Temp. range	-55~+125°C	絶縁抵抗 Insulation resistance	C ≤ 0.33 μF 50,000Ω _{100Vdc} C > 0.33 μF 30,000Ω _{100Vdc}
定格電圧 Rated voltage	50V, 100Vdc	高温負荷 Endurance	125°C, WV × 140% 1000h印加 ΔC/C ±5% _{100Vdc} in tan δ C ≤ 0.33 μF 0.004 _{100Vdc} C > 0.33 μF 0.006 _{100Vdc}
静電容量範囲 Capacitance	50V 0.00027~0.47 μF 100V 0.00018~0.010 μF		耐湿負荷 Damp heat
静電容量許容差 Cap. tolerance	±2% (G), ±5% (J)	誘電正接 Tangent of loss angle	

周波数に対する許容電流特性/Characteristics of permissible current to frequency

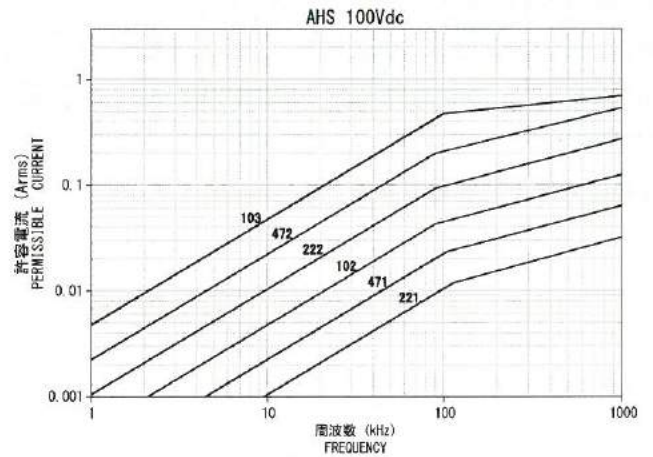
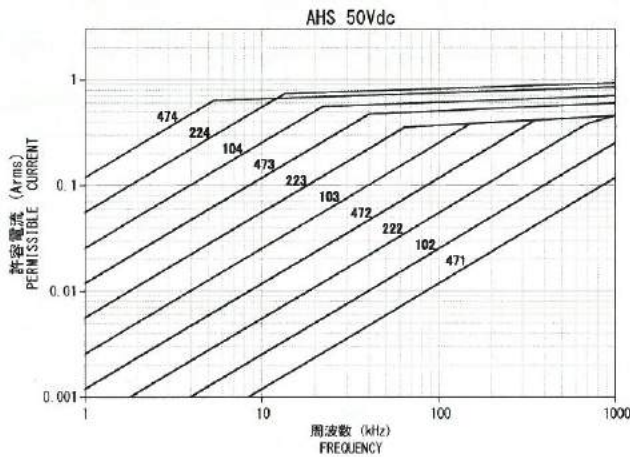

ご使用にあたっては、使用上の注意事項(9-16頁)をご確認の上、技術仕様書等をお求め願ひ、仕様書の範囲内でのご使用をお願いし

When using our capacitors, please consider the application notes on pages 9-16 and contact NISSEI for any additional technical specifications relating to the limits of our performance characteristics.

特徴/Features

- 誘電体にポリエステルフィルムを使用した信頼性の高い製品です。 ★Polyester film as dielectric provides high reliability and safety.
- 小型軽量のためP形ケース入りグロースターター用コンデンサとして最適です。 ★Smallness and light weight are suitable for glowstarter capacitors.

規格/Specifications

使用温度範囲 Temp. range	-40~+85°C		
定格電圧 Rated voltage	220V, 250Vac		
静電容量範囲 Capacitance	0.001~0.01 μ F (E-12), 0.006 μ F※		
静電容量許容差 Cap. tolerance	接地用 Ground capacitor	: $\pm 10\%$ (K)	雑音防止用 Noise suppression
			220Vac -16.6%~+20%
			250Vac -0%~+20%
誘電正接 Tangent of loss angle	0.01 $\tan \delta_{\text{ess}}$		
耐電圧 Voltage proof	1,600Vac 1~5sec.		
絶縁抵抗 Insulation resistance	20,000M Ω $\tan \delta_{\text{ins}}$		

※ 雑音防止用は、0.006 μ Fのみとなります。
 ※ For noise suppression : Only 0.006 μ F

寸法/Dimensions (mm)

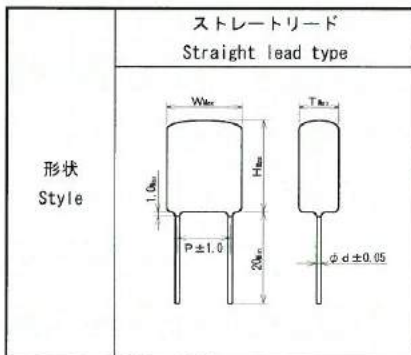

Cap CODE	Cap (μ F)	NSM(A) 220Vac							NSM(A) 250Vac						
		W	H	T	P	ϕd	標準収納数 NUMBER OF PIECES ロング Long		W	H	T	P	ϕd	標準収納数 NUMBER OF PIECES ロング Long	
102	0.0010	8.8	10.5	3.8	6.3	0.5	200	1,000	8.8	10.5	3.8	6.3	0.5	200	1,000
122	0.0012	9.0	10.5	4.0	6.3	0.5	200	1,000	9.0	10.5	4.0	6.3	0.5	200	1,000
152	0.0015	9.3	10.5	4.2	6.3	0.5	200	1,000	9.3	10.5	4.2	6.3	0.5	200	1,000
182	0.0018	9.5	10.5	4.5	6.3	0.5	200	1,000	9.5	10.5	4.5	6.3	0.5	200	1,000
222	0.0022	9.0	12.5	4.2	6.2	0.5	200	1,000	9.0	12.5	4.2	6.2	0.5	200	1,000
272	0.0027	9.2	12.5	4.4	6.2	0.5	200	1,000	9.2	12.5	4.4	6.2	0.5	200	1,000
332	0.0033	9.4	12.5	4.8	6.2	0.5	200	1,000	9.4	12.5	4.8	6.2	0.5	200	1,000
392	0.0039	9.8	12.5	5.0	6.2	0.5	200	1,000	9.8	12.5	5.0	6.2	0.5	200	1,000
472	0.0047	10.2	13.0	5.3	6.2	0.5	200	1,000	10.2	13.0	5.3	6.2	0.5	200	1,000
562	0.0056	9.8	15.5	5.0	6.2	0.5	200	1,000	9.8	15.5	5.0	6.2	0.5	200	1,000
602	0.0060	10.5	16.0	4.5	6.5	0.5	200	1,000	10.3	16.0	5.5	6.0	0.5	200	1,000
682	0.0068	10.5	16.0	5.2	6.3	0.5	100	1,000	10.5	16.0	5.2	6.3	0.5	100	1,000
822	0.0082	10.5	16.0	5.5	6.3	0.5	100	1,000	10.5	16.0	5.5	6.3	0.5	100	1,000
103	0.010	10.5	16.0	6.0	6.3	0.5	100	1,000	10.5	15.0	6.0	6.3	0.5	100	1,000

ご使用にあたっては、使用上の注意事項(9-16頁)をご確認の上、技術仕様書等をお求め願ひ、仕様書の範囲内でのご使用をお願いします。 When using our capacitors, please consider the application notes on pages 9-16 and contact NISSEI for any additional technical specifications relating to the limits of our performance characteristics.

特徴/Features

- MMCタイプを更に、小型化した製品です。
- 自己回復作用があるため、信頼性に優れております。
- 外装は最新のエポキシ加工により難燃性のエポキシ樹脂による均一な厚さで覆われていますので小型軽量となっています。

- ★Smaller version of MMC type.
- ★Highly reliable because of its self-healing performance.
- ★Uniform flame-retardant epoxy resin coating through the latest resin technology. This provides miniature size and light weight.

規格/Specifications

使用温度範囲 Temp. range	-40~+85°C (+105°C)※1	絶縁抵抗 Insulation resistance	$C \leq 0.33 \mu F$ 15,000M Ω $\frac{1}{F}$ $\frac{1}{V}$ $\frac{1}{s}$ $C > 0.33 \mu F$ 5,000 Ω $\frac{1}{F}$ $\frac{1}{V}$ $\frac{1}{s}$
定格電圧 Rated voltage	250V, 400V, 450V※2, 630Vdc	高温負荷 Endurance	85°C, WV×125% 1000hr印加 ※3 $\Delta C/C \pm 10\%$ $\frac{1}{\%}$ $\frac{1}{in}$ $\tan \delta 0.011$ $\frac{1}{\%}$ $\frac{1}{at}$ T_{ess} $IR C \leq 0.33 \mu F$ 2,700M Ω $\frac{1}{F}$ $\frac{1}{V}$ $\frac{1}{s}$ $C > 0.33 \mu F$ 900 Ω $\frac{1}{F}$ $\frac{1}{V}$ $\frac{1}{s}$
静電容量範囲 Capacitance	250Vdc 0.0010~10 μF (E-12), 450Vdc 0.10~2.2 μF (E-12) 400Vdc 0.0010~4.7 μF (E-12), 630Vdc 0.0010~2.2 μF (E-12)	耐湿負荷 Damp heat	40°C, 90~95%RH, WV 500hr印加 $\Delta C/C \pm 10\%$ $\frac{1}{\%}$ $\frac{1}{in}$ $\tan \delta 0.011$ $\frac{1}{\%}$ $\frac{1}{at}$ T_{ess} $IR C \leq 0.33 \mu F$ 2,700M Ω $\frac{1}{F}$ $\frac{1}{V}$ $\frac{1}{s}$ $C > 0.33 \mu F$ 900 Ω $\frac{1}{F}$ $\frac{1}{V}$ $\frac{1}{s}$
静電容量許容差 Cap. tolerance	±5% (J), ±10% (K)		
誘電正接 Tangent of loss angle	0.008 $\frac{1}{\%}$ $\frac{1}{at}$ T_{ess} (at 1kHz)		

※1 () 温度は電圧軽減による使用可能範囲です。

※2 450Vdcはアクティブフィルタ専用

※3 450Vdcは85°C WV×111% 1000hr印加

※1 () Marked temperature shows operatable when voltage is derated.

※2 450Vdc:Recommended for Active filtering circuit.

※3 450Vdc:85°C WV×111% 1000hr applied.

寸法/Dimensions (mm)

Cap CODE	Cap (μF)	MMX 250Vdc																MMX 400Vdc															
		基準収納数 NUMBER OF PIECES FOR PACKING UNIT																基準収納数 NUMBER OF PIECES FOR PACKING UNIT															
		W	H	T	P	F	φd	テープング Taping	ロング Long	フォーミング Formed	テープング Taping	ロング Long	フォーミング Formed	W	H	T	P	F	φd	テープング Taping	ロング Long	フォーミング Formed	テープング Taping	ロング Long	フォーミング Formed								
102	0.0010	7.3	6.5	3.7	5.0	5.0	0.6	2,000	200	2,000	200	2,000	9.8	5.5	3.5	7.5	5.0/7.5	0.6	2,000	200	2,000	200	2,000										
122	0.0012	7.3	6.5	3.7	5.0	5.0	0.6	2,000	200	2,000	200	2,000	9.8	5.5	3.5	7.5	5.0/7.5	0.6	2,000	200	2,000	200	2,000										
152	0.0015	7.3	6.5	3.7	5.0	5.0	0.6	2,000	200	2,000	200	2,000	9.8	5.5	3.5	7.5	5.0/7.5	0.6	2,000	200	2,000	200	2,000										
182	0.0018	7.3	6.5	3.7	5.0	5.0	0.6	2,000	200	2,000	200	2,000	9.8	5.5	3.5	7.5	5.0/7.5	0.6	2,000	200	2,000	200	2,000										
222	0.0022	7.3	6.5	3.7	5.0	5.0	0.6	2,000	200	2,000	200	2,000	9.8	5.5	3.5	7.5	5.0/7.5	0.6	2,000	200	2,000	200	2,000										
272	0.0027	7.3	6.5	3.7	5.0	5.0	0.6	2,000	200	2,000	200	2,000	9.8	5.5	3.5	7.5	5.0/7.5	0.6	2,000	200	2,000	200	2,000										
332	0.0033	7.3	6.5	3.7	5.0	5.0	0.6	2,000	200	2,000	200	2,000	9.8	6.0	4.2	7.5	5.0/7.5	0.6	1,000	200	2,000	200	2,000										
392	0.0039	7.3	6.5	3.7	5.0	5.0	0.6	2,000	200	2,000	200	2,000	9.8	6.0	4.2	7.5	5.0/7.5	0.6	1,000	200	2,000	200	2,000										
472	0.0047	7.3	6.5	3.7	5.0	5.0	0.6	2,000	200	2,000	200	2,000	9.8	6.0	4.2	7.5	5.0/7.5	0.6	1,000	200	2,000	200	2,000										
582	0.0058	7.3	6.5	3.7	5.0	5.0	0.6	2,000	200	2,000	200	2,000	9.8	6.5	4.4	7.5	5.0/7.5	0.6	1,000	200	2,000	200	2,000										
682	0.0068	7.3	6.5	3.7	5.0	5.0	0.6	2,000	200	2,000	200	2,000	9.8	6.5	4.4	7.5	5.0/7.5	0.6	1,000	200	2,000	200	2,000										
822	0.0082	7.3	6.5	3.7	5.0	5.0	0.6	2,000	200	2,000	200	2,000	9.8	6.8	4.4	7.5	5.0/7.5	0.6	1,000	200	2,000	200	2,000										
103	0.010	7.3	6.5	3.7	5.0	5.0	0.6	2,000	200	2,000	200	2,000	9.8	6.8	3.5	7.5	5.0/7.5	0.6	2,000	200	2,000	200	2,000										
123	0.012	7.3	6.5	3.7	5.0	5.0	0.6	2,000	200	2,000	200	2,000	9.8	6.8	3.5	7.5	5.0/7.5	0.6	2,000	200	2,000	200	2,000										
153	0.015	7.3	6.5	3.7	5.0	5.0	0.6	2,000	200	2,000	200	2,000	9.8	6.8	4.0	7.5	5.0/7.5	0.6	1,000	200	2,000	200	2,000										
183	0.018	7.3	6.5	3.7	5.0	5.0	0.6	2,000	200	2,000	200	2,000	9.8	6.8	4.0	7.5	5.0/7.5	0.6	1,000	200	2,000	200	2,000										
223	0.022	7.3	6.5	3.7	5.0	5.0	0.6	2,000	200	2,000	200	2,000	9.8	6.8	4.0	7.5	5.0/7.5	0.6	1,000	200	2,000	200	2,000										
273	0.027	7.3	6.5	3.7	5.0	5.0	0.6	2,000	200	2,000	200	2,000	9.8	6.8	4.2	7.5	5.0/7.5	0.6	1,000	200	2,000	200	2,000										
333	0.033	7.3	6.5	3.7	5.0	5.0	0.6	2,000	200	2,000	200	2,000	9.8	6.8	4.2	7.5	5.0/7.5	0.6	1,000	200	2,000	200	2,000										
393	0.039	7.3	6.3	4.0	5.0	5.0	0.6	1,000	200	2,000	200	2,000	9.8	7.0	4.2	7.5	5.0/7.5	0.6	1,000	200	2,000	200	2,000										
473	0.047	7.3	7.0	4.0	5.0	5.0	0.6	1,000	200	2,000	200	2,000	9.8	7.2	4.2	7.5	5.0/7.5	0.6	1,000	200	1,600	200	1,600										
583	0.058	7.3	7.2	4.3	5.0	5.0	0.6	1,000	200	2,000	200	2,000	9.8	8.0	4.2	7.5	5.0/7.5	0.6	1,000	200	1,600	200	1,600										
683	0.068	7.3	7.5	4.6	5.0	5.0	0.6	1,000	200	2,000	200	2,000	9.8	8.3	4.4	7.5	5.0/7.5	0.6	1,000	100	1,500	100	1,500										
823	0.082	7.3	8.0	5.0	5.0	5.0	0.6	1,000	200	2,000	200	2,000	9.8	8.8	4.8	7.5	5.0/7.5	0.6	1,000	100	1,500	100	1,500										
104	0.10	7.3	8.5	5.5	5.0	5.0	0.6	1,000	200	2,000	200	2,000	9.8	10.8	4.5	7.5	5.0/7.5	0.6	1,000	100	1,000	100	1,000										
124	0.12	7.3	10.2	5.0	5.0	5.0	0.6	1,000	200	2,000	200	2,000	12.5	10.5	4.2	10.0	5.0/7.5	0.5	1,000	100	1,000	100	1,000										
154	0.15	7.3	11.5	6.0	5.0	5.0	0.6	1,000	200	2,000	200	2,000	12.5	10.7	4.6	10.0	5.0/7.5	0.6	1,000	100	1,000	100	1,000										
184	0.18	9.8	11.0	4.8	7.5	5.0/7.5	0.6	1,000	100	1,500	100	1,500	12.5	10.0	5.5	10.0	5.0/7.5	0.6	1,000	100	1,000	100	1,000										
224	0.22	9.8	11.3	5.0	7.5	5.0/7.5	0.6	1,000	100	1,500	100	1,500	12.5	10.5	5.8	10.0	5.0/7.5	0.6	1,000	100	1,000	100	1,000										
274	0.27	9.8	12.0	6.5	7.5	5.0/7.5	0.6	1,000	100	1,500	100	1,500	12.5	13.5	5.2	10.0	5.0/7.5	0.6	1,000	100	500	100	500										
334	0.33	9.8	12.5	6.0	7.5	5.0/7.5	0.6	1,000	100	1,500	100	1,500	12.5	14.3	5.8	10.0	5.0/7.5	0.6	1,000	100	500	100	500										
394	0.39	12.5	14.0	4.3	10.0	5.0/7.5/10.0	0.6	1,000	100	1,000	100	1,000	12.5	14.5	6.3	10.0	5.0/7.5	0.6	500	50	500	50	500										
474	0.47	12.5	14.4	4.8	10.0	5.0/7.5/10.0	0.6	1,000	100	1,000	100	1,000	12.5	15.5	7.0	10.0	5.0/7.5	0.6	500	50	500	50	500										
584	0.58	12.5	14.8	5.2	10.0	5.0/7.5/10.0	0.6	1,000	100	500	100	500	17.8	14.3	6.0	15.0	5.0/7.5/15.0	0.6	500	50	500	50	500										
684	0.68	12.5	15.2	5.8	10.0	5.0/7.5/10.0	0.6	1,000	100	500	100	500	17.8	14.8	6.5	15.0	5.0/7.5/15.0	0.8	400	50	500	50	500										
824	0.82	15.0	15.4	5.5	12.5	7.5/10.0/12.5	0.6	500	100	500	100	500	17.8	15.5	7.0	15.0	5.0/7.5/15.0	0.8	400	50	500	50	500										
105	1.0	15.0	16.0	6.2	12.5	7.5/10.0/12.5	0.6	400	100	500	100	500	17.8	16.3	7.5	15.0	5.0/7.5/15.0	0.8	400	50	400	50	400										
125	1.2	15.0	16.5	6.3	12.5	7.5/10.0/12.5	0.6	400	100	500	100	500	17.8	17.0	8.5	15.0	5.0/7.5/15.0	0.8	300	50	400	50	400										
155	1.5	15.0	17.5	7.8	12.5	7.5/10.0/12.5	0.6	400	100	500	100	500	25.5	16.0	7.8	22.5	17.5/22.5	0.8		50	200	50	200										
185	1.8	20.2	18.0	8.6	17.5	7.5/10.0/12.5	0.8	400	50	250	50	250	25.5	17.0	8.3	22.5	17.5/22.5	0.8		50	200	50	200										
225	2.2	20.3	17.8	7.3	17.5	7.5/10.0/12.5	0.8	400	50	250	50	250	25.5	18.8	8.8	22.5	17.5/22.5	0.8		50	200	50	200										
275	2.7	20.3	18.6	8.3	17.5	7.5/10.0/12.5	0.8	300	50	200	50	200	25.5	19.8	10.0	22.5	17.5/22.5	0.8		20	100	20	100										
335	3.3	20.3	21.0	9.0	17.5	7.5/10.0/12.5	0.8	300	50	200	50	200	25.5	21.0	11.0	22.5	17.5/22.5	0.8		20	100	20	100										
395	3.9	20.3	21.8	9.8	17.5	7.5/10.0/12.5	0.8	300	50	200	50	200	25.5	22.0	12.0	22.5	17.5/22.5	0.8		20	100	20	100										
475	4.7	20.3	23.8	10.7	17.5	7.5/10.0/12.5	0.8		50	200	50	200	25.5	23.6	12.5	22.5	17.5/22.5	0.8		20	100	20	100										
585	5.8	25.5	23.5	12.0	22.5	17.5/22.5	0.8		20	100	20	100																					
825	8.2	25.5	25.0	13.3	22.5	17.5/22.5	0.8		20	100	20	100																					
106	10.0	25.5	27.5	13.8	22.5	17.5/22.5	0.8																										

寸法/Dimensions (mm)

Cap CODE	Cap (μF)	MMX 450Vdc											
		基本収納数 NUMBER OF PIECES FOR PACKING UNIT						テーピング				フォーミング	
		W	H	T	P	F	φ d	Amco	Bag	Box	Bag	Box	
104	0.10	9.8	10.8	4.5	7.5	5.0/7.5	0.6	1,000	100	1,000	100	1,000	
124	0.12	12.5	10.5	4.2	10.0	5.0/7.5	0.6	1,000	100	1,000	100	1,000	
154	0.15	12.5	10.7	4.6	10.0	5.0/7.5	0.6	1,000	100	1,000	100	1,000	
184	0.18	12.5	10.0	5.5	10.0	5.0/7.5	0.6	1,000	100	1,000	100	1,000	
224	0.22	12.5	10.5	5.8	10.0	5.0/7.5	0.6	1,000	100	1,000	100	1,000	
274	0.27	12.5	13.5	5.2	10.0	5.0/7.5	0.6	1,000	100	500	100	500	
334	0.33	12.5	14.3	5.8	10.0	5.0/7.5	0.6	1,000	100	500	100	500	
394	0.39	12.5	14.5	6.3	10.0	5.0/7.5	0.6	500	50	500	50	500	
474	0.47	12.5	15.5	7.0	10.0	5.0/7.5	0.6	500	50	500	50	500	
564	0.56	17.8	14.3	6.0	15.0	5.0/7.5/15.0	0.6	500	50	500	50	500	
684	0.68	17.8	14.8	6.5	15.0	5.0/7.5/15.0	0.8	400	50	500	50	500	
824	0.82	17.8	15.5	7.0	15.0	5.0/7.5/15.0	0.8	400	50	500	50	500	
105	1.0	17.8	16.3	7.5	15.0	5.0/7.5/15.0	0.8	400	50	400	50	400	
125	1.2	17.8	17.0	8.5	15.0	5.0/7.5/15.0	0.8	300	50	400	50	400	
155	1.5	25.5	16.0	7.8	22.5	17.5/22.5	0.8		50	200	50	200	
185	1.8	25.5	17.0	8.3	22.5	17.5/22.5	0.8		50	200	50	200	
225	2.2	25.5	18.8	8.8	22.5	17.5/22.5	0.8		50	200	50	200	
275	2.7	25.5	19.8	10.0	22.5	17.5/22.5	0.8		20	100	20	100	
335	3.3	25.5	21.0	11.0	22.5	17.5/22.5	0.8		20	100	20	100	
395	3.9	25.5	22.0	12.0	22.5	17.5/22.5	0.8		20	100	20	100	
475	4.7	25.5	23.6	12.5	22.5	17.5/22.5	0.8		20	100	20	100	

Cap CODE	Cap (μF)	MMX 630Vdc											
		基本収納数 NUMBER OF PIECES FOR PACKING UNIT						テーピング				フォーミング	
		W	H	T	P	F	φ d	Amco	Bag	Box	Bag	Box	
102	0.0010	9.8	5.5	3.5	7.5	5.0/7.5	0.6	2,000	200	2,000	200	2,000	
122	0.0012	9.8	5.5	3.5	7.5	5.0/7.5	0.6	2,000	200	2,000	200	2,000	
152	0.0015	9.8	5.5	3.5	7.5	5.0/7.5	0.6	2,000	200	2,000	200	2,000	
182	0.0018	9.8	5.5	3.5	7.5	5.0/7.5	0.6	2,000	200	2,000	200	2,000	
222	0.0022	9.8	5.5	3.5	7.5	5.0/7.5	0.6	2,000	200	2,000	200	2,000	
272	0.0027	9.8	5.6	3.5	7.5	5.0/7.5	0.6	2,000	200	2,000	200	2,000	
332	0.0033	9.8	6.0	4.2	7.5	5.0/7.5	0.6	1,000	200	2,000	200	2,000	
392	0.0039	9.8	6.0	4.2	7.5	5.0/7.5	0.6	1,000	200	2,000	200	2,000	
472	0.0047	9.8	6.0	4.2	7.5	5.0/7.5	0.6	1,000	200	2,000	200	2,000	
562	0.0056	9.8	6.5	4.2	7.5	5.0/7.5	0.6	1,000	200	2,000	200	2,000	
682	0.0068	9.8	6.5	4.4	7.5	5.0/7.5	0.6	1,000	200	2,000	200	2,000	
822	0.0082	9.8	6.8	4.4	7.5	5.0/7.5	0.6	1,000	200	2,000	200	2,000	
103	0.010	9.8	7.7	4.2	7.5	5.0/7.5	0.6	1,000	200	2,000	200	2,000	
123	0.012	9.8	7.7	4.2	7.5	5.0/7.5	0.6	1,000	200	2,000	200	2,000	
153	0.015	9.8	8.0	4.2	7.5	5.0/7.5	0.6	1,000	200	2,000	200	2,000	
183	0.018	9.8	8.3	4.4	7.5	5.0/7.5	0.6	1,000	200	2,000	200	2,000	
223	0.022	9.8	8.3	5.0	7.5	5.0/7.5	0.6	1,000	200	1,600	200	1,600	
273	0.027	9.8	8.7	5.5	7.5	5.0/7.5	0.6	1,000	200	1,600	200	1,600	
333	0.033	9.8	11.3	5.0	7.5	5.0/7.5	0.6	1,000	100	1,500	100	1,500	
393	0.039	9.8	11.5	5.3	7.5	5.0/7.5	0.6	1,000	100	1,500	100	1,500	
473	0.047	9.8	11.0	6.3	7.5	5.0/7.5	0.6	1,000	100	1,000	100	1,000	
563	0.056	12.5	10.0	5.5	10.0	5.0/7.5/10.0	0.6	1,000	100	1,000	100	1,000	
683	0.068	12.5	10.5	5.8	10.0	5.0/7.5/10.0	0.6	1,000	100	1,000	100	1,000	
823	0.082	12.5	10.8	6.0	10.0	5.0/7.5/10.0	0.6	1,000	100	1,000	100	1,000	
104	0.10	12.5	13.8	5.8	10.0	5.0/7.5/10.0	0.6	1,000	100	500	100	500	
124	0.12	12.5	14.3	6.3	10.0	5.0/7.5/10.0	0.6	1,000	60	500	50	500	
154	0.15	12.5	13.8	7.7	10.0	5.0/7.5/10.0	0.6	500	50	500	50	500	
184	0.18	12.5	15.0	8.3	10.0	5.0/7.5/10.0	0.6	500	50	500	50	500	
224	0.22	12.5	15.8	9.0	10.0	5.0/7.5/10.0	0.6	500	50	500	50	500	
274	0.27	17.8	14.3	7.5	15.0	5.0/7.5/15.0	0.6	400	50	400	50	400	
334	0.33	17.8	14.8	8.0	15.0	5.0/7.5/15.0	0.8	300	50	400	50	400	
394	0.39	17.8	16.6	8.0	15.0	5.0/7.5/15.0	0.8	300	50	400	50	400	
474	0.47	17.8	17.3	9.0	15.0	5.0/7.5/15.0	0.8	300	50	400	50	400	
564	0.56	17.8	19.3	9.5	15.0	5.0/7.5/15.0	0.8	300	50	200	50	200	
684	0.68	17.8	20.3	10.5	15.0	5.0/7.5/15.0	0.8		50	200	50	200	
824	0.82	25.5	19.8	8.5	22.5	17.5/22.5	0.8		20	100	20	100	
105	1.0	25.5	20.8	9.5	22.5	17.5/22.5	0.8		20	100	20	100	
125	1.2	25.5	21.8	10.5	22.5	17.5/22.5	0.8		20	100	20	100	
155	1.5	25.5	23.0	11.8	22.5	17.5/22.5	0.8		20	100	20	100	
185	1.8	25.5	24.3	13.5	22.5	17.5/22.5	0.8		20	100	20	100	
225	2.2	25.5	26.8	14.3	22.5	17.5/22.5	0.8		20	100	20	100	

形状 Style	ストレートリード Straight lead type		フォーミング Forming lead type		
	W _{Max}	T _{Max}	F=5.0	F=10.0	
Cap 範囲 Cap range	250Vdc	102~106	F= 5.0	102~334	394~684
			F= 7.5	184~684	824~475
			F=10.0	394~155	185~475
			F=12.5	824~155	185~475
			F=17.5		565~106
			F=22.5	565~106	
	400Vdc	102~475	F= 5.0	102~104	124~125
			F= 7.5	102~474	564~125
			F=10.0	124~474	
			F=15.0	564~125	
			F=17.5		155~475
			F=22.5	155~475	
450Vdc	104~225	F= 5.0	104	124~125	
		F= 7.5	104~474	564~125	
		F=10.0	124~474		
		F=15.0	564~125		
		F=17.5		155~225	
		F=22.5	155~225		
630Vdc	102~225	F= 5.0	102~473	563~684	
		F= 7.5	102~224	274~684	
		F=10.0	563~224		
		F=15.0	274~684		
		F=17.5		824~225	
		F=22.5	824~225		

テーピング仕様のリードピッチ寸法(F)は、6~7頁のテーピング 寸法表をご参照下さい。
For a pitch space (F) of the taping specification, refer to "TAPING DIMENSIONS" on pages 6 to 7.

ご使用にあたっては、使用上の注意事項(9-16頁)をご確認の上、技術仕様書等をお求め願ひ、仕様書の範囲内でのご使用をお願いします。

周波数に対する許容電流特性 / Characteristics of permissible current to frequency

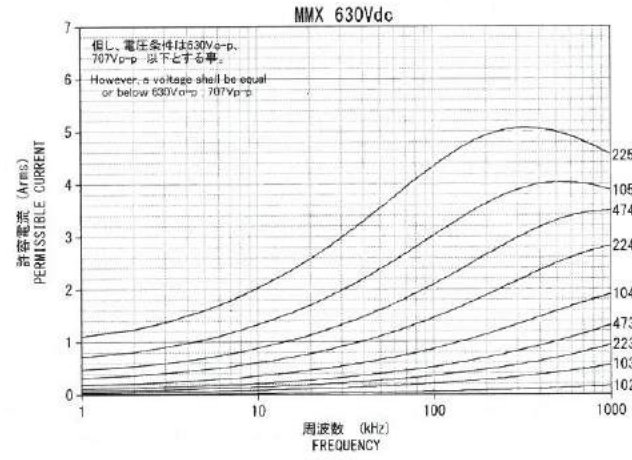
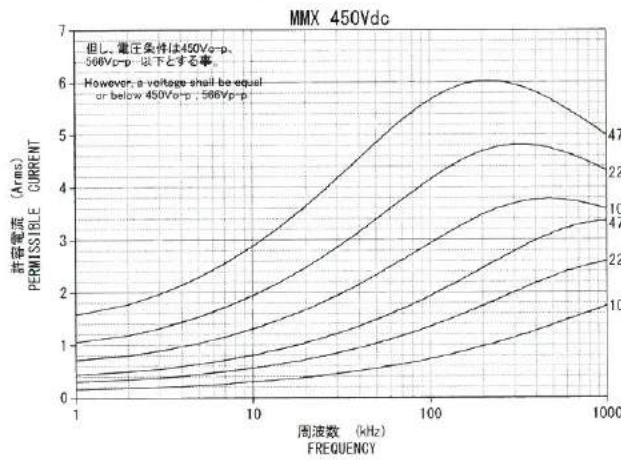
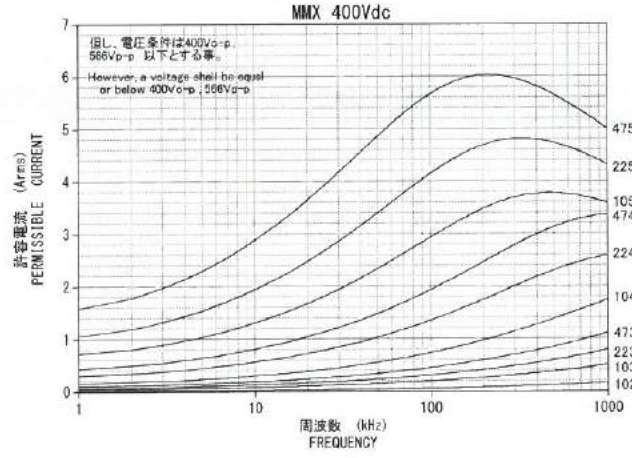
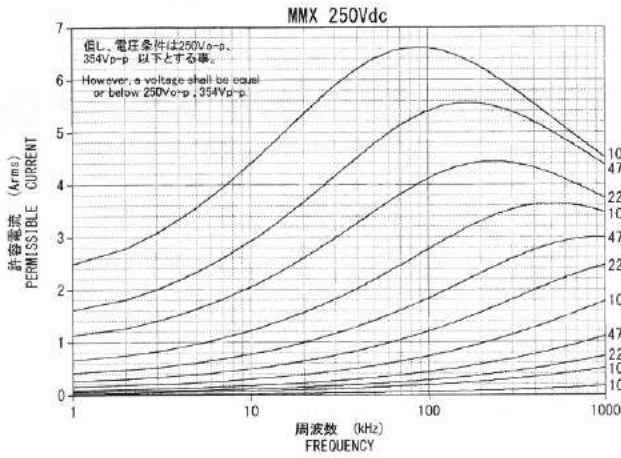

ご使用にあたっては、使用上の注意事項(9-16頁)をご確認の上、技術仕様書等をお求め願ひ、仕様書の範囲内でのご使用をお願いします。

When using our capacitors, please consider the application notes on pages 9-16 and contact NISSEI for any additional technical specifications relating to the limits of our performance characteristics.

特徴/Features

- MMHタイプを更に、小型化した製品です。
- 自己回復作用があるため、信頼性に優れております。
- 外装は最新のエポキシ加工により難燃性のエポキシ樹脂による均一な厚さで覆われていますので小型軽量となっています。

- ★Smaller version of MMH type.
- ★Highly reliable because of its self-healing performance.
- ★Uniform flame-retardant epoxy resin coating through the latest resin technology. This provides miniature size and light weight.

規格/Specifications

使用温度範囲 Temp. range	-40~+85°C (+105°C)※1	絶縁抵抗 Insulation resistance	C ≤ 0.33 μF 15,000M Ω _{100Vdc} C > 0.33 μF 5,000 Ω F _{100Vdc}
定格電圧 Rated voltage	100V, 250V, 400V, 450V, 630V, 1000V, 1250Vdc	高温負荷 Endurance	85°C WV × 125% 1000hr印加 ※3 ΔC/C ± 5% _{100Vdc} in tan δ 0.01 _{100Vdc} IR C ≤ 0.33 μF 2,700M Ω _{100Vdc} C > 0.33 μF 900 Ω F _{100Vdc}
静電容量範囲 Capacitance	100V 0.033~4.7 μF 250V 0.0010~10 μF 400V 0.0010~4.7 μF 450V 0.0010~3.3 μF 630V 0.0010~2.2 μF 1000V 0.0010~0.47 μF 1250V 0.0010~0.22 μF (各定格 E-12シリーズ)	耐湿負荷 Damp heat	40°C 90~95%RH WV 500hr印加 ΔC/C ± 7% _{100Vdc} in tan δ 0.01 _{100Vdc} IR C ≤ 0.33 μF 2,700M Ω _{100Vdc} C > 0.33 μF 900 Ω F _{100Vdc}
静電容量許容差 Cap. tolerance	±5%(J), ±10%(K)		
誘電正接 Tangent of loss angle	0.008 _{100Vdc} (at 1kHz)		

※1 () 温度は電圧軽減による使用可能範囲です。

※1 () Marked temperature shows operatable when voltage is derated.

形状 Style	ストレートリード Straight lead type			フォーミング Forming lead type						
	W Max	T Max	H Max	F ± 0.5	F ± 0.5	F ± 0.5	F ± 0.5	F ± 0.5	F ± 0.5	
1.5 Max										
			20 Min							
Cap範囲 Cap range	100Vdc	333~475		333~474	333~105	564~105	125~225	275~475	564~225	125~225

テーピング仕様のリードピッチ寸法(F)は、6~7頁のテーピング寸法表をご参照下さい。
For a pitch space (F) of the taping specification, refer to "TAPING DIMENSIONS" on pages 6 to 7.

寸法/Dimensions (mm)

Cap CODE	Cap (μF)	MMC 100Vdc							基本収納数 NUMBER OF PIECES FOR PACKING UNIT			
		W	H	T	P	F	φd	テーピング Taping	ロング Long	フォーミング Formed	Bag	Box
333	0.033	9.5	5.5	3.5	7.5	5.0/7.5	0.5	2,000	200	4,000	200	5,000
393	0.039	9.5	5.5	3.5	7.5	5.0/7.5	0.5	2,000	200	4,000	200	5,000
473	0.047	9.5	5.5	3.5	7.5	5.0/7.5	0.5	2,000	200	4,000	200	5,000
563	0.056	9.5	5.5	3.5	7.5	5.0/7.5	0.5	2,000	200	4,000	200	5,000
683	0.068	9.5	5.5	3.5	7.5	5.0/7.5	0.5	2,000	200	4,000	200	5,000
823	0.082	9.5	5.5	3.5	7.5	5.0/7.5	0.5	2,000	200	3,000	200	5,000
104	0.10	10.0	7.0	3.8	7.5	5.0/7.5	0.5	2,000	200	3,000	200	4,000
124	0.12	10.0	7.0	3.8	7.5	5.0/7.5	0.5	2,000	200	3,000	200	4,000
154	0.15	10.0	8.0	4.0	7.5	5.0/7.5	0.5	2,000	200	2,000	200	4,000
184	0.18	10.0	8.0	4.0	7.5	5.0/7.5	0.5	1,000	200	2,000	200	4,000
224	0.22	10.0	8.0	4.5	7.5	5.0/7.5	0.5	1,000	200	2,000	200	3,000
274	0.27	10.0	9.0	4.5	7.5	5.0/7.5	0.5	1,000	200	2,000	200	3,000
334	0.33	10.0	11.0	4.5	7.5	5.0/7.5	0.5	1,000	200	2,000	200	2,000
394	0.39	10.0	11.5	5.0	7.5	5.0/7.5	0.5	1,000	100	1,500	200	2,000
474	0.47	10.0	12.0	5.3	7.5	5.0/7.5	0.5	1,000	100	1,500	200	2,000
564	0.56	12.5	10.5	5.3	10.0	5.0/7.5/10.0	0.6	1,000	100	1,000	100	1,500
684	0.68	12.5	10.5	6.4	10.0	5.0/7.5/10.0	0.6	500	100	1,000	100	1,500
824	0.82	12.5	13.5	5.7	10.0	5.0/7.5/10.0	0.6	500	100	1,000	100	1,000
105	1.0	12.5	14.0	6.0	10.0	5.0/7.5/10.0	0.6	500	100	1,000	100	1,000
125	1.2	14.0	12.0	5.5	15.0	5.0/7.5/15.0	0.8	500	50	500	100	1,000
155	1.5	18.0	13.0	6.0	15.0	5.0/7.5/15.0	0.8	500	50	500	100	1,000
185	1.8	18.0	13.5	6.5	15.0	5.0/7.5/15.0	0.8	400	50	500	50	500
225	2.2	18.0	14.0	7.3	15.0	5.0/7.5/15.0	0.8	400	50	500	50	500
275	2.7	25.0	13.5	6.5	22.5	22.5	0.8		50	250	50	500
335	3.3	25.0	15.0	7.0	22.5	22.5	0.8		50	250	50	500
395	3.9	25.0	16.0	7.5	22.5	22.5	0.8		50	250	50	500
475	4.7	25.0	17.0	8.0	22.5	22.5	0.8		50	250	50	250

周波数に対する許容電流特性

Characteristics of permissible current to frequency

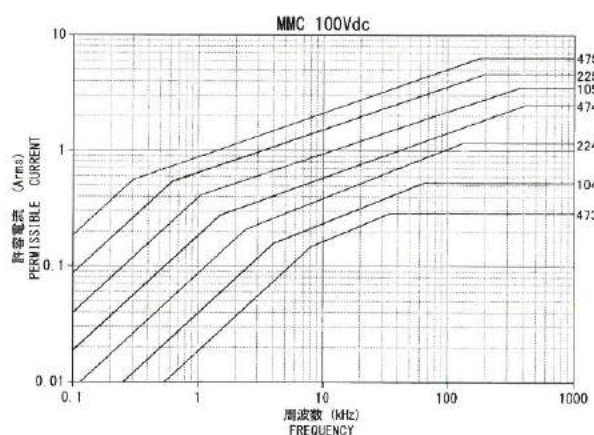

ご使用にあたっては、使用上の注意事項(9-16頁)をご確認の上、技術仕様書等をお求め願ひ、仕様書の範囲内でのご使用をお願いします。 When using our capacitors, please consider the application notes on pages 9-16 and contact NISSEI for any additional technical specifications relating to the limits of our performance characteristics.

形状 Style	ストレートリード Straight lead type		フォーミング Forming lead type							
Cap 範囲	250Vdc	102~106	F=5.0	F=7.5	F=10.0	F=15.0	F=22.5	F=27.5	F=5.0	F=7.5
Cap range	400Vdc	102~475	102~154	102~334	184~334	394~155	185~475	565~106	184~125	394~155
			102~333	102~104	393~104	124~474	564~125	155~475	393~474	124~474

テーピング仕様のリードピッチ寸法(F)は、6~7頁のテーピング寸法表をご参照下さい。
For a pitch space (F) of the taping specification, refer to "TAPING DIMENSIONS" on page 6 to 7.

寸法/Dimensions (mm)

Cap CODE	Cap (μF)	MMC 250Vdc															MMC 400Vdc																			
		基準収納数 NUMBER OF PIECES FOR PACKING UNIT							基準収納数 NUMBER OF PIECES FOR PACKING UNIT								基準収納数 NUMBER OF PIECES FOR PACKING UNIT							基準収納数 NUMBER OF PIECES FOR PACKING UNIT												
		W	H	T	P	F	φd	Ammo	テーピング Taping	ロング Long	フォーミング Forming	W	H	T	P	F	φd	Ammo	テーピング Taping	ロング Long	フォーミング Forming	W	H	T	P	F	φd	Ammo	テーピング Taping	ロング Long	フォーミング Forming					
102	0.0010	10.3	7.0	4.0	7.5	5.0/7.5	0.6	1,000	200	2,000	200	2,000	10.3	7.0	4.0	7.5	5.0/7.5	0.6	1,000	200	2,000	200	2,000	10.3	7.0	4.0	7.5	5.0/7.5	0.6	1,000	200	2,000	200	2,000		
122	0.0012	10.3	7.0	4.0	7.5	5.0/7.5	0.6	1,000	200	2,000	200	2,000	10.3	7.0	4.0	7.5	5.0/7.5	0.6	1,000	200	2,000	200	2,000	10.3	7.0	4.0	7.5	5.0/7.5	0.6	1,000	200	2,000	200	2,000		
152	0.0015	10.3	7.0	4.0	7.5	5.0/7.5	0.6	1,000	200	2,000	200	2,000	10.3	7.0	4.0	7.5	5.0/7.5	0.6	1,000	200	2,000	200	2,000	10.3	7.0	4.0	7.5	5.0/7.5	0.6	1,000	200	2,000	200	2,000		
182	0.0018	10.3	7.0	4.0	7.5	5.0/7.5	0.6	1,000	200	2,000	200	2,000	10.3	7.0	4.0	7.5	5.0/7.5	0.6	1,000	200	2,000	200	2,000	10.3	7.0	4.0	7.5	5.0/7.5	0.6	1,000	200	2,000	200	2,000		
222	0.0022	10.3	7.0	4.0	7.5	5.0/7.5	0.6	1,000	200	2,000	200	2,000	10.3	7.0	4.0	7.5	5.0/7.5	0.6	1,000	200	2,000	200	2,000	10.3	7.0	4.0	7.5	5.0/7.5	0.6	1,000	200	2,000	200	2,000		
272	0.0027	10.3	7.0	4.0	7.5	5.0/7.5	0.6	1,000	200	2,000	200	2,000	10.3	7.0	4.0	7.5	5.0/7.5	0.6	1,000	200	2,000	200	2,000	10.3	7.0	4.0	7.5	5.0/7.5	0.6	1,000	200	2,000	200	2,000		
332	0.0033	10.3	7.0	4.0	7.5	5.0/7.5	0.6	1,000	200	2,000	200	2,000	10.3	7.0	4.0	7.5	5.0/7.5	0.6	1,000	200	2,000	200	2,000	10.3	7.0	4.0	7.5	5.0/7.5	0.6	1,000	200	2,000	200	2,000		
392	0.0039	10.3	7.0	4.0	7.5	5.0/7.5	0.6	1,000	200	2,000	200	2,000	10.3	7.0	4.0	7.5	5.0/7.5	0.6	1,000	200	2,000	200	2,000	10.3	7.0	4.0	7.5	5.0/7.5	0.6	1,000	200	2,000	200	2,000		
472	0.0047	10.3	7.0	4.0	7.5	5.0/7.5	0.6	1,000	200	2,000	200	2,000	10.3	7.0	4.0	7.5	5.0/7.5	0.6	1,000	200	2,000	200	2,000	10.3	7.0	4.0	7.5	5.0/7.5	0.6	1,000	200	2,000	200	2,000		
562	0.0056	10.3	7.0	4.0	7.5	5.0/7.5	0.6	1,000	200	2,000	200	2,000	10.3	7.0	4.0	7.5	5.0/7.5	0.6	1,000	200	2,000	200	2,000	10.3	7.0	4.0	7.5	5.0/7.5	0.6	1,000	200	2,000	200	2,000		
682	0.0068	10.3	7.0	4.0	7.5	5.0/7.5	0.6	1,000	200	2,000	200	2,000	10.3	7.0	4.0	7.5	5.0/7.5	0.6	1,000	200	2,000	200	2,000	10.3	7.0	4.0	7.5	5.0/7.5	0.6	1,000	200	2,000	200	2,000		
822	0.0082	10.3	7.0	4.0	7.5	5.0/7.5	0.6	1,000	200	2,000	200	2,000	10.3	7.0	4.0	7.5	5.0/7.5	0.6	1,000	200	2,000	200	2,000	10.3	7.0	4.0	7.5	5.0/7.5	0.6	1,000	200	2,000	200	2,000		
103	0.010	10.3	7.4	4.3	7.5	5.0/7.5	0.6	1,000	200	2,000	200	2,000	10.3	7.6	4.4	7.5	5.0/7.5	0.6	1,000	200	2,000	200	2,000	10.3	7.6	4.4	7.5	5.0/7.5	0.6	1,000	200	2,000	200	2,000		
123	0.012	10.3	7.4	4.4	7.5	5.0/7.5	0.6	1,000	200	2,000	200	2,000	10.3	7.8	4.4	7.5	5.0/7.5	0.6	1,000	200	2,000	200	2,000	10.3	7.8	4.4	7.5	5.0/7.5	0.6	1,000	200	2,000	200	2,000		
153	0.015	10.3	7.5	4.4	7.5	5.0/7.5	0.6	1,000	200	2,000	200	2,000	10.3	7.8	4.4	7.5	5.0/7.5	0.6	1,000	200	2,000	200	2,000	10.3	7.8	4.4	7.5	5.0/7.5	0.6	1,000	200	2,000	200	2,000		
183	0.018	10.3	7.5	4.4	7.5	5.0/7.5	0.6	1,000	200	2,000	200	2,000	10.3	7.6	4.4	7.5	5.0/7.5	0.6	1,000	200	2,000	200	2,000	10.3	7.6	4.4	7.5	5.0/7.5	0.6	1,000	200	2,000	200	2,000		
223	0.022	10.3	7.5	4.4	7.5	5.0/7.5	0.6	1,000	200	2,000	200	2,000	10.3	7.9	4.5	7.5	5.0/7.5	0.6	1,000	200	2,000	200	2,000	10.3	7.9	4.5	7.5	5.0/7.5	0.6	1,000	200	2,000	200	2,000		
273	0.027	10.3	7.5	4.4	7.5	5.0/7.5	0.6	1,000	200	2,000	200	2,000	10.3	8.2	4.8	7.5	5.0/7.5	0.6	1,000	200	2,000	200	2,000	10.3	8.2	4.8	7.5	5.0/7.5	0.6	1,000	200	2,000	200	2,000		
333	0.033	10.3	7.5	4.4	7.5	5.0/7.5	0.6	1,000	200	2,000	200	2,000	10.3	9.0	5.5	7.5	5.0/7.5	0.6	1,000	200	2,000	200	2,000	10.3	9.0	5.5	7.5	5.0/7.5	0.6	1,000	200	2,000	200	2,000		
393	0.039	10.3	7.5	4.5	7.5	5.0/7.5	0.6	1,000	200	2,000	200	2,000	12.5	8.0	4.9	10.0	5.0/7.5/10.0	0.6	1,000	200	1,600	200	1,600	12.5	8.0	4.9	10.0	5.0/7.5/10.0	0.6	1,000	200	1,600	200	1,600		
473	0.047	10.3	7.9	4.4	7.5	5.0/7.5	0.6	1,000	200	2,000	200	2,000	12.5	8.3	5.2	10.0	5.0/7.5/10.0	0.6	1,000	200	1,600	200	1,600	12.5	8.3	5.2	10.0	5.0/7.5/10.0	0.6	1,000	200	1,600	200	1,600		
563	0.056	10.3	7.9	4.8	7.5	5.0/7.5	0.6	1,000	200	2,000	200	2,000	12.5	10.0	5.2	10.0	5.0/7.5/10.0	0.6	1,000	200	1,600	200	1,600	12.5	10.0	5.2	10.0	5.0/7.5/10.0	0.6	1,000	200	1,600	200	1,600		
683	0.068	10.3	7.5	4.5	7.5	5.0/7.5	0.6	1,000	200	2,000	200	2,000	12.5	10.5	5.5	10.0	5.0/7.5/10.0	0.6	1,000	100	1,500	100	1,500	12.5	10.5	5.5	10.0	5.0/7.5/10.0	0.6	1,000	100	1,500	100	1,500		
823	0.082	10.3	8.0	4.8	7.5	5.0/7.5	0.6	1,000	200	2,000	200	2,000	12.5	11.0	6.0	10.0	5.0/7.5/10.0	0.6	1,000	100	1,500	100	1,500	12.5	11.0	6.0	10.0	5.0/7.5/10.0	0.6	1,000	100	1,500	100	1,500		
104	0.10	10.3	8.4	5.8	7.5	5.0/7.5	0.6	1,000	200	2,000	200	2,000	12.5	12.0	6.0	10.0	5.0/7.5/10.0	0.6	1,000	100	1,000	100	1,000	12.5	12.0	6.0	10.0	5.0/7.5/10.0	0.6	1,000	100	1,000	100	1,000		
124	0.12	10.3	9.0	6.0	7.5	5.0/7.5	0.6	1,000	200	2,000	200	2,000	18.0	10.2	5.5	15.0	5.0/7.5/15.0	0.6	500	100	1,000	100	1,000	18.0	10.2	5.5	15.0	5.0/7.5/15.0	0.6	500	100	1,000	100	1,000		
154	0.15	10.3	10.8	6.0	7.5	5.0/7.5	0.6	1,000	200	2,000	200	2,000	18.0	12.0	5.5	15.0	5.0/7.5/15.0	0.6	500	100	1,000	100	1,000	18.0	12.0	5.5	15.0	5.0/7.5/15.0	0.6	500	100	1,000	100	1,000		
184	0.18	12.5	10.0	5.0	10.0	5.0/7.5/10.0	0.6	1,000	100	1,500	100	1,500	18.0	12.5	6.0	15.0	5.0/7.5/15.0	0.6	500	100	1,000	100	1,000	18.0	12.5	6.0	15.0	5.0/7.5/15.0	0.6	500	100	1,000	100	1,000		
224	0.22	12.5	10.3	5.5	10.0	5.0/7.5/10.0	0.6	1,000	100	1,500	100	1,500	18.0	13.0	6.5	15.0	5.0/7.5/15.0	0.6	400	100	500	100	500	18.0	13.0	6.5	15.0	5.0/7.5/15.0	0.6	400	100	500	100	500		
274	0.27	12.5	11.0	6.0	10.0	5.0/7.5/10.0	0.6	1,000	100	1,500	100	1,500	18.0	13.5	7.0	15.0	5.0/7.5/15.0	0.8	400	100	500	100	500	18.0	13.5	7.0	15.0	5.0/7.5/15.0	0.8	400	100	500	100	500		
334	0.33	12.5	11.5	6.5	10.0	5.0/7.5/10.0	0.6	500	100	1,500	100	1,500	18.0	14.0	7.7	15.0	5.0/7.5/15.0	0.8	300	100	500	100	500	18.0	14.0	7.7	15.0	5.0/7.5/15.0	0.8	300	100	500	100	500		
394	0.39	18.0	12.0	4.9	15.0	5.0/7.5/15.0	0.6	500	100	1,000	100	1,000	18.0	15.0	8.5	15.0	5.0/7.5/15.0	0.8	300	50	500	50	500	18.0	15.0	8.5	15.0	5.0/7.5/15.0	0.8	300	50	500	50	500		
474	0.47	18.0	12.5	5.3	15.0	5.0/7.5/15.0	0.6	500	100	1,000	100	1,000	18.0	16.5	8.5	15.0	5.0/7.5/15.0	0.8	300	50	400	50	400	18.0	16.5	8.5	15.0	5.0/7.5/15.0	0.8	300	50	400	50	400		
564	0.56	18.0	13.0	5.5	15.0	5.0/7.5/15.0	0.6	500	100	500	100	500	25.0	15.3	7.5	22.5	22.5	0.8			50	250	50	250	25.0	15.3	7.5	22.5	22.5	0.8			50	250	50	250

形状 Style	ストレートリード Straight lead type				フォーミング Forming lead type							
					F=5.0	F=7.5	F=10.0	F=15.0	F=22.5	F=27.5	F=5.0	F=7.5
Cap範囲	450Vdc	102~335	102~333	102~104	393~154	184~474	564~125	155~335	393~474	124~474		
Cap range	630Vdc	102~225	102~822	102~473	103~473	563~224	274~684	824~225	103~224	563~224		

テーピング仕様のリードピッチ寸法(F)は、6~7頁のテーピング寸法表をご参照下さい。
For a pitch space (F) of the taping specification, refer to "TAPING DIMENSIONS" on page 6 to 7.

寸法/Dimensions (mm)

Cap CODE	Cap (μF)	MMC 450Vdc										MMC 630Vdc											
		基準収納数 NUMBER OF PIECES FOR PACKING UNIT										基準収納数 NUMBER OF PIECES FOR PACKING UNIT											
		W	H	T	P	F	φd	テーピング Taping	ロング Long	フォーミング Formed	W	H	T	P	F	φd	テーピング Taping	ロング Long	フォーミング Formed				
102	0.0010	10.3	7.0	4.0	7.5	5.0/7.5	0.6	1,000	200	2,000	200	2,000	10.3	7.5	4.5	7.5	5.0/7.5	0.6	1,000	200	2,000	200	2,000
122	0.0012	10.3	7.0	4.0	7.5	5.0/7.5	0.6	1,000	200	2,000	200	2,000	10.3	7.5	4.5	7.5	5.0/7.5	0.6	1,000	200	2,000	200	2,000
152	0.0015	10.3	7.0	4.0	7.5	5.0/7.5	0.6	1,000	200	2,000	200	2,000	10.3	7.5	4.5	7.5	5.0/7.5	0.6	1,000	200	2,000	200	2,000
182	0.0018	10.3	7.0	4.0	7.5	5.0/7.5	0.6	1,000	200	2,000	200	2,000	10.3	7.5	4.5	7.5	5.0/7.5	0.6	1,000	200	2,000	200	2,000
222	0.0022	10.3	7.0	4.0	7.5	5.0/7.5	0.6	1,000	200	2,000	200	2,000	10.3	7.5	4.5	7.5	5.0/7.5	0.6	1,000	200	2,000	200	2,000
272	0.0027	10.3	7.0	4.0	7.5	5.0/7.5	0.6	1,000	200	2,000	200	2,000	10.3	7.5	4.5	7.5	5.0/7.5	0.6	1,000	200	2,000	200	2,000
332	0.0033	10.3	7.0	4.0	7.5	5.0/7.5	0.6	1,000	200	2,000	200	2,000	10.3	7.5	4.5	7.5	5.0/7.5	0.6	1,000	200	2,000	200	2,000
392	0.0039	10.3	7.0	4.0	7.5	5.0/7.5	0.6	1,000	200	2,000	200	2,000	10.3	7.5	4.5	7.5	5.0/7.5	0.6	1,000	200	2,000	200	2,000
472	0.0047	10.3	7.0	4.0	7.5	5.0/7.5	0.6	1,000	200	2,000	200	2,000	10.3	7.5	4.5	7.5	5.0/7.5	0.6	1,000	200	2,000	200	2,000
562	0.0056	10.3	7.0	4.0	7.5	5.0/7.5	0.6	1,000	200	2,000	200	2,000	10.3	7.5	4.5	7.5	5.0/7.5	0.6	1,000	200	2,000	200	2,000
682	0.0068	10.3	7.0	4.0	7.5	5.0/7.5	0.6	1,000	200	2,000	200	2,000	10.3	7.5	4.5	7.5	5.0/7.5	0.6	1,000	200	2,000	200	2,000
822	0.0082	10.3	7.0	4.0	7.5	5.0/7.5	0.6	1,000	200	2,000	200	2,000	10.3	7.5	4.5	7.5	5.0/7.5	0.6	1,000	200	2,000	200	2,000
103	0.010	10.3	7.6	4.4	7.5	5.0/7.5	0.6	1,000	200	2,000	200	2,000	12.5	7.5	4.0	10.0	5.0/7.5/10.0	0.6	1,000	200	2,000	200	2,000
123	0.012	10.3	7.8	4.4	7.5	5.0/7.5	0.6	1,000	200	2,000	200	2,000	12.5	7.5	4.5	10.0	5.0/7.5/10.0	0.6	1,000	200	2,000	200	2,000
153	0.015	10.3	7.8	4.4	7.5	5.0/7.5	0.6	1,000	200	2,000	200	2,000	12.5	8.2	5.0	10.0	5.0/7.5/10.0	0.6	1,000	200	2,000	200	2,000
183	0.018	10.3	7.6	4.4	7.5	5.0/7.5	0.6	1,000	200	2,000	200	2,000	12.5	10.0	5.0	10.0	5.0/7.5/10.0	0.6	1,000	200	2,000	200	2,000
223	0.022	10.3	7.9	4.5	7.5	5.0/7.5	0.6	1,000	200	2,000	200	2,000	12.5	10.5	5.3	10.0	5.0/7.5/10.0	0.6	1,000	200	1,600	200	1,600
273	0.027	10.3	8.2	4.8	7.5	5.0/7.5	0.6	1,000	200	2,000	200	2,000	12.5	10.5	5.5	10.0	5.0/7.5/10.0	0.6	1,000	200	1,600	200	1,600
333	0.033	10.3	9.0	5.5	7.5	5.0/7.5	0.6	1,000	200	2,000	200	2,000	12.5	11.0	6.0	10.0	5.0/7.5/10.0	0.6	1,000	100	1,500	100	1,500
393	0.039	12.5	8.0	4.9	10.0	5.0/7.5/10.0	0.6	1,000	200	1,500	200	1,500	12.5	12.5	6.0	10.0	5.0/7.5/10.0	0.6	1,000	100	1,500	100	1,500
473	0.047	12.5	8.3	5.2	10.0	5.0/7.5/10.0	0.6	1,000	200	1,600	200	1,600	12.5	13.0	6.5	10.0	5.0/7.5/10.0	0.6	500	100	1,000	100	1,000
563	0.056	12.5	10.0	5.2	10.0	5.0/7.5/10.0	0.6	1,000	200	1,600	200	1,600	18.0	10.5	5.5	15.0	5.0/7.5/15.0	0.6	500	100	1,000	100	1,000
683	0.068	12.5	10.5	5.5	10.0	5.0/7.5/10.0	0.6	1,000	100	1,500	100	1,500	18.0	11.0	6.0	15.0	5.0/7.5/15.0	0.6	500	100	1,000	100	1,000
823	0.082	12.5	11.0	6.0	10.0	5.0/7.5/10.0	0.6	1,000	100	1,500	100	1,500	18.0	11.5	6.5	15.0	5.0/7.5/15.0	0.6	400	100	1,000	100	1,000
104	0.10	12.5	12.0	6.0	10.0	5.0/7.5/10.0	0.6	1,000	100	1,000	100	1,000	18.0	13.0	6.5	15.0	5.0/7.5/15.0	0.6	400	100	500	100	500
124	0.12	18.0	10.2	5.5	15.0	5.0/7.5/10.0	0.6	500	100	1,000	100	1,000	18.0	13.5	7.0	15.0	5.0/7.5/15.0	0.8	400	50	500	50	500
154	0.15	18.0	12.0	5.5	15.0	5.0/7.5/10.0	0.6	500	100	1,000	100	1,000	18.0	14.5	8.0	15.0	5.0/7.5/15.0	0.8	300	50	500	50	500
184	0.18	18.0	12.5	6.0	15.0	5.0/7.5/15.0	0.6	500	100	1,000	100	1,000	18.0	16.0	8.0	15.0	5.0/7.5/15.0	0.8	300	50	500	50	500
224	0.22	18.0	13.0	6.5	15.0	5.0/7.5/15.0	0.6	400	100	500	100	500	18.0	16.5	9.0	15.0	5.0/7.5/15.0	0.8	300	50	500	50	250
274	0.27	18.0	13.5	7.0	15.0	5.0/7.5/15.0	0.8	400	100	500	100	500	25.0	16.8	7.5	22.5	22.5	0.8	50	250	50	250	
334	0.33	18.0	14.0	7.7	15.0	5.0/7.5/15.0	0.8	300	100	500	100	500	25.0	17.5	8.0	22.5	22.5	0.8	50	250	50	250	
394	0.39	18.0	15.0	8.5	15.0	5.0/7.5/15.0	0.8	300	50	500	50	500	25.0	18.0	9.7	22.5	22.5	0.8	50	150	50	150	
474	0.47	18.0	16.5	8.5	15.0	5.0/7.5/15.0	0.8	300	50	400	50	500	25.0	19.0	9.5	22.5	22.5	0.8	50	150	50	150	
564	0.56	25.0	15.3	7.5	22.5	22.5	0.8	50	250	50	250	25.0	20.0	10.5	22.5	22.5	0.8	50	150	50	150		
684	0.68	25.0	16.0	8.2	22.5	22.5	0.8	50	250	50	250	25.0	21.5	11.5	22.5	22.5	0.8	50	150	50	150		
824	0.82	25.0	16.8	9.0	22.5	22.5	0.8	50	250	50	250	30.0	20.0	10.5	27.5	27.5	0.8	20	100	20	100		
105	1.0	25.0	17.7	10.0	22.5	22.5	0.8	50	200	50	200	30.0	21.0	11.5	27.5	27.5	0.8	20	100	20	100		
125	1.2	25.0	18.8	11.0	22.5	22.5	0.8	50	200	50	200	30.0	22.0	12.5	27.5	27.5	0.8	20	100	20	100		
155	1.5	30.0	19.5	10.0	27.5	27.5	0.8	25	150	50	200	30.0	24.0	14.3	27.5	27.5	0.8	20	100	20	100		
185	1.8	30.0	21.5	11.0	27.5	27.5	0.8	20	100	50	200	30.0	25.5	15.5	27.5	27.5	0.8	20	80	20	100		
225	2.2	30.0	23.0	12.5	27.5	27.5	0.8	20	100	20	100	30.0	27.3	17.5	27.5	27.5	0.8	20	80	20	100		
275	2.7	30.0	25.0	14.0	27.5	27.5	0.8	20	100	20	100												
335	3.3	30.0	26.5	15.5	27.5	27.5	0.8	20	100	20	100												

ご使用にあたっては、使用上の注意事項(9-16頁)をご確認の上、技術仕様書等をお求め願ひ、仕様書の範囲内でのご使用をお願いします。 When using our capacitors, please consider the application notes on pages 9-16 and contact NISSEI for any additional technical specifications relating to the limits of our performance characteristics.

形状 Style	ストレートリード Straight lead type				フォーミング Forming lead type				
						F=10.0	F=12.5	F=12.5	F=17.5
Cap 範囲	100Vdc	102~474	102~682	822~223	273~104	124~274	334~474		
Cap range	1250Vdc	102~224	102~682	—	822~223	273~473	563~224		

テーピング仕様のリードピッチ寸法(F)は、6~7頁のテーピング寸法表をご参照下さい。
For a pitch space (F) of the taping specification, refer to "TAPING DIMENSIONS" on page 6 to 7.

寸法/Dimensions (mm)

Cap CODE	Cap (μF)	MMC 1000Vdc										MMC 1250Vdc																			
		基準収納数 NUMBER OF PIECES FOR PACKING UNIT								基準収納数 NUMBER OF PIECES FOR PACKING UNIT				基準収納数 NUMBER OF PIECES FOR PACKING UNIT				基準収納数 NUMBER OF PIECES FOR PACKING UNIT													
		W	H	T	P	F	φd	ロング Long	フォーミング Formed	W	H	T	P	F	φd	ロング Long	フォーミング Formed	W	H	T	P	F	φd	ロング Long	フォーミング Formed						
102	0.0010	15.5	11.0	6.0	12.5	10.0	0.6	100	1,500	100	1,500	15.5	11.0	6.0	12.5	10.0	0.6	100	1,500	100	1,500	15.5	11.0	6.0	12.5	10.0	0.6	100	1,500	100	1,500
122	0.0012	15.5	11.0	6.0	12.5	10.0	0.6	100	1,500	100	1,500	15.5	11.0	6.0	12.5	10.0	0.6	100	1,500	100	1,500	15.5	11.0	6.0	12.5	10.0	0.6	100	1,500	100	1,500
152	0.0015	15.5	11.0	6.0	12.5	10.0	0.6	100	1,500	100	1,500	15.5	11.0	6.0	12.5	10.0	0.6	100	1,500	100	1,500	15.5	11.0	6.0	12.5	10.0	0.6	100	1,500	100	1,500
182	0.0018	15.5	11.0	6.0	12.5	10.0	0.6	100	1,500	100	1,500	15.5	11.0	6.0	12.5	10.0	0.6	100	1,500	100	1,500	15.5	11.0	6.0	12.5	10.0	0.6	100	1,500	100	1,500
222	0.0022	15.5	11.5	6.0	12.5	10.0	0.6	100	1,500	100	1,500	15.5	11.5	6.0	12.5	10.0	0.6	100	1,500	100	1,500	15.5	11.5	6.0	12.5	10.0	0.6	100	1,500	100	1,500
272	0.0027	15.5	12.0	6.5	12.5	10.0	0.6	100	1,500	100	1,500	15.5	12.0	6.5	12.5	10.0	0.6	100	1,500	100	1,500	15.5	12.0	6.5	12.5	10.0	0.6	100	1,500	100	1,500
332	0.0033	15.5	11.5	6.0	12.5	10.0	0.6	100	1,000	100	1,000	15.5	11.5	6.0	12.5	10.0	0.6	100	1,000	100	1,000	15.5	11.5	6.0	12.5	10.0	0.6	100	1,000	100	1,000
392	0.0039	15.5	12.0	6.5	12.5	10.0	0.6	100	1,000	100	1,000	15.5	12.0	6.5	12.5	10.0	0.6	100	1,000	100	1,000	15.5	12.0	6.5	12.5	10.0	0.6	100	1,000	100	1,000
472	0.0047	15.5	12.5	7.0	12.5	10.0	0.6	100	1,000	100	1,000	15.5	12.5	7.0	12.5	10.0	0.6	100	1,000	100	1,000	15.5	12.5	7.0	12.5	10.0	0.6	100	1,000	100	1,000
562	0.0056	15.5	13.0	7.5	12.5	10.0	0.6	100	1,000	100	1,000	15.5	13.0	7.5	12.5	10.0	0.6	100	1,000	100	1,000	15.5	13.0	7.5	12.5	10.0	0.6	100	1,000	100	1,000
682	0.0068	15.5	11.0	6.0	12.5	10.0	0.6	100	1,000	100	1,000	15.5	15.0	7.5	12.5	10.0	0.6	100	1,000	100	1,000	15.5	15.0	7.5	12.5	10.0	0.6	100	1,000	100	1,000
822	0.0082	15.5	11.0	6.0	12.5	12.5	0.6	100	1,000	100	1,000	21.0	12.0	5.0	17.5	12.5	0.6	100	500	100	500	21.0	12.0	5.0	17.5	12.5	0.6	100	500	100	500
103	0.010	15.5	11.0	6.0	12.5	12.5	0.6	100	1,000	100	1,000	21.0	12.5	5.0	17.5	12.5	0.6	100	500	100	500	21.0	12.5	5.0	17.5	12.5	0.6	100	500	100	500
123	0.012	15.5	12.0	6.0	12.5	12.5	0.6	100	1,000	100	1,000	21.0	13.0	5.5	17.5	12.5	0.6	100	500	100	500	21.0	13.0	5.5	17.5	12.5	0.6	100	500	100	500
153	0.015	15.5	12.5	7.0	12.5	12.5	0.6	100	1,000	100	1,000	21.0	13.5	6.0	17.5	12.5	0.6	100	500	100	500	21.0	13.5	6.0	17.5	12.5	0.6	100	500	100	500
183	0.018	15.5	13.0	7.5	12.5	12.5	0.8	100	1,000	100	1,000	21.0	14.5	6.5	17.5	12.5	0.8	100	500	100	500	21.0	14.5	6.5	17.5	12.5	0.8	100	500	100	500
223	0.022	15.5	15.5	7.5	12.5	12.5	0.8	100	1,000	100	1,000	21.0	15.0	7.0	17.5	12.5	0.8	50	250	50	250	21.0	15.0	7.0	17.5	12.5	0.8	50	250	50	250
273	0.027	21.0	13.0	6.0	17.5	12.5	0.8	50	500	50	500	26.0	15.5	6.0	22.5	17.5	0.8	50	250	50	250	26.0	15.5	6.0	22.5	17.5	0.8	50	250	50	250
333	0.033	21.0	14.0	6.5	17.5	12.5	0.8	50	500	50	500	26.0	16.0	6.5	22.5	17.5	0.8	50	250	50	250	26.0	16.0	6.5	22.5	17.5	0.8	50	250	50	250
393	0.039	21.0	14.5	7.0	17.5	12.5	0.8	50	500	50	500	26.0	16.5	7.0	22.5	17.5	0.8	50	250	50	250	26.0	16.5	7.0	22.5	17.5	0.8	50	250	50	250
473	0.047	21.0	15.5	7.5	17.5	12.5	0.8	50	300	50	300	26.0	17.0	8.0	22.5	17.5	0.8	50	250	50	250	26.0	17.0	8.0	22.5	17.5	0.8	50	250	50	250
563	0.056	21.0	17.0	7.5	17.5	12.5	0.8	50	300	50	300	31.0	17.0	7.5	27.5	22.5	0.8	50	250	50	250	31.0	17.0	7.5	27.5	22.5	0.8	50	250	50	250
683	0.068	21.0	18.0	8.5	17.5	12.5	0.8	50	300	50	300	31.0	17.5	8.0	27.5	22.5	0.8	50	250	50	250	31.0	17.5	8.0	27.5	22.5	0.8	50	250	50	250
823	0.082	21.0	18.5	9.0	17.5	12.5	0.8	50	300	50	300	31.0	18.5	9.0	27.5	22.5	0.8	50	150	50	150	31.0	18.5	9.0	27.5	22.5	0.8	50	150	50	150
104	0.10	21.0	20.0	10.0	17.5	12.5	0.8	50	300	50	300	31.0	19.5	10.0	27.5	22.5	0.8	50	150	50	150	31.0	19.5	10.0	27.5	22.5	0.8	50	150	50	150
124	0.12	26.0	18.5	9.0	22.5	17.5	0.8	50	250	50	250	31.0	20.5	11.5	27.5	22.5	0.8	50	150	50	150	31.0	20.5	11.5	27.5	22.5	0.8	50	150	50	150
154	0.15	26.0	20.0	10.0	22.5	17.5	0.8	50	250	50	250	31.0	23.0	12.0	27.5	22.5	0.8	50	150	50	150	31.0	23.0	12.0	27.5	22.5	0.8	50	150	50	150
184	0.18	26.0	22.0	10.5	22.5	17.5	0.8	50	150	50	150	31.0	24.5	13.0	27.5	22.5	0.8	50	150	50	150	31.0	24.5	13.0	27.5	22.5	0.8	50	150	50	150
224	0.22	26.0	23.0	12.0	22.5	17.5	0.8	50	150	50	150	31.0	26.5	14.5	27.5	22.5	0.8	25	100	50	100	31.0	26.5	14.5	27.5	22.5	0.8	25	100	50	100
274	0.27	26.0	25.0	13.5	22.5	17.5	0.8	25	150	25	150																				
334	0.33	31.0	24.0	13.0	27.5	22.5	0.8	20	100	20	100																				
394	0.39	31.0	26.0	14.0	27.5	22.5	0.8	20	100	20	100																				
474	0.47	31.0	27.5	15.5	27.5	22.5	0.8	20	100	20	100																				

ご使用にあたっては、使用上の注意事項(9-16頁)をご確認の上、技術仕様書等をお求め願ひ、仕様書の範囲内でのご使用をお願いします。 When using our capacitors, please consider the application notes on pages 9-16 and contact NISSEI for any additional technical specifications relating to the limits of our performance characteristics.

周波数に対する許容電流特性 / Characteristics of permissible current to frequency

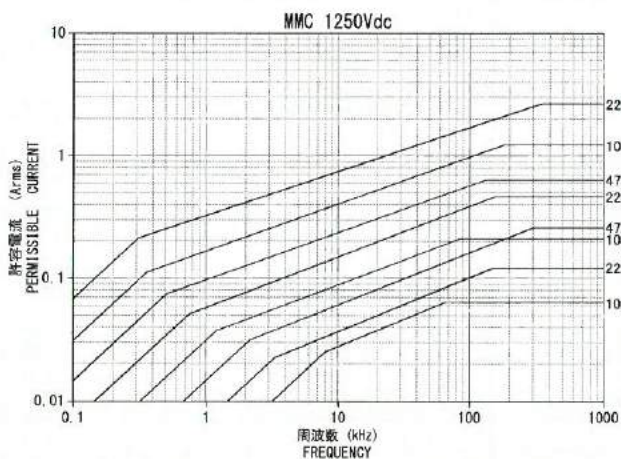
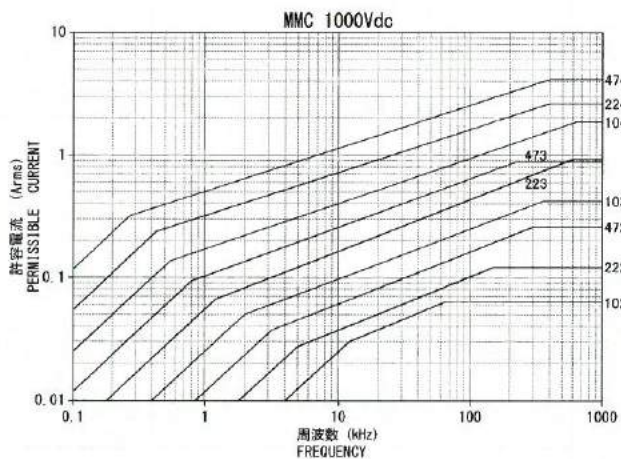
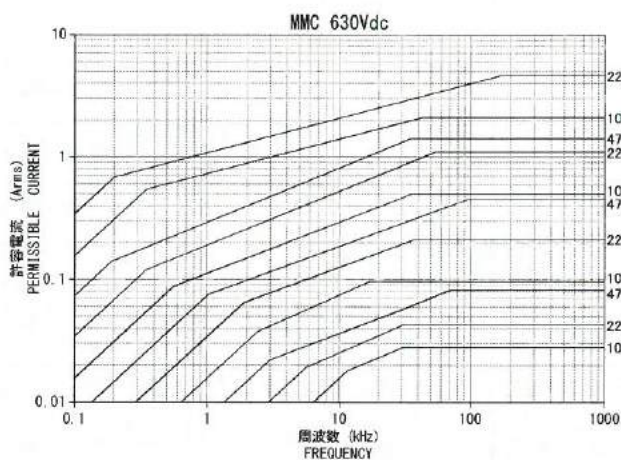
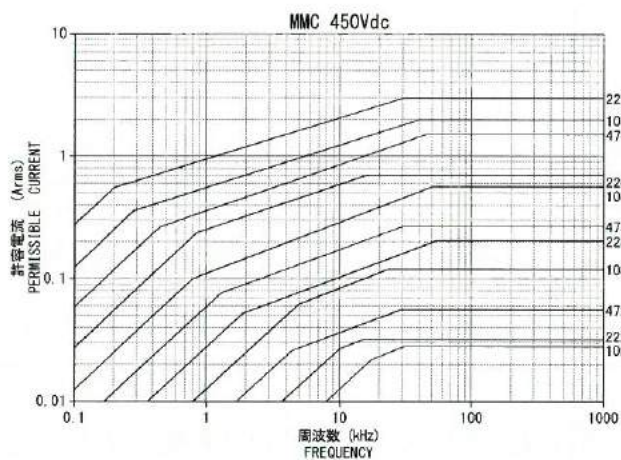
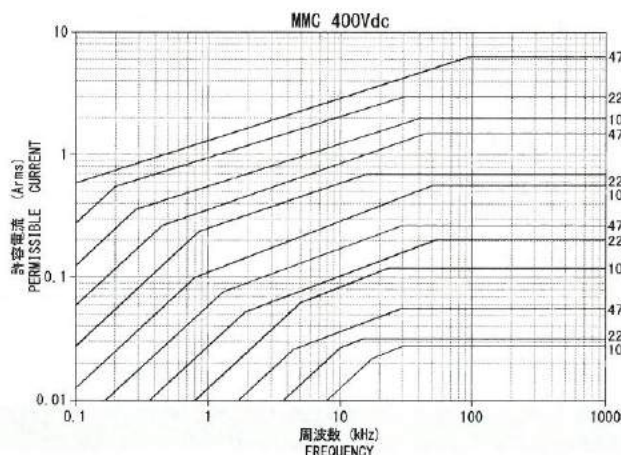
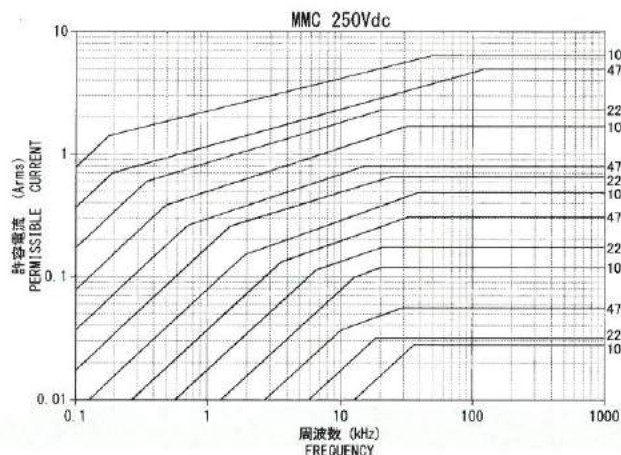

ご使用にあたっては、使用上の注意事項(9-16頁)をご確認の上、技術仕様書等をお求め願ひ、仕様書の範囲内でのご使用をお願いします。 When using our capacitors, please consider the application notes on pages 9-16 and contact NISSEI for any additional technical specifications relating to the limits of our performance characteristics.

特徴/Features

- MMBタイプを更に、小型化した製品です。
- 低インピーダンス性に優れ、高リップル電流を流せます。
- 自己回復作用があるため信頼性に優れ長寿命が期待できます。
- 高周波化されたスイッチング電源等の大電流用途に最適です。

- ★Smaller version of MMB type.
- ★Low impedance and capable of accepting high ripple currents.
- ★Self-healing performance provides high reliability and long life.
- ★Best suited for large current applications such as switching power supply.

規格/Specifications

使用温度範囲 Temp. range	-40~+105°C
定格電圧 Rated voltage	35Vdc, 63Vdc
静電容量範囲 Capacitance	4.7, 10.0, 22.0 μF
静電容量許容差 Cap. tolerance	±10% (K)
誘電正接 Tangent of loss angle	0.007 ₅₀ T ₅₀ (at 1kHz)
絶縁抵抗 Insulation resistance	3,000 Ω F ₅₀ T ₅₀
高温負荷 Endurance	105°C WV × 125% 1000Hr印加 ΔC/C ±5% ₅₀ in tan δ 0.01 ₅₀ IR 900 Ω F ₅₀ T ₅₀
耐湿負荷 Damp heat	60°C 90~95%RH, WV, 500Hr印加 ΔC/C ±5% ₅₀ in tan δ 0.01 ₅₀ IR 900 Ω F ₅₀ T ₅₀

形状 Style	ストレートリード Straight lead type		フォーミング Forming lead type		
Cap範囲 Cap range	35Vdc	475, 106, 226	F=10.0	F=12.5	F=20.0
	63Vdc	475, 106, 226	475	106	226

寸法/Dimensions (mm)

Cap CODE	Cap (μF)	MMB (A) 35Vdc										MMB (A) 63Vdc							
		NUMBER OF PIECES FOR PACKING UNIT							NUMBER OF PIECES FOR PACKING UNIT				NUMBER OF PIECES FOR PACKING UNIT						
		W	H	T	P	φd	ロング Long	フォーミング Formed	ロング Long	フォーミング Formed	ロング Long	フォーミング Formed	ロング Long	フォーミング Formed					
475	4.7	12.5	17.0	8.0	10.0	0.8	100	500	100	500	12.5	20.0	9.0	10.0	0.8	100	500	100	500
106	10.0	14.5	20.5	10.0	12.5	0.8	50	300	50	300	14.5	23.0	12.0	12.5	0.8	50	300	50	300
226	22.0	23.0	21.0	11.5	20.0	0.8	25	200	25	200	23.0	25.0	13.0	20.0	0.8	25	150	25	150

周波数に対する許容電流特性/Characteristics of permissible current to frequency

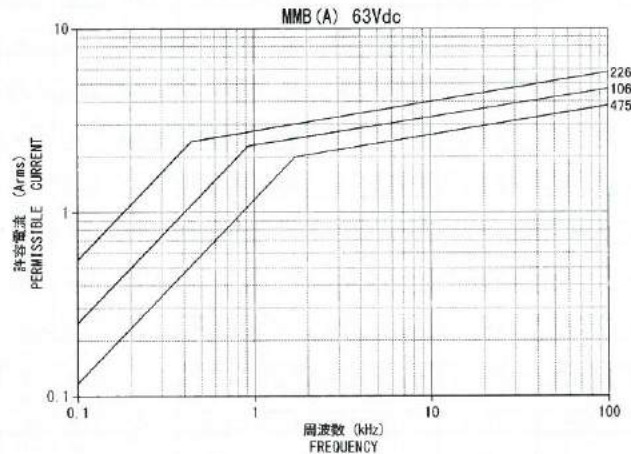
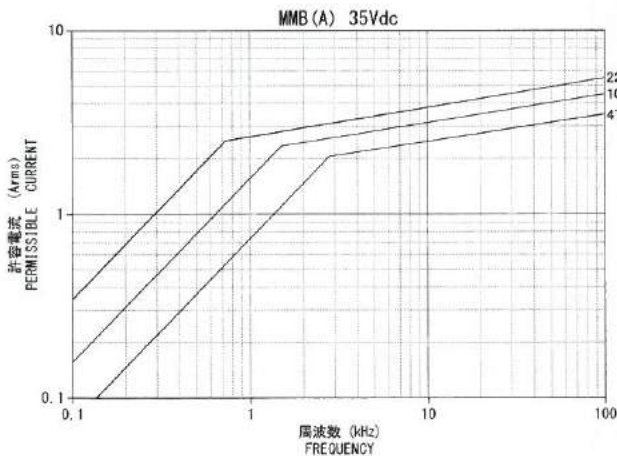

特徴/Features

- 非常に小型化されています。
- 外装に難燃性エポキシ樹脂 (UL94 V-0認定品) を使用しており、電源回路雑音防止用として最適です。

- ★Very small size.
- ★Ideal for use as interference suppression capacitors because a flame-retardant epoxy resin (UL94 V-0 recognized resin) is used as an outer coating.

規格/Specifications

使用温度範囲 Temp. range	-40~+105°C
定格電圧 Rated voltage	125Vac
静電容量範囲 Capacitance	0.010~4.7μF (E-12)
静電容量許容差 Cap. tolerance	±10% (K), ±20% (M)
誘電正接 Tangent of loss angle	0.01 _{100V} (at 1kHz)
耐電圧 Voltage proof	端子間 Between terminals 288Vac 1min.
	端子外装間 Between terminals and case 1000Vac 1min.
絶縁抵抗 Insulation resistance	C ≤ 0.47 μF 2,000MΩ _{100V} (at 500Vdc)
	C > 0.47 μF 3,000Ω F _{100V} (at 100Vdc)
高温負荷 Endurance	105°C WV × 120% Vac 1000hr印加 ΔC/C ± 7% _{100V} in tan δ 0.011 _{100V}
	IR C ≤ 0.47 μF 1,000Ω F _{100V} C > 0.47 μF 1,500Ω F _{100V}
耐湿負荷 Damp heat	40°C 90~95%RH WV × √2 1000hr印加 ΔC/C ± 10% _{100V} in tan δ 0.011 _{100V}
	IR C ≤ 0.47 μF 1,000Ω F _{100V} C > 0.47 μF 1,500Ω F _{100V}

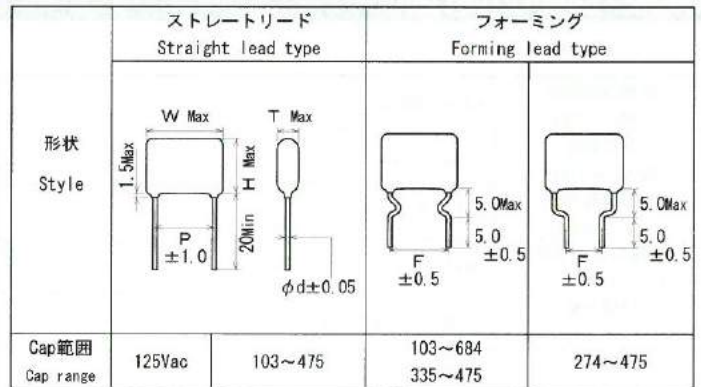

詳細は37頁をご参照下さい。

Please refer to page 37 for more information.

テーピング仕様のリードピッチ寸法(F)は、6~7頁のテーピング寸法表をご参照下さい。
For a pitch space (F) of the taping specification, refer to "TAPING DIMENSIONS" on pages 6 to 7.

寸法/Dimensions (mm)

Cap CODE	Cap (μF)	MML 125Vac							基準収納数 NUMBER OF PIECES FOR PACKING UNIT			
		W	H	T	P	F	φd	テーピング Taping	ロング Long	フォーミング Formed		
103	0.010	9.8	5.6	4.2	7.5	5.0/7.5	0.6	Ammo	Bag	Box	Bag	Box
123	0.012	9.8	5.5	4.2	7.5	5.0/7.5	0.6	1,000	200	2,000	200	3,000
153	0.015	9.8	5.6	4.2	7.5	5.0/7.5	0.6	1,000	200	2,000	200	3,000
183	0.018	9.8	5.9	4.2	7.5	5.0/7.5	0.6	1,000	200	2,000	200	3,000
223	0.022	9.8	5.9	4.2	7.5	5.0/7.5	0.6	1,000	200	2,000	200	3,000
273	0.027	9.8	5.9	4.2	7.5	5.0/7.5	0.6	1,000	200	2,000	200	3,000
333	0.033	9.8	6.0	4.2	7.5	5.0/7.5	0.6	1,000	200	2,000	200	3,000
393	0.039	9.8	6.0	4.2	7.5	5.0/7.5	0.6	1,000	200	2,000	200	3,000
473	0.047	9.8	6.2	4.3	7.5	5.0/7.5	0.6	1,000	200	2,000	200	3,000
563	0.056	9.8	6.4	4.5	7.5	5.0/7.5	0.6	1,000	200	2,000	200	3,000
683	0.068	9.8	6.7	4.8	7.5	5.0/7.5	0.6	1,000	200	2,000	200	3,000
823	0.082	9.8	7.7	4.1	7.5	5.0/7.5	0.6	1,000	200	2,000	200	3,000
104	0.10	9.8	7.7	4.3	7.5	5.0/7.5	0.6	1,000	200	2,000	200	3,000
124	0.12	9.8	7.7	5.0	7.5	5.0/7.5	0.6	1,000	200	2,000	200	3,000
154	0.15	9.8	8.6	5.5	7.5	5.0/7.5	0.6	1,000	100	1,500	100	1,500
184	0.18	9.8	11.2	5.0	7.5	5.0/7.5	0.6	1,000	100	1,500	100	1,500
224	0.22	9.8	11.8	5.5	7.5	5.0/7.5	0.6	1,000	100	1,500	100	1,500
274	0.27	12.5	11.3	5.0	10.0	5.0/7.5/10.0	0.6	1,000	100	1,000	100	1,000
334	0.33	12.5	10.8	6.0	10.0	5.0/7.5/10.0	0.6	1,000	100	1,000	100	1,000
394	0.39	12.5	11.2	6.5	10.0	5.0/7.5/10.0	0.6	500	100	1,000	100	1,000
474	0.47	12.5	11.7	7.0	10.0	5.0/7.5/10.0	0.6	500	100	1,000	100	1,000
564	0.56	12.5	13.3	7.0	10.0	5.0/7.5/10.0	0.6	500	100	500	100	500
684	0.68	12.5	14.0	7.7	10.0	5.0/7.5/10.0	0.6	500	100	500	100	500
824	0.82	17.8	12.8	5.6	15.0	5.0/7.5/10.0	0.8	500	100	500	100	500
105	1.0	17.8	13.4	6.2	15.0	5.0/7.5/10.0	0.8	400	100	500	100	500
125	1.2	17.8	14.5	7.3	15.0	5.0/7.5/10.0	0.8	400	50	500	50	500
155	1.5	17.8	15.5	8.5	15.0	5.0/7.5/10.0	0.8	300	50	400	50	500
165	1.8	17.8	16.5	9.3	15.0	5.0/7.5/10.0	0.8	300	50	250	50	250
225	2.2	17.8	17.5	10.3	15.0	5.0/7.5/10.0	0.8	200	50	250	50	250
275	2.7	17.8	18.5	11.5	15.0	5.0/7.5/10.0	0.8	200	50	200	50	200
335	3.3	25.5	18.5	9.3	22.5	15.0/22.5	0.8		50	200	50	200
395	3.9	25.5	19.5	10.3	22.5	15.0/22.5	0.8		50	200	50	200
475	4.7	25.5	20.7	11.3	22.5	15.0/22.5	0.8		50	200	50	200

ご使用にあたっては、使用上の注意事項(9-16頁)をご確認の上、技術仕様書等をお求め願ひ、仕様書の範囲内でのご使用をお願いします。 When using our capacitors, please consider the application notes on pages 9-16 and contact NISSEI for any additional technical specifications relating to the limits of our performance characteristics.

特徴/Features

- 外装に難燃性エポキシ樹脂 (UL94 V-0認定品) を使用しており、電源回路雑音防止用として最適です。
- 高信頼性

- ★Ideal for use as interference suppression capacitors because a flame-retardant epoxy resin (UL94 V-0 recognized resin) is used as an outer coating.
- ★High reliability

規格/Specifications

使用温度範囲 Temp. range	-40~+105°C		
定格電圧 Rated voltage	125Vac, 250Vac		
静電容量範囲 Capacitance	125Vac	0.010~1.0μF (E-12)	
	250Vac	0.010~0.47μF (E-12)	
静電容量許容差 Cap. tolerance	125Vac	±5%(J) ±10%(K), ±20%(M)	
	250Vac	±10%(K), ±20%(M)	
誘電正接 Tangent of loss angle	0.008 ₁₀₀₀ (at 1kHz)		
耐電圧 Voltage proof	端子間 Between terminals	125Vac	288V.ac 1min.
	端子外装間 Between terminals and case	250Vac	575V.ac 1min.
絶縁抵抗 Insulation resistance	2,000MΩ _{500Vdc} (at 500Vdc)		
	高温負荷 Endurance	105°C WV×120% Vac 1000hr印加 ΔC/C ±7% ₁₀₀₀ tanδ 0.01 ₁₀₀₀ IR 1,000MΩ _{500Vdc}	
耐湿負荷 Damp heat	40°C 90~95%RH WV×√2 500hr印加 ΔC/C ±10% ₁₀₀₀ tanδ 0.01 ₁₀₀₀ IR 1,000MΩ _{500Vdc}		

形状 Style	ストレートリード Straight lead type		フォーミング Forming lead type	
Cap範囲 Cap range	125Vac	103~105	103~224	823~105
	250Vac	103~474	103~473	103~474

詳細は37頁をご参照下さい。

Please refer to page 37 for more information.

テーピング仕様のリードピッチ寸法(F)は、6~7頁のテーピング寸法表をご参照下さい。

For a pitch space (F) of the taping specification, refer to "TAPING DIMENSIONS" on pages 6 to 7.

寸法/Dimensions (mm)

Cap CODE	Cap (μF)	MMD 125Vac										MMD 250Vac											
		基準収納数 NUMBER OF PIECES FOR PACKING UNIT								テーピング Taping		ロング Long		フォーミング Formed		基準収納数 NUMBER OF PIECES FOR PACKING UNIT							
		W	H	T	P	F	φd	Ammo	Bag	Box	Bag	Box	W	H	T	P	F	φd	Ammo	Bag	Box	Bag	Box
103	0.010	11.0	8.2	5.0	7.5	5.0/7.5	0.6	1,000	200	2,000	200	4,000	13.0	10.0	5.5	10.0	5.0/7.5/10.0	0.6	1,000	100	1,500	100	1,500
123	0.012	11.0	8.2	5.0	7.5	5.0/7.5	0.6	1,000	200	2,000	200	4,000	13.0	10.5	6.0	10.0	5.0/7.5/10.0	0.6	1,000	100	1,500	100	1,500
153	0.015	11.0	8.2	5.0	7.5	5.0/7.5	0.6	1,000	200	2,000	200	4,000	13.0	10.5	6.0	10.0	5.0/7.5/10.0	0.6	1,000	100	1,500	100	1,500
183	0.018	11.0	8.2	5.0	7.5	5.0/7.5	0.6	1,000	200	2,000	200	4,000	13.0	10.5	6.0	10.0	5.0/7.5/10.0	0.6	1,000	100	1,500	100	1,500
223	0.022	11.0	8.2	5.0	7.5	5.0/7.5	0.6	1,000	200	2,000	200	4,000	13.0	10.8	6.0	10.0	5.0/7.5/10.0	0.6	1,000	100	1,500	100	1,500
273	0.027	11.0	8.2	5.0	7.5	5.0/7.5	0.6	1,000	200	2,000	200	4,000	13.0	10.8	6.0	10.0	5.0/7.5/10.0	0.6	1,000	100	1,500	100	1,500
333	0.033	11.0	8.2	5.0	7.5	5.0/7.5	0.6	1,000	200	2,000	200	4,000	13.0	11.3	6.3	10.0	5.0/7.5/10.0	0.6	500	100	1,000	100	1,000
393	0.039	11.0	8.2	5.0	7.5	5.0/7.5	0.6	1,000	200	2,000	200	4,000	13.0	12.8	6.3	10.0	5.0/7.5/10.0	0.6	500	100	1,000	100	1,000
473	0.047	11.0	8.2	5.5	7.5	5.0/7.5	0.6	1,000	200	2,000	200	4,000	13.0	14.5	6.3	10.0	5.0/7.5/10.0	0.6	500	100	1,000	100	1,000
563	0.056	11.0	8.7	6.0	7.5	5.0/7.5	0.6	1,000	200	2,000	200	3,000	18.5	10.8	6.0	15.0	5.0/7.5/10.0	0.6	500	100	1,000	100	1,000
683	0.068	11.0	9.2	6.0	7.5	5.0/7.5	0.6	1,000	200	2,000	200	3,000	18.5	11.3	6.3	15.0	5.0/7.5/10.0	0.6	400	100	1,000	100	1,000
823	0.082	14.0	9.2	5.5	10.0	5.0/7.5/10.0	0.6	1,000	100	1,500	200	2,000	18.5	11.5	6.5	15.0	5.0/7.5/10.0	0.6	400	100	1,000	100	1,000
104	0.10	14.0	10.5	5.5	10.0	5.0/7.5/10.0	0.6	1,000	100	1,500	200	2,000	18.5	13.3	6.5	15.0	5.0/7.5/10.0	0.6	400	50	500	50	500
124	0.12	14.0	11.0	6.0	10.0	5.0/7.5/10.0	0.6	1,000	100	1,500	200	2,000	18.5	13.8	7.0	15.0	5.0/7.5/10.0	0.6	400	50	500	50	500
154	0.15	14.0	11.5	6.0	10.0	5.0/7.5/10.0	0.6	1,000	100	1,500	200	2,000	18.5	14.5	7.8	15.0	5.0/7.5/10.0	0.8	300	50	500	50	500
184	0.18	14.0	12.0	6.5	10.0	5.0/7.5/10.0	0.6	1,000	100	1,500	100	1,500	18.5	15.3	8.5	15.0	5.0/7.5/10.0	0.8	300	50	500	50	500
224	0.22	14.0	12.5	7.3	10.0	5.0/7.5/10.0	0.6	1,000	100	1,000	100	1,500	18.5	16.0	9.5	15.0	5.0/7.5/10.0	0.8	300	50	500	50	500
274	0.27	19.0	11.5	6.0	15.0	5.0/7.5/10.0	0.6	500	100	1,000	100	1,500	26.0	17.0	7.0	22.5	15.0	0.8		50	250	50	250
334	0.33	19.0	13.0	6.0	15.0	5.0/7.5/10.0	0.6	500	100	1,000	100	1,000	26.0	16.5	8.0	22.5	15.0	0.8		50	250	50	250
394	0.39	19.0	13.5	6.5	15.0	5.0/7.5/10.0	0.6	400	100	1,000	100	1,000	26.0	17.3	8.8	22.5	15.0	0.8		50	250	50	250
474	0.47	19.0	14.0	7.0	15.0	5.0/7.5/10.0	0.6	400	50	500	50	500	26.0	18.0	9.5	22.5	15.0	0.8		50	250	50	250
564	0.56	19.0	16.0	7.0	15.0	5.0/7.5/10.0	0.6		50	500	50	500											
684	0.68	19.0	16.5	8.0	15.0	5.0/7.5/10.0	0.8		50	500	50	500											
824	0.82	25.5	16.0	7.0	22.5	15.0	0.8		50	250	50	300											
105	1.0	25.5	16.5	7.5	22.5	15.0	0.8		50	250	50	300											

形状 Style	フォーミング Forming lead type									
	Type	WV	F=5.0	F=7.5	F=10.0	F=22.5	F=5.0	F=7.5	F=10.0	F=15.0
Cap範囲 Cap range	MML	125Vac	103~224	103~684	274~684	335~475	274~275	824~275	824~275	335~475
	MMD	125Vac	103~683	103~224	823~224		823~684	274~684	274~684	824~105
		250Vac		103~473	103~473		103~224	563~224	563~224	224~474

テーピング仕様のリードピッチ寸法(F)は、6~7頁のテーピング寸法表をご参照下さい。
For a pitch space (F) of the taping specification, refer to "TAPING DIMENSIONS" on pages 6 to 7.

周波数に対する許容電流特性 / Characteristics of permissible current to frequency

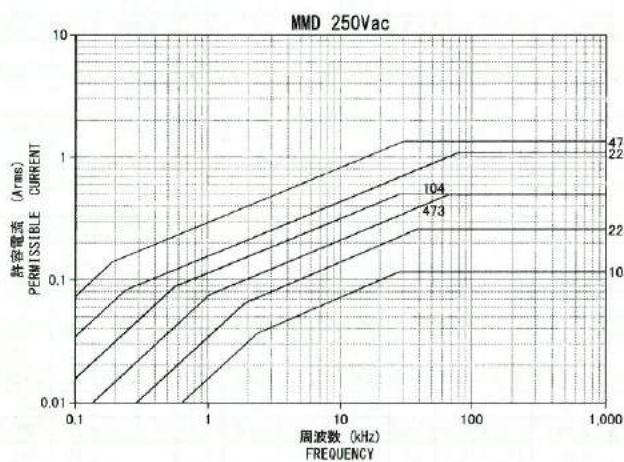
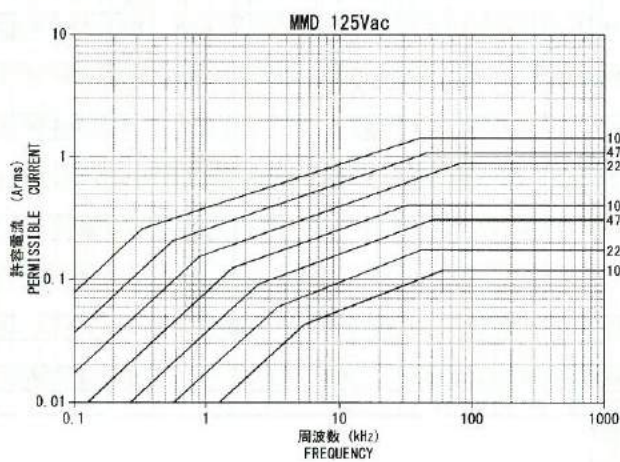
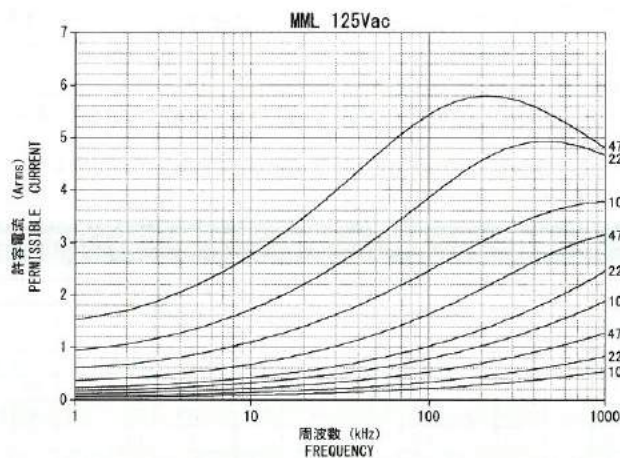

使用上の注意 / Caution

- 使用上の注意) アクロス・ザ・ライン用として下記の条件でご使用下さい。
- 定格電圧125V品はコンデンサと並列にバリスタ電圧が250V以下のバリスタが入っていること、またはコンデンサの両端に250V以上のパルス電圧付加されないこと。
 - 定格電圧250V品はコンデンサと並列にバリスタ電圧が470V以下のバリスタが入っていること、またはコンデンサの両端に630V以上のパルス電圧付加されないこと。

- ★When using these capacitors as an across-the-line capacitor, it shall be required to follow to either item1 or item2 condition.
- Capacitors shall be connected in parallel with varistor. (below 250V for 125Vac and 470V for 250Vac)
 - Voltage applied for capacitor shall not exceed 250Vo-p for 125Vac and 630Vo-p for 250Vac.

ご使用にあたっては、使用上の注意事項(9-16頁)をご確認の上、技術仕様書等をお求め願ひ、仕様書の範囲内でのご使用をお願い致します。 When using our capacitors, please consider the application notes on pages 9-16 and contact NISSEI for any additional technical specifications relating to the limits of our performance characteristics.

特徴/Features

- 低損失であり、高周波大電流回路に最適です。
- 周波数特性、温度特性に優れています。
- 各種スイッチング電源用。
- 照明インバーター用

- ★With a low dissipation factor, best suited to high frequency, large current circuits.
- ★Excellent frequency and temperature characteristics.
- ★Various SMPS
- ★Lighting inverters

規格/Specifications

使用温度範囲 Temp. range	-40~+105°C
定格電圧 Rated voltage	250V, 400V, 450V, 630V, 800V, 1000V, 1250V, 1600Vdc
静電容量範囲 Capacitance	250Vdc 0.010~10 μ F (E-24) 400V, 450Vdc 0.010~3.3 μ F (E-24) 630Vdc 0.010~2.2 μ F (E-24) 800Vdc 0.0010~0.68 μ F (E-24) 1000Vdc 0.0010~0.22 μ F (E-24) 1250Vdc 0.0010~0.18 μ F (E-24) 1600Vdc 0.0010~0.10 μ F (E-24)
静電容量許容差 Cap. tolerance	$\pm 3\%$ (H), $\pm 5\%$ (J) $\pm 2\%$ (G) は1250, 1600V 0.001~0.01 μ Fのみ Tol "G" is applied to 1250, 1600V only(0.001~0.01 μ F) $\pm 10\%$ (K) は250, 400, 450, 630Vのみ Tol "K" is applied to 250, 400, 450, 630V only
誘電正接 Tangent of loss angle	0.0005 $_{\text{at } 1\text{kHz}}$
耐電圧 Voltage Proof	WV $\times 150\%$ 60sec or WV $\times 175\%$ 1~5 sec
絶縁抵抗 Insulation resistance	C $\leq 0.33\mu$ F 30,000M Ω $_{\text{at } 100\text{Vdc}/1\text{min}}$ C $> 0.33\mu$ F 10,000 Ω $_{\text{at } 100\text{Vdc}/1\text{min}}$
高温負荷 Endurance	105°C WV $\times 125\%$ 1000hr印加 $\Delta C/C \pm 5\%$ $_{\text{at } 1000\text{hr}}$ $\tan \delta 0.0008$ $_{\text{at } 1000\text{hr}}$ C $\leq 0.33\mu$ F 15,000M Ω $_{\text{at } 1000\text{hr}}$ C $> 0.33\mu$ F 5,000 Ω $_{\text{at } 1000\text{hr}}$
耐湿負荷 Damp heat	85°C 85%RH WV 500hr印加 $\Delta C/C \pm 7\%$ $_{\text{at } 500\text{hr}}$ $\tan \delta 0.0008$ $_{\text{at } 500\text{hr}}$ C $\leq 0.33\mu$ F 5,000M Ω $_{\text{at } 500\text{hr}}$ C $> 0.33\mu$ F 1,500 Ω $_{\text{at } 500\text{hr}}$

寸法/Dimensions (mm)

Cap CODE	Cap (μ F)	MPE 250Vdc										基本包装数 NUMBER OF PIECES FOR PACKING UNIT			
		W	H	T	P	F	ϕd	テーピング Taping	ロング Long	フォーミング Formed	テーピング Taping	ロング Long	フォーミング Formed	テーピング Taping	
103	0.010	13.0	9.0	5.5	10.0	7.5/10.0	0.6	1,000	200	1,600	200	1,600			
123	0.012	13.0	9.0	5.5	10.0	7.5/10.0	0.6	1,000	200	1,600	200	1,600			
153	0.015	13.0	9.5	6.0	10.0	7.5/10.0	0.6	1,000	200	1,000	200	1,000			
183	0.018	13.0	10.0	6.0	10.0	7.5/10.0	0.6	1,000	200	1,000	200	1,000			
223	0.022	13.0	10.5	6.5	10.0	7.5/10.0	0.6	1,000	200	1,000	200	1,000			
273	0.027	13.0	10.5	7.0	12.0	7.5/10.0	0.6	1,000	200	1,000	200	1,000			
333	0.033	13.0	9.0	5.5	10.0	7.5/10.0	0.6	1,000	200	1,000	200	1,000			
393	0.039	13.0	9.5	6.0	10.0	7.5/10.0	0.6	1,000	200	1,000	200	1,000			
473	0.047	13.0	10.0	6.0	10.0	7.5/10.0	0.6	1,000	200	1,000	200	1,000			
563	0.056	13.0	10.0	6.5	10.0	7.5/10.0	0.6	1,000	200	1,000	200	1,000			
683	0.068	13.0	10.5	7.0	10.0	7.5/10.0	0.6	1,000	200	1,000	200	1,000			
823	0.082	13.0	11.0	7.5	10.0	7.5/10.0	0.6	500	200	1,000	200	1,000			
104	0.10	15.5	12.0	6.5	12.5	7.5/10.0	0.6	400	200	1,000	200	1,000			
124	0.12	15.5	12.5	7.0	12.5	7.5/10.0	0.6	400	100	500	100	500			
154	0.15	15.5	13.0	7.5	12.5	7.5/10.0	0.6	400	100	500	100	500			
184	0.18	15.5	13.5	8.0	12.5	7.5/10.0	0.6	500	100	500	100	500			
224	0.22	15.5	12.0	6.5	12.5	7.5/10.0	0.6	400	100	500	100	500			
274	0.27	15.5	12.5	7.0	12.5	7.5/10.0	0.6	400	100	500	100	500			
334	0.33	15.5	13.0	7.5	12.5	7.5/10.0	0.6	400	100	500	100	500			
394	0.39	15.5	12.5	7.0	12.5	7.5/10.0	0.6	300	100	500	100	500			
474	0.47	20.5	13.5	7.0	17.5	7.5/10.0/12.5	0.8	400	100	500	100	500			
564	0.56	20.5	14.0	7.5	17.5	7.5/10.0/12.5	0.8	400	50	300	50	300			
684	0.68	20.5	14.5	8.0	17.5	7.5/10.0/12.5	0.8	300	50	300	50	300			
824	0.82	20.5	15.0	8.5	17.5	7.5/10.0/12.5	0.8	300	50	300	50	300			
105	1.0	20.5	16.0	9.5	17.5	7.5/10.0/12.5	0.8	300	50	300	50	300			
125	1.2	20.5	17.0	10.0	17.5	7.5/10.0/12.5	0.8		50	200	50	200			
155	1.5	20.5	18.0	11.0	17.5	7.5/10.0/12.5	0.8		50	200	50	200			
185	1.8	25.5	19.5	9.5	22.5	17.5	0.8		50	200	50	200			
225	2.2	25.5	20.5	10.5	22.5	17.5	0.8		50	200	50	200			
275	2.7	25.5	21.5	11.5	22.5	17.5	0.8		20	100	20	100			
335	3.3	25.5	22.5	12.5	22.5	17.5	0.8		20	100	20	100			
395	3.9	31.0	22.5	13.0	27.5	22.5	0.8		20	100	20	100			
475	4.7	31.0	24.0	14.0	27.5	22.5	0.8		20	100	20	100			
565	5.6	31.0	25.0	15.0	27.5	22.5	0.8		20	100	20	100			
685	6.8	31.0	26.0	15.5	27.5	22.5	0.8		20	100	20	100			
825	8.2	37.0	25.5	17.0	32.5	27.5	0.8		10	50	10	50			
106	10.0	37.0	26.5	20.0	32.5	27.5	0.8		10	50	10	50			

形状 Style	ストレートリード Straight lead type		フォーミング Forming lead type	
	W Max	T Max	H Max	ϕd
	1.5 Max	2.0 Min	2.0 Min	± 0.05
	$P \pm 1.0$			
			5.0 Max	5.0 ± 0.5
			5.0 ± 0.5	5.0 ± 0.5
			F ± 0.5	F ± 0.5
Cap範囲 Cap range	250Vdc	103~106	F=7.5 103~913	104~165
			F=10.0 103~434	474~165
			F=12.5 474~165	474~165
			F=17.5 185~335	
			F=22.5 365~685	
			F=27.5 755~106	

テーピング仕様のリードピッチ寸法(F)は、6~7頁のテーピング寸法表をご参照下さい。
For a pitch space (F) of the taping specification, refer to "TAPING DIMENSIONS" on pages 6 to 7.

周波数に対する許容電流特性/

Characteristics of permissible current to frequency

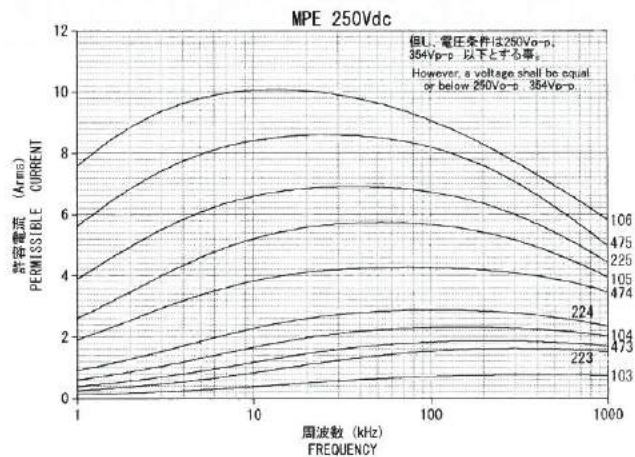

形状 Style	ストレートリード Straight lead type		フォーミング Forming lead type								
	W Max H Max T Max P ±1.0 20 Min φd±0.05	1.5Max	F=7.5 F=10.0 F=12.5				F=7.5 F=10.0 F=12.5 F=17.5 F=22.5 F=27.5				
Cap 範囲	400V/450Vdc	103~335	103~913	103~164	184~434	104~754	184~754	474~754	824~165	185~225	245~335
Cap range	630Vdc	103~225	103~303	103~753	823~154	333~274	823~274	164~274	304~754	824~125	135~225

テーピング仕様のリードピッチ寸法(F)は、6~7頁のテーピング寸法表をご参照下さい。
For a pitch space (F) of the taping specification, refer to "TAPING DIMENSIONS" on pages 6 to 7.

寸法/Dimensions (mm)

Cap CODE	Cap (μF)	MPE 400/450Vdc										MPE 630Vdc											
		W	H	T	P	F	φd	テーピング Taping		ロング Long		フォーミング Formed		W	H	T	P	F	φd	テーピング Taping		ロング Long	
103	0.010	13.0	9.0	5.5	10.0	7.5/10.0	0.6	1,000	200	1,600	200	1,600	13.0	9.0	5.5	10.0	7.5/10.0	0.6	1,000	200	1,600	200	1,600
123	0.012	13.0	9.0	5.5	10.0	7.5/10.0	0.6	1,000	200	1,600	200	1,600	13.0	9.0	5.5	10.0	7.5/10.0	0.6	1,000	200	1,600	200	1,600
153	0.015	13.0	9.5	6.0	10.0	7.5/10.0	0.6	1,000	200	1,000	200	1,000	13.0	9.5	6.0	10.0	7.5/10.0	0.6	1,000	200	1,000	200	1,000
183	0.018	13.0	10.0	6.0	10.0	7.5/10.0	0.6	1,000	200	1,000	200	1,000	13.0	10.0	6.0	10.0	7.5/10.0	0.6	1,000	200	1,000	200	1,000
223	0.022	13.0	10.5	6.5	10.0	7.5/10.0	0.6	1,000	200	1,000	200	1,000	13.0	10.5	6.5	10.0	7.5/10.0	0.6	1,000	200	1,000	200	1,000
273	0.027	13.0	10.5	7.0	10.0	7.5/10.0	0.6	1,000	200	1,000	200	1,000	13.0	10.5	7.0	10.0	7.5/10.0	0.6	1,000	200	1,000	200	1,000
333	0.033	13.0	9.0	5.5	10.0	7.5/10.0	0.6	1,000	200	1,000	200	1,000	15.5	11.5	6.5	12.5	7.5/10.0	0.6	400	200	1,000	200	1,000
393	0.039	13.0	9.5	6.0	10.0	7.5/10.0	0.6	1,000	200	1,000	200	1,000	15.5	12.0	6.5	12.5	7.5/10.0	0.6	400	200	1,000	200	1,000
473	0.047	13.0	10.0	6.0	10.0	7.5/10.0	0.6	1,000	200	1,000	200	1,000	15.5	12.5	7.0	12.5	7.5/10.0	0.6	400	200	1,000	200	1,000
593	0.056	13.0	10.0	6.5	10.0	7.5/10.0	0.6	1,000	200	1,000	200	1,000	15.5	13.0	7.5	12.5	7.5/10.0	0.6	400	100	500	100	500
683	0.068	13.0	10.5	7.0	10.0	7.5/10.0	0.6	1,000	200	1,000	200	1,000	15.5	12.5	9.0	12.5	7.5/10.0	0.6	300	100	500	100	500
823	0.082	13.0	11.0	7.5	10.0	7.5/10.0	0.6	500	200	1,000	200	1,000	18.5	14.0	7.0	15.0	7.5/10.0/12.5	0.8	400	100	500	100	500
104	0.10	15.5	12.0	6.5	12.5	7.5/10.0	0.6	400	200	1,000	200	1,000	18.5	14.5	8.0	15.0	7.5/10.0/12.5	0.8	300	100	500	100	500
124	0.12	15.5	12.5	7.0	12.5	7.5/10.0	0.6	400	100	500	100	500	18.5	15.0	8.5	15.0	7.5/10.0/12.5	0.8	300	50	300	50	300
154	0.15	15.5	13.0	7.5	12.5	7.5/10.0	0.6	400	100	500	100	500	18.5	16.0	9.5	15.0	7.5/10.0/12.5	0.8	300	50	300	50	300
184	0.18	18.5	13.5	7.0	15.0	7.5/10.0/12.5	0.8	400	100	500	100	500	20.5	16.0	9.5	17.5	7.5/10.0/12.5	0.8	300	50	300	50	300
224	0.22	18.5	14.0	7.5	15.0	7.5/10.0/12.5	0.8	400	100	500	100	500	20.5	17.0	10.0	17.5	7.5/10.0/12.5	0.8		50	300	50	300
274	0.27	18.5	15.0	8.0	15.0	7.5/10.0/12.5	0.8	300	50	400	50	400	20.5	18.0	11.0	17.5	7.5/10.0/12.5	0.8		25	200	25	200
334	0.33	18.5	15.5	9.0	15.0	7.5/10.0/12.5	0.8	300	50	400	50	400	25.5	18.5	10.0	22.5	17.5	0.8		25	200	25	200
394	0.39	18.5	15.5	10.0	15.0	7.5/10.0/12.5	0.8		50	400	50	400	25.5	19.0	10.5	22.5	17.5	0.8		25	200	25	200
474	0.47	20.5	16.5	9.5	17.5	7.5/10.0/12.5	0.8		50	300	50	400	25.5	20.0	11.5	22.5	17.5	0.8		25	200	25	200
564	0.56	20.5	17.0	10.5	17.5	7.5/10.0/12.5	0.8		25	200	25	200	25.5	21.0	13.0	22.5	17.5	0.8		20	100	20	100
684	0.68	20.5	17.5	12.0	17.5	7.5/10.0/12.5	0.8		25	200	25	200	25.5	22.5	14.0	22.5	17.5	0.8		20	100	20	100
824	0.82	25.5	18.5	10.0	22.5	17.5	0.8		25	200	25	200	31.0	23.5	13.5	27.5	22.5	0.8		20	100	20	100
105	1.0	25.5	19.5	11.0	22.5	17.5	0.8		25	200	25	200	31.0	25.0	15.0	27.5	22.5	0.8		20	100	20	100
125	1.2	25.5	20.5	12.0	22.5	17.5	0.8		20	100	20	100	31.0	26.0	16.5	27.5	22.5	0.8		20	100	20	100
155	1.5	25.5	22.0	13.5	22.5	17.5	0.8		20	100	20	100	37.0	25.5	17.0	32.5	27.5	0.8		10	50	10	50
185	1.8	31.0	23.0	13.0	27.5	22.5	0.8		20	100	20	100	37.0	26.0	19.5	32.5	27.5	0.8		10	50	10	50
225	2.2	31.0	24.5	14.5	27.5	22.5	0.8		20	100	20	100	37.0	28.0	21.0	32.5	27.5	0.8		10	50	10	50
275	2.7	37.0	24.0	14.0	32.5	27.5	0.8		10	50	10	50											
335	3.3	37.0	25.0	16.5	32.5	27.5	0.8		10	50	10	50											

周波数に対する許容電流特性/Characteristics of permissible current to frequency

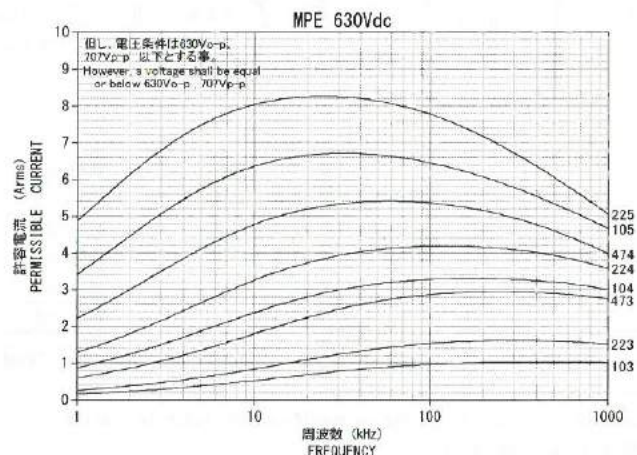
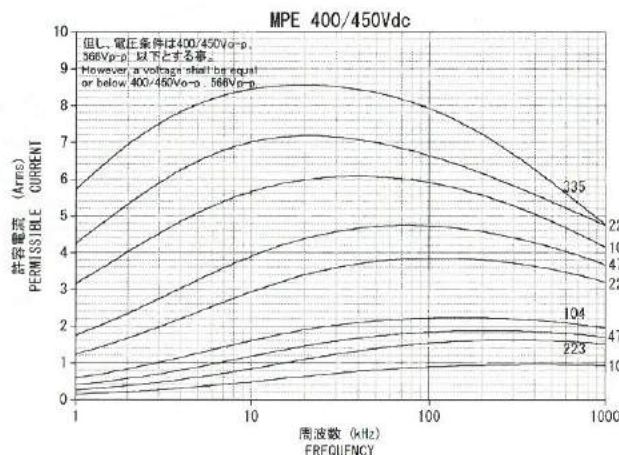

ご使用にあたっては、使用上の注意事項(9-16頁)をご確認の上、技術仕様書等をお求め願ひ、仕様書の範囲内でのご使用をお願いします。 When using our capacitors, please consider the application notes on pages 9-16 and contact NISSEI for any additional technical specifications relating to the limits of our performance characteristics.

形状 Style	ストレートリード Straight lead type		フォーミング Forming lead type				
	W Max H Max T Max P ±1.0 I Max 20 Min φd ±0.05		F ±0.5	F ±0.5	F ±0.5	F ±0.5	F ±0.5
			F=15.0	F=20.0	F=25.0	F=7.5	F=15.0
Cap 範囲 Cap range	800Vdc 1000Vdc	102~684 102~224	102~303 102~303	333~104 333~104	114~684 114~224	102~303 102~303	333~684 333~224

テーピング仕様のリードピッチ寸法(F)は、6~7頁のテーピング寸法表をご参照下さい。

For a pitch space (F) of the taping specification, refer to "TAPING DIMENSIONS" on pages 6 to 7.

寸法/Dimensions (mm)

Cap CODE	Cap (μF)	MPE 800Vdc																	MPE 1000Vdc																
		W	H	T	P	F	φd	テーピング Taping			ロング Long			フォーミング Formed			W	H	T	P	F	φd	テーピング Taping			ロング Long			フォーミング Formed						
102	0.0010	18.5	9.0	5.5	15.0	7.5/15.0	0.6	500	100	500	100	500	18.5	9.0	5.5	15.0	7.5/15.0	0.6	500	100	500	100	500	18.5	9.0	5.5	15.0	7.5/15.0	0.6	500	100	500	100	500	
122	0.0012	18.5	9.5	6.0	15.0	7.5/15.0	0.6	500	100	500	100	500	18.5	9.5	6.0	15.0	7.5/15.0	0.6	500	100	500	100	500	18.5	9.5	6.0	15.0	7.5/15.0	0.6	500	100	500	100	500	
152	0.0015	18.5	10.0	6.5	15.0	7.5/15.0	0.6	400	100	500	100	500	18.5	10.0	6.5	15.0	7.5/15.0	0.6	400	100	500	100	500	18.5	10.0	6.5	15.0	7.5/15.0	0.6	400	100	500	100	500	
182	0.0018	18.5	10.5	7.0	15.0	7.5/15.0	0.6	400	100	500	100	500	18.5	10.5	7.0	15.0	7.5/15.0	0.6	400	100	500	100	500	18.5	10.5	7.0	15.0	7.5/15.0	0.6	400	100	500	100	500	
222	0.0022	18.5	11.0	7.5	15.0	7.5/15.0	0.6	400	100	500	100	500	18.5	11.0	7.5	15.0	7.5/15.0	0.6	400	100	500	100	500	18.5	11.0	7.5	15.0	7.5/15.0	0.6	400	100	500	100	500	
272	0.0027	18.5	9.0	6.5	15.0	7.5/15.0	0.6	500	100	500	100	500	18.5	9.0	6.5	15.0	7.5/15.0	0.6	500	100	500	100	500	18.5	9.0	6.5	15.0	7.5/15.0	0.6	500	100	500	100	500	
332	0.0033	18.5	9.5	6.0	15.0	7.5/15.0	0.6	500	100	500	100	500	18.5	9.5	6.0	15.0	7.5/15.0	0.6	500	100	500	100	500	18.5	9.5	6.0	15.0	7.5/15.0	0.6	500	100	500	100	500	
392	0.0039	18.5	9.5	6.0	15.0	7.5/15.0	0.6	500	100	500	100	500	18.5	9.5	6.0	15.0	7.5/15.0	0.6	500	100	500	100	500	18.5	9.5	6.0	15.0	7.5/15.0	0.6	500	100	500	100	500	
472	0.0047	18.5	11.0	6.0	15.0	7.5/15.0	0.6	500	100	500	100	500	18.5	11.0	6.0	15.0	7.5/15.0	0.6	500	100	500	100	500	18.5	11.0	6.0	15.0	7.5/15.0	0.6	500	100	500	100	500	
582	0.0056	18.5	9.5	6.0	15.0	7.5/15.0	0.6	500	100	500	100	500	18.5	9.5	6.0	15.0	7.5/15.0	0.6	500	100	500	100	500	18.5	9.5	6.0	15.0	7.5/15.0	0.6	500	100	500	100	500	
682	0.0068	18.5	10.0	6.0	15.0	7.5/15.0	0.6	500	100	500	100	500	18.5	10.0	6.0	15.0	7.5/15.0	0.6	500	100	500	100	500	18.5	10.0	6.0	15.0	7.5/15.0	0.6	500	100	500	100	500	
822	0.0082	18.5	9.0	5.5	15.0	7.5/15.0	0.6	500	100	500	100	500	18.5	9.0	5.5	15.0	7.5/15.0	0.6	500	100	500	100	500	18.5	9.0	5.5	15.0	7.5/15.0	0.6	500	100	500	100	500	
103	0.010	18.5	9.5	6.0	15.0	7.5/15.0	0.6	500	100	500	100	500	18.5	9.5	6.0	15.0	7.5/15.0	0.6	500	100	500	100	500	18.5	9.5	6.0	15.0	7.5/15.0	0.6	500	100	500	100	500	
123	0.012	18.5	11.0	6.0	15.0	7.5/15.0	0.6	500	100	500	100	500	18.5	11.0	6.0	15.0	7.5/15.0	0.6	500	100	500	100	500	18.5	11.0	6.0	15.0	7.5/15.0	0.6	500	100	500	100	500	
153	0.015	18.5	9.5	6.0	15.0	7.5/15.0	0.6	500	100	500	100	500	18.5	11.5	6.0	15.0	7.5/15.0	0.6	500	100	500	100	500	18.5	11.5	6.0	15.0	7.5/15.0	0.6	500	100	500	100	500	
183	0.018	18.5	11.0	6.0	15.0	7.5/15.0	0.6	500	100	500	100	500	18.5	12.0	6.5	15.0	7.5/15.0	0.6	400	100	500	100	500	18.5	12.0	6.5	15.0	7.5/15.0	0.6	400	100	500	100	500	
223	0.022	18.5	11.5	6.0	15.0	7.5/15.0	0.6	500	100	500	100	500	18.5	12.5	7.0	15.0	7.5/15.0	0.6	400	100	500	100	500	18.5	12.5	7.0	15.0	7.5/15.0	0.6	400	100	500	100	500	
273	0.027	18.5	12.5	7.0	15.0	7.5/15.0	0.6	400	100	500	100	500	18.5	13.0	8.0	15.0	7.5/15.0	0.6	300	100	500	100	500	18.5	13.0	8.0	15.0	7.5/15.0	0.6	300	100	500	100	500	
333	0.033	23.5	11.5	6.5	20.0	15.0/20.0	0.8	400	100	500	100	500	23.5	12.5	7.0	20.0	15.0/20.0	0.8	400	50	250	50	250	23.5	12.5	7.0	20.0	15.0/20.0	0.8	400	50	250	50	250	
393	0.039	23.5	12.0	7.0	20.0	15.0/20.0	0.8	400	100	500	100	500	23.5	13.0	7.5	20.0	15.0/20.0	0.8	400	50	250	50	250	23.5	13.0	7.5	20.0	15.0/20.0	0.8	400	50	250	50	250	
473	0.047	23.5	12.5	7.5	20.0	15.0/20.0	0.8	400	100	500	100	500	23.5	14.5	7.5	20.0	15.0/20.0	0.8	400	50	250	50	250	23.5	14.5	7.5	20.0	15.0/20.0	0.8	400	50	250	50	250	
583	0.056	23.5	14.0	7.5	20.0	15.0/20.0	0.8	400	50	300	50	300	23.5	16.0	8.0	20.0	15.0/20.0	0.8	300	50	250	50	250	23.5	16.0	8.0	20.0	15.0/20.0	0.8	300	50	250	50	250	
683	0.068	23.5	17.0	7.0	20.0	15.0/20.0	0.8	400	50	300	50	300	23.5	18.0	8.0	20.0	15.0/20.0	0.8	300	50	250	50	250	23.5	18.0	8.0	20.0	15.0/20.0	0.8	300	50	250	50	250	
823	0.082	23.5	17.5	7.5	20.0	15.0/20.0	0.8	400	50	300	50	300	23.5	18.5	9.0	20.0	15.0/20.0	0.8	300	50	250	50	250	23.5	18.5	9.0	20.0	15.0/20.0	0.8	300	50	250	50	250	
104	0.10	23.5	18.5	8.5	20.0	15.0/20.0	0.8	300	50	300	50	300	23.5	19.5	9.5	20.0	15.0/20.0	0.8	300	25	250	25	250	23.5	19.5	9.5	20.0	15.0/20.0	0.8	300	25	250	25	250	
124	0.12	28.5	17.5	7.5	25.0	15.0/25.0	0.8		25	150	25	150	28.5	19.0	9.0	25.0	15.0/25.0	0.8		25	150	25	150	28.5	19.0	9.0	25.0	15.0/25.0	0.8		25	150	25	150	
154	0.15	28.5	18.5	8.5	25.0	15.0/25.0	0.8		25	150	25	150	28.5	20.0	10.0	25.0	15.0/25.0	0.8		25	150	25	150	28.5	20.0	10.0	25.0	15.0/25.0	0.8		25	150	25	150	
184	0.18	28.5	20.5	9.0	25.0	15.0/25.0	0.8		25	150	25	150	28.5	22.0	10.5	25.0	15.0/25.0	0.8		25	150	25	150	28.5	22.0	10.5	25.0	15.0/25.0	0.8		25	150	25	150	
224	0.22	28.5	21.5	10.0	25.0	15.0/25.0	0.8		25	150	25	150	28.5	23.0	11.5	25.0	15.0/25.0	0.8		25	100	25	100	28.5	23.0	11.5	25.0	15.0/25.0	0.8		25	100	25	100	
274	0.27	28.5	22.5	11.0	25.0	15.0/25.0	0.8		25	150	25	150																							
334	0.33	28.5	23.5	12.0	25.0	15.0/25.0	0.8		25	150	25	150																							
394	0.39	28.5	23.5	13.5	25.0	15.0/25.0	0.8		20	100	20	100																							
474	0.47	28.5	25.0	15.0	25.0	15.0/25.0	0.8		20	100	20	100																							
564	0.56	28.5	26.5	17.5	25.0	15.0/25.0	0.8		20	100	20	100																							
684	0.68	28.5	27.5	19.0	25.0	15.0/25.0	0.8		10	50	10	50																							

周波数に対する許容電流特性/Characteristics of permissible current to frequency

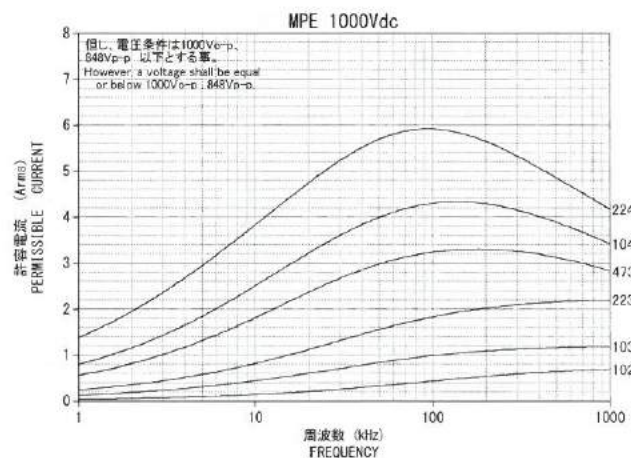
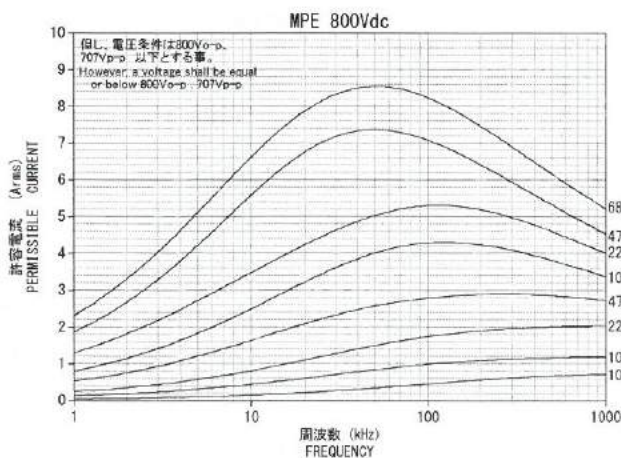

ご使用にあたっては、使用上の注意事項(9-16頁)をご確認の上、技術仕様書等をお求め願ひ、仕様書の範囲内でのご使用をお願いします。 When using our capacitors, please consider the application notes on pages 9-16 and contact NISSEI for any additional technical specifications relating to the limits of our performance characteristics.

METALLIZED POLYPROPYLENE FILM CAPACITOR

形状 Style	ストレートリード Straight lead type		フォーミング Forming lead type					
	W Max	T Max	F=15.0		F=20.0	F=25.0	F=7.5	F=15.0
Cap範囲 Cap range	1250Vdc 1600Vdc	102~184 102~104	102~163 102~912	183~513 103~203	563~184 223~104	102~163 102~912	183~184 103~104	183~184 103~104

テーピング仕様のリードピッチ寸法(F)は、6~7頁のテーピング寸法表をご参照下さい。
For a pitch space (F) of the taping specification, refer to "TAPING DIMENSIONS" on pages 6 to 7.

寸法/Dimensions (mm)

Cap CODE	Cap (μF)	MPE 1250Vdc										MPE 1600Vdc											
		W	H	T	P	F	φd	テーピング Taping	ロング Long	フォーミング Forming	テーピング Taping	ロング Long	フォーミング Forming										
102	0.0010	18.5	9.0	6.5	15.0	7.5/15.0	0.6	500	100	500	100	500	18.5	9.0	6.5	15.0	7.5/15.0	0.6	500	100	500	100	500
122	0.0012	18.5	9.5	6.0	15.0	7.5/15.0	0.6	500	100	500	100	500	18.5	9.5	6.0	15.0	7.5/15.0	0.6	500	100	500	100	500
152	0.0015	18.5	10.0	6.5	15.0	7.5/15.0	0.6	400	100	500	100	500	18.5	10.0	6.5	15.0	7.5/15.0	0.6	400	100	500	100	500
182	0.0018	18.5	10.5	7.0	15.0	7.5/15.0	0.6	400	100	500	100	500	18.5	10.5	7.0	15.0	7.5/15.0	0.6	400	100	500	100	500
222	0.0022	18.5	11.0	7.5	15.0	7.5/15.0	0.6	400	100	500	100	500	18.5	11.0	7.5	15.0	7.5/15.0	0.6	400	100	500	100	500
272	0.0027	18.5	11.5	8.0	15.0	7.5/15.0	0.6	400	100	500	100	500	18.5	11.5	8.0	15.0	7.5/15.0	0.6	400	100	500	100	500
332	0.0033	18.5	12.0	8.5	15.0	7.5/15.0	0.6	400	100	500	100	500	18.5	12.0	8.5	15.0	7.5/15.0	0.6	400	100	500	100	500
392	0.0039	18.5	12.5	9.0	15.0	7.5/15.0	0.6	400	100	500	100	500	18.5	12.5	9.0	15.0	7.5/15.0	0.6	400	100	500	100	500
472	0.0047	18.5	13.0	9.5	15.0	7.5/15.0	0.6	400	100	500	100	500	18.5	13.0	9.5	15.0	7.5/15.0	0.6	400	100	500	100	500
662	0.0066	18.5	13.5	10.0	15.0	7.5/15.0	0.6	400	100	500	100	500	18.5	13.5	10.0	15.0	7.5/15.0	0.6	400	100	500	100	500
682	0.0068	18.5	14.0	10.5	15.0	7.5/15.0	0.6	400	100	500	100	500	18.5	14.0	10.5	15.0	7.5/15.0	0.6	400	100	500	100	500
822	0.0082	18.5	14.5	11.0	15.0	7.5/15.0	0.6	400	100	500	100	500	18.5	14.5	11.0	15.0	7.5/15.0	0.6	400	100	500	100	500
103	0.010	18.5	15.0	11.5	15.0	7.5/15.0	0.8	400	100	500	100	500	23.5	12.5	7.5	20.0	15.0/20.0	0.8	400	50	250	50	250
123	0.012	18.5	15.5	12.0	15.0	7.5/15.0	0.8	400	100	500	100	500	23.5	13.0	8.0	20.0	15.0/20.0	0.8	300	50	250	50	250
153	0.015	18.5	16.0	12.5	15.0	7.5/15.0	0.8	400	100	500	100	500	23.5	13.5	8.5	20.0	15.0/20.0	0.8	300	50	250	50	250
183	0.018	23.5	12.0	7.0	20.0	15.0/20.0	0.8	400	100	500	100	500	23.5	16.5	8.0	20.0	15.0/20.0	0.8	300	50	250	50	250
223	0.022	23.5	13.0	7.5	20.0	15.0/20.0	0.8	400	50	300	50	300	28.5	15.0	8.0	25.0	15.0/25.0	0.8		25	250	25	250
273	0.027	23.5	13.5	8.0	20.0	15.0/20.0	0.8	400	50	300	50	300	28.5	15.5	8.5	25.0	15.0/25.0	0.8		25	250	25	250
333	0.033	23.5	14.0	8.5	20.0	15.0/20.0	0.8	300	50	250	50	250	28.5	16.0	9.0	25.0	15.0/25.0	0.8		25	250	25	250
393	0.039	23.5	14.5	9.0	20.0	15.0/20.0	0.8	300	50	250	50	250	28.5	16.5	9.5	25.0	15.0/25.0	0.8		25	250	25	250
473	0.047	23.5	15.0	9.5	20.0	15.0/20.0	0.8	300	50	250	50	250	28.5	17.0	10.0	25.0	15.0/25.0	0.8		25	200	25	200
562	0.056	28.5	19.0	7.5	25.0	15.0/25.0	0.8		50	250	50	200	28.5	23.5	10.0	25.0	15.0/25.0	0.8		25	150	25	150
683	0.068	28.5	21.0	8.0	25.0	15.0/25.0	0.8		25	250	25	200	28.5	24.5	11.5	25.0	15.0/25.0	0.8		25	150	25	150
823	0.082	28.5	21.5	8.5	25.0	15.0/25.0	0.8		25	200	25	200	28.5	25.5	12.5	25.0	15.0/25.0	0.8		25	150	25	150
104	0.10	28.5	22.5	9.5	25.0	15.0/25.0	0.8		25	200	25	200	28.5	27.0	14.0	25.0	15.0/25.0	0.8		25	100	25	100
124	0.12	28.5	23.5	10.5	25.0	15.0/25.0	0.8		25	200	25	150											
154	0.15	28.5	24.5	11.5	25.0	15.0/25.0	0.8		25	150	25	150											
184	0.18	28.5	26.0	13.0	25.0	15.0/25.0	0.8		25	150	25	150											

周波数に対する許容電流特性/Characteristics of permissible current to frequency

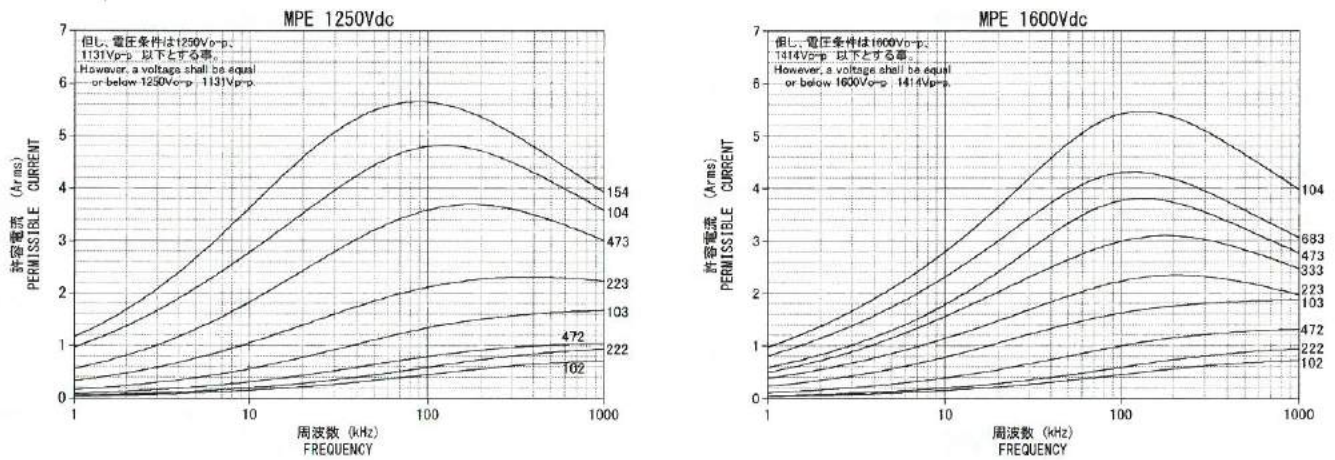

ご使用にあたっては、使用上の注意事項(9-16頁)をご確認の上、技術仕様書等をお求め願ひ、仕様書の範囲内でのご使用をお願いします。
When using our capacitors, please consider the application notes on pages 9-16 and contact NISSEI for any additional technical specifications relating to the limits of our performance characteristics.

特徴/Features

- 小型軽量化しております。
- 各種スイッチング電源用。
- 照明インバーター用

- ★It is smaller and lighter.
- ★Various SMPS
- ★Lighting inverters

規格/Specifications

使用温度範囲 Temp. range	-40~85°C (+105°C)*1
定格電圧 Rated voltage	450Vdc, 630Vdc
静電容量範囲 Capacitance	450Vdc 0.10~0.27μF (E-12) 630Vdc 0.10~2.2μF (E-12)
静電容量許容差 Cap. tolerance	±5% (J), ±10% (K)
誘電正接 Tangent of loss angle	0.001 _{25°C} (at 1kHz)
耐電圧 Voltage Proof	WV×150% 60sec or WV×175% 1~5 sec
絶縁抵抗 Insulation resistance	C ≤ 0.33μF 30,000MΩ _{25°C} (100Vdc/1 min) C > 0.33μF 7,500Ω F _{25°C}
高温負荷 Endurance	85°C 450Vdc WV×111% (500Vdc) 1000hr印加 630Vdc WV×125% (788Vdc) 1000hr印加 ΔC/C ±10% _{25°C} in tan δ 0.003 _{25°C} C ≤ 0.33μF 3,500MΩ _{25°C} C > 0.33μF 1,000Ω F _{25°C}
耐湿負荷 Damp heat	40°C 95%RH WV 500hr印加 ΔC/C ±10% _{25°C} in tan δ 0.003 _{25°C} C ≤ 0.33μF 3,500MΩ _{25°C} C > 0.33μF 1,000Ω F _{25°C}

*1 () 温度は電圧軽減による使用可能範囲です。

*1 () Marked temperature shows operatable when voltage is derated.

周波数に対する許容電流特性/Characteristics of permissible current to frequency

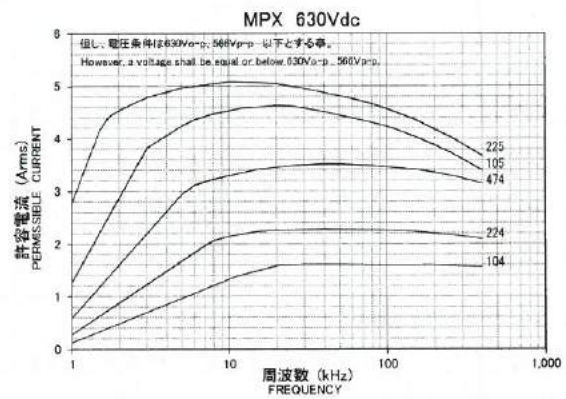
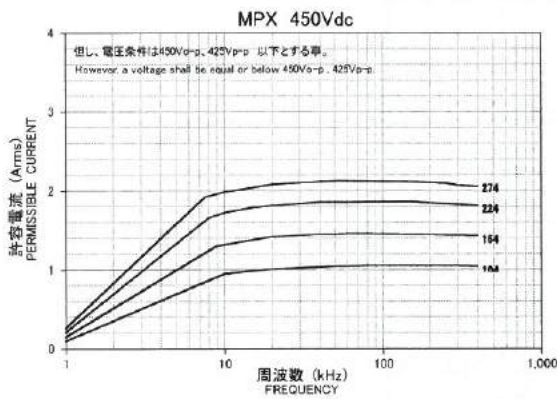

ご使用にあたっては、使用上の注意事項(9-16頁)をご確認の上、技術仕様書等をお求め願ひ、仕様書の範囲内でのご使用をお願いいたします。

When using our capacitors, please consider the application notes on pages 9-16 and contact NISSEI for any additional technical specifications relating to the limits of our performance characteristics.

寸法/Dimensions (mm)

形状 Style	ストレートリード Straight lead type		フォーミング Forming lead type	
Cap 範囲	450Vdc	104~274	F= 5.0 F= 7.5 F=10.0	104~274
Cap range	630Vdc	104~225	F= 5.0 F= 7.5 F=10.0 F=15.0 F=17.5 F=22.5	104~105 104~105 104~105 104~105 125~225

テーピング仕様のリードピッチ寸法(F)は、6~7頁のテーピング寸法表をご参照下さい。
For a pitch space (F) of the taping specification, refer to "TAPING DIMENSIONS" on pages 6 to 7.

Cap CODE	Cap (μF)	MPX 450Vdc							基準収納数 NUMBER OF PIECES FOR PACKING UNIT				
		W	H	T	P	F	φ d	テーピング Taping	ロング Long		フォーミング Formed		
104	0.10	13.0	8.3	5.0	10.0	5.0/7.5/10.0	0.6	500	100	1,000	100	1,000	
124	0.12	13.0	8.5	5.3	10.0	5.0/7.5/10.0	0.8	500	100	1,000	100	1,000	
154	0.15	13.0	9.0	5.6	10.0	5.0/7.5/10.0	0.6	500	100	1,000	100	1,000	
184	0.18	13.0	9.5	6.0	10.0	5.0/7.5/10.0	0.6	400	100	1,000	100	1,000	
224	0.22	13.0	9.9	6.4	10.0	5.0/7.5/10.0	0.6	400	100	1,000	100	1,000	
274	0.27	13.0	10.4	6.9	10.0	5.0/7.5/10.0	0.6	400	100	500	100	500	

Cap CODE	Cap (μF)	MPX 630Vdc							基準収納数 NUMBER OF PIECES FOR PACKING UNIT				
		W	H	T	P	F	φ d	テーピング Taping	ロング Long		フォーミング Formed		
104	0.10	18.3	9.0	5.8	15.0	5.0/7.5/10.0/15.0	0.6	500	100	500	100	500	
124	0.12	18.3	9.3	6.1	15.0	5.0/7.5/10.0/15.0	0.6	500	100	500	100	500	
154	0.15	18.3	9.9	6.8	15.0	5.0/7.5/10.0/15.0	0.6	400	100	500	100	500	
184	0.18	18.3	10.6	7.4	15.0	5.0/7.5/10.0/15.0	0.6	400	100	500	100	500	
224	0.22	18.3	11.6	7.6	15.0	5.0/7.5/10.0/15.0	0.6	400	100	500	100	500	
274	0.27	18.3	12.1	8.1	15.0	5.0/7.5/10.0/15.0	0.6	300	100	500	100	500	
334	0.33	18.3	12.7	8.8	15.0	5.0/7.5/10.0/15.0	0.8	300	100	500	100	500	
394	0.39	18.3	13.4	9.3	15.0	5.0/7.5/10.0/15.0	0.8	300	100	500	100	500	
474	0.47	18.3	14.7	9.8	15.0	5.0/7.5/10.0/15.0	0.8	300	50	300	50	300	
564	0.56	18.3	15.5	10.8	15.0	5.0/7.5/10.0/15.0	0.8	200	50	300	50	300	
684	0.68	18.3	16.7	11.7	15.0	5.0/7.5/10.0/15.0	0.8		50	200	50	200	
824	0.82	18.3	17.7	12.6	15.0	5.0/7.5/10.0/15.0	0.8		50	200	50	200	
105	1.0	18.3	19.8	13.1	15.0	5.0/7.5/10.0/15.0	0.8		20	100	20	100	
125	1.2	25.5	18.0	11.5	22.5	17.5/22.5	0.8		20	100	20	100	
155	1.5	25.5	19.3	12.8	22.5	17.5/22.5	0.8		20	100	20	100	
185	1.8	25.5	20.7	14.0	22.5	17.5/22.5	0.8		20	100	20	100	
225	2.2	25.5	22.0	15.5	22.5	17.5/22.5	0.8		20	100	20	100	

ご使用にあたっては、使用上の注意事項(9-16頁)をご確認の上、技術仕様書等をお求め願ひ、仕様書の範囲内でのご使用をお願いします。 When using our capacitors, please consider the application notes on pages 9-16 and contact NISSEI for any additional technical specifications relating to the limits of our performance characteristics.

特徴/Features

- 小型軽量化しております。
- 低うなり音

- ★It is smaller and lighter.
- ★Low beat sound

規格/Specifications

使用温度範囲 Temp. range	-40~85°C (+110°C)※1
定格電圧 Rated voltage	450Vdc
静電容量 Capacitance	0.33~4.7μF
静電容量許容差 Cap. tolerance	±10% (K)
誘電正接 Tangent of loss angle	0.0010 _{100V, 1kHz} (at 1kHz)
耐電圧 Voltage Proof	WV×150% 60sec or WV×175% 1~5 sec
絶縁抵抗 Insulation resistance	C ≤ 0.33μF 30,000MΩ _{100V, 1min} C > 0.33μF 7,500Ω F _{100V, 1min} (100V. dc/1 min)
高温負荷 Endurance	85°C 500Vdc 1000hr印加 ΔC/C ±10% _{100V, 1min} tanδ 0.003 _{100V, 1min} IR C ≤ 0.33μF 3,500MΩ _{100V, 1min} C > 0.33μF 1,000Ω F _{100V, 1min}
耐湿負荷 Damp heat	85°C 85%RH 450Vdc 500hr印加 ΔC/C ±10% _{100V, 1min} tanδ 0.01 _{100V, 1min} IR C ≤ 0.33μF 3,500MΩ _{100V, 1min} C > 0.33μF 1,000Ω F _{100V, 1min}

※1 () 温度は電圧軽減による使用可能範囲です。

※1 () Marked temperature shows operatable when voltage is derated.

寸法/Dimensions (mm)

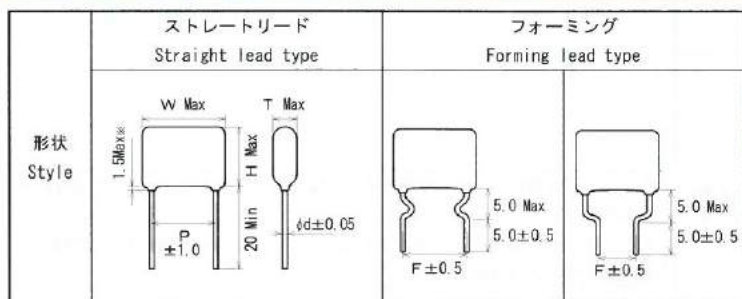

テーピング仕様のリードピッチ寸法(F)は、6~7頁のテーピング寸法表をご参照下さい。

For a pitch space (F) of the taping specification, refer to "TAPING DIMENSIONS" on pages 6 to 7.

Cap CODE	Cap (μF)	EDP CODE	MPW 450Vdc											
			標準収納数 NUMBER OF PIECES FOR PACKING UNIT											
			W	H	T	P	F	φ d	テーピング Taping		ロング Long		フォーミング Formed	
Ammo		Bag							Box	Bag	Box			
								F=5.0	F=7.5					
334	0.33	01Z9	12.5	11.0	5.5	10.0	5.0/7.5/10.0	0.6	500	500	100	500	100	500
474	0.47	01Z9	12.5	14.0	5.5	10.0	5.0/7.5/10.0	0.6	500	500	100	500	100	500
684	0.68	01Z9	12.5	15.8	6.5	10.0	5.0/7.5/10.0	0.6	500	400	100	500	100	500
684	0.68	0000	18.0	12.0	5.8	15.0	5.0/7.5/10.0/15.0	0.8	500	500	100	500	100	500
105	1.0	01Z9	12.5	17.4	8.0	10.0	5.0/7.5/10.0	0.6	400	300	100	500	100	500
105	1.0	0000	18.0	13.0	7.0	15.0	5.0/7.5/10.0/15.0	0.8	400	400	100	500	100	500
155	1.5	0000	18.0	15.4	9.0	15.0	5.0/7.5/10.0/15.0	0.8	300	300	50	300	50	300
225	2.2	0000	18.0	17.2	10.8	15.0	5.0/7.5/10.0/15.0	0.8		200	50	200	50	200
335	3.3	0000	18.0	20.0	13.3	15.0	5.0/7.5/10.0/15.0	0.8			50	200	50	200
475	4.7	0000	18.0	23.5	15.0	15.0	5.0/7.5/10.0/15.0	0.8			25	150	25	150

ご使用にあたっては、使用上の注意事項(9-16頁)をご確認の上、技術仕様書等をお求め願ひ、仕様書の範囲内でのご使用をお願いします。

When using our capacitors, please consider the application notes on pages 9-16 and contact NISSEI for any additional technical specifications relating to the limits of our performance characteristics.

特徴/Features

- 小型軽量化しております。
- 低うなり音

- ★It is smaller and lighter.
- ★Low beat sound

規格/Specifications

使用温度範囲 Temp. range	-40~85°C (+110°C)*1
定格電圧 Rated voltage	450Vdc
静電容量 Capacitance	0.47~4.7μF
静電容量許容差 Cap. tolerance	±10% (K)
誘電正接 Tangent of loss angle	0.0020 ²⁵ T _{loss} (at 1kHz)
耐電圧 Voltage Proof	WV×150% 60sec
絶縁抵抗 Insulation resistance	7,500Ω F _{500Vdc} (100V.dc/1 min)
高温負荷 Endurance	85°C 500Vdc 1000hr印加 ΔC/C ±10% ⁸⁵ in tan δ 0.006 ⁸⁵ T _{loss} IR 1,000Ω F _{500Vdc}
耐湿負荷 Damp heat	40°C 95%RH 450Vdc 500hr印加 ΔC/C ±10% ⁴⁰ in tan δ 0.01 ⁴⁰ T _{loss} IR C ≤ 0.33μF 3,500MΩ F _{500Vdc} C > 0.33μF 1,000Ω F _{500Vdc}

*1 () 温度は電圧軽減による使用可能範囲です。

*1 () Marked temperature shows operatable when voltage is derated.

寸法/Dimensions (mm)

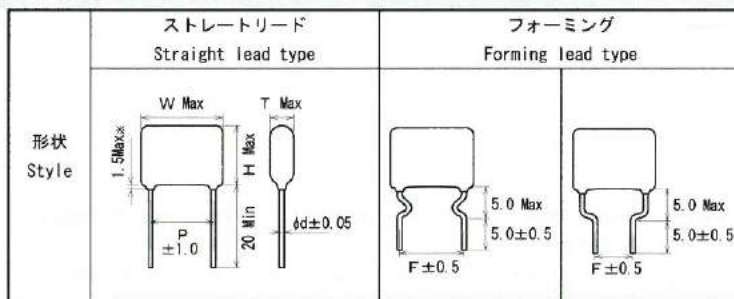

テーピング仕様のリードピッチ寸法(F)は、6~7頁のテーピング寸法表をご参照下さい。
For a pitch space (F) of the taping specification, refer to "TAPING DIMENSIONS" on pages 6 to 7.

Cap CODE	Cap (μF)	EDP CODE	MPW (X) 450Vdc							基準収納数 NUMBER OF PIECES FOR PACKING UNIT				
			W	H	T	P	F	φ d	テーピング Taping		ロング Long		フォーミング Formed	
									F=5.0	F=7.5	Bag	Box	Bag	Box
474	0.47	0129	12.5	11.2	4.3	10.0	5.0/7.5/10.0	0.6	500	500	100	500	100	500
474	0.47	0000	18.0	8.0	4.3	15.0	5.0/7.5/10.0/15.0	0.6	500	500	100	500	100	500
684	0.68	0129	12.5	11.9	5.0	10.0	5.0/7.5/10.0	0.6	500	500	100	500	100	500
684	0.68	0000	18.0	8.6	4.8	15.0	5.0/7.5/10.0/15.0	0.6	500	500	100	500	100	500
105	1.0	0129	12.5	13.9	5.5	10.0	5.0/7.5/10.0	0.6	500	500	100	500	100	500
105	1.0	0000	18.0	9.3	5.8	15.0	5.0/7.5/10.0/15.0	0.6	500	500	100	500	100	500
155	1.5	0129	12.5	15.3	6.9	10.0	5.0/7.5/10.0	0.6	500	400	100	500	100	500
155	1.5	0000	18.0	10.5	6.8	15.0	5.0/7.5/10.0/15.0	0.6	500	400	100	500	100	500
225	2.2	0129	12.5	16.8	8.3	10.0	5.0/7.5/10.0	0.8	250	250	100	500	100	500
225	2.2	0000	18.0	11.7	8.2	15.0	5.0/7.5/10.0/15.0	0.8	400	250	100	500	100	500
335	3.3	0129	12.5	20.1	9.9	10.0	5.0/7.5/10.0	0.8		250	50	300	50	300
335	3.3	0000	18.0	14.9	9.1	15.0	5.0/7.5/10.0/15.0	0.8		250	50	300	50	300
475	4.7	0129	12.5	24.4	10.9	10.0	5.0/7.5/10.0	0.8			50	300	50	300
475	4.7	0000	18.0	18.5	10.8	15.0	5.0/7.5/10.0/15.0	0.8			50	300	50	300

ご使用にあたっては、使用上の注意事項(9-16頁)をご確認の上、技術仕様書等をお求め願ひ、仕様書の範囲内でのご使用をお願いします。 When using our capacitors, please consider the application notes on pages 9-16 and contact NISSEI for any additional technical specifications relating to the limits of our performance characteristics.

特徴/Features

- 小型軽量化しております。
- 低うなり音

- ★It is smaller and lighter.
- ★Low beat sound

規格/Specifications

使用温度範囲 Temp. range	-40~85°C (+110°C)*1
定格電圧 Rated voltage	450Vdc
静電容量 Capacitance	0.47~2.2μF
静電容量許容差 Cap. tolerance	±10% (K)
誘電正接 Tangent of loss angle	0.0020 _{tanδ_{ess}} (at 1kHz)
耐電圧 Voltage Proof	1WV×150% 60sec
絶縁抵抗 Insulation resistance	7,500Ω F _{of more} (100V.dc/1 min)
高温負荷 Endurance	85°C 500Vdc 1000hr印加 ΔC/C ±10% _{of in} tan δ 0.006 _{tanδ_{ess}} IR 1,000Ω F _{of more}
耐湿負荷 Damp heat	60°C 95%RH 450Vdc 500hr印加 ΔC/C ±10% _{of in} tan δ 0.003 _{tanδ_{ess}} IR 1,000Ω F _{of more}

*1 () 温度は電圧軽減による使用可能範囲です。

*1 () Marked temperature shows operatable when voltage is derated.

寸法/Dimensions (mm)

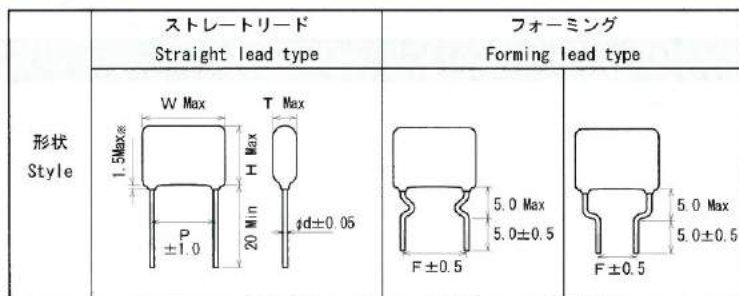

テーピング仕様のリードピッチ寸法(F)は、6~7頁のテーピング寸法表をご参照下さい。
For a pitch space (F) of the taping specification, refer to "TAPING DIMENSIONS" on pages 6 to 7.

Cap CODE	Cap (μF)	EDP CODE	MPW (Z) 450Vdc															
			基準取納数 NUMBER OF PIECES FOR PACKING UNIT										テーピング Taping		ロング Long		フォーミング Formed	
			W	H	T	P	F	φ d	Ammo		Bag	Box	Bag	Box				
									F=5.0	F=7.5								
474	0.47	01Z9	12.5	11.7	4.6	10.0	5.0/7.5/10.0	0.6	500	500	100	500	100	500				
684	0.68	01Z9	12.5	13.5	5.3	10.0	5.0/7.5/10.0	0.6	500	500	100	500	100	500				
105	1.0	01Z9	12.5	14.8	6.2	10.0	5.0/7.5/10.0	0.6	500	500	100	500	100	500				
155	1.5	01Z9	12.5	17.5	7.8	10.0	5.0/7.5/10.0	0.6	400	300	100	500	100	500				
225	2.2	01Z9	12.5	18.4	10.2	10.0	5.0/7.5/10.0	0.8			100	500	100	500				

ご使用にあたっては、使用上の注意事項(9-16頁)をご確認の上、技術仕様書等をお求め願ひ、仕様書の範囲内でのご使用をお願いします。

When using our capacitors, please consider the application notes on pages 9-16 and contact NISSEI for any additional technical specifications relating to the limits of our performance characteristics.

特徴/Features

- 小型軽量化しております。
- 各種スイッチング電源用。
- 照明インバーター用
- 低うなり品

- ★It is smaller and lighter.
- ★Various SMPS
- ★Lighting inverters
- ★Low beat sound

規格/Specifications

使用温度範囲 Temp. range	-40~85°C (+105°C)※1
定格電圧 Rated voltage	250V~1000Vdc
静電容量 Capacitance	250Vdc 6.8, 8.2, 10.0, 15.0 μF 400Vdc 2.2 μF 630Vdc 0.47, 1.0, 3.3 μF 800Vdc 1.0 μF 1000Vdc 0.47, 1.0 μF
静電容量許容差 Cap. tolerance	±5% (J), ±10% (K)
誘電正接 Tangent of loss angle	0.0005 _{tan δ} (at 1kHz)
耐電圧 Voltage Proof	WV×150% 60sec or WV×175% 1~5 sec
絶縁抵抗 Insulation resistance	10,000 Ω F _{IR} (100Vdc/1 min)
高温負荷 Endurance	85°C WV×125% 1000hr印加 ΔC/C ±5% _{規格 in} tan δ 0.0008 _{tan δ} IR 5,000 Ω F _{IR}
耐湿負荷 Damp heat	40°C 95%RH WV 500hr印加 ΔC/C ±5% _{規格 in} tan δ 0.0008 _{tan δ} IR 3,000 Ω F _{IR}

※1 () 温度は電圧軽減による使用可能範囲です。

※1 () Marked temperature shows operatable when voltage is derated.

寸法/Dimensions (mm)

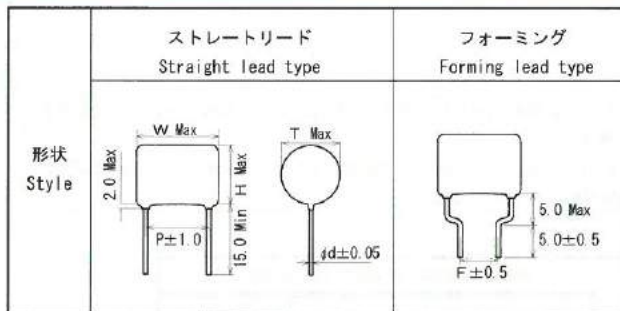

Rated Voltage	Cap CODE	Cap (μF)	MPE (A)										
			MPE (A)							ロング Long		フォーミング Formed	
			W	H	T	P	F	φd	Bag	Box	Bag	Box	
250Vdc	685	6.8	31.5	21.0	19.6	27.5	22.5	1.0	10	70	10	70	
	925	8.2	31.5	25.0	21.5	27.5	22.5	1.0	10	50	10	50	
	106	10.0	31.5	24.6	23.1	27.5	22.5	1.0	10	50	10	50	
	156	15.0	31.5	29.3	27.5	27.5	22.5	1.0	10	30	10	30	
400Vdc	225	2.2	26.5	19.8	18.4	22.5	17.5	0.8	20	100	20	100	
	474	0.47	21.5	17.6	16.4	17.5	12.5	0.8	25	150	25	150	
	105	1.0	26.5	20.4	19.0	22.5	17.5	0.8	20	100	20	100	
630Vdc	335	3.3	31.5	30.3	28.5	27.5	22.5	1.0	10	30	10	30	
	105	1.0	31.5	21.6	20.2	27.5	22.5	1.0	10	50	10	50	
800Vdc	105	1.0	31.5	21.6	20.2	27.5	22.5	1.0	10	50	10	50	
	474	0.47	26.5	22.5	21.0	22.5	17.5	0.8	10	50	10	50	
1000Vdc	105	1.0	31.5	27.4	25.6	27.5	22.5	1.0	10	40	10	40	
	105	1.0	31.5	27.4	25.6	27.5	22.5	1.0	10	40	10	40	

個別設計品のため、コンデンサの電圧・電流波形等の使用条件をご確認の上弊社営業までお問い合わせ下さい。
This is a custom-made product. Please contact our sales representatives and inform them of the conditions under which the capacitor will be used, such as voltage and current waveform.

ご使用にあたっては、使用上の注意事項(9-16頁)をご確認の上、技術仕様書等をお求め願ひ、仕様書の範囲内でのご使用をお願いします。 When using our capacitors, please consider the application notes on pages 9-16 and contact NISSEI for any additional technical specifications relating to the limits of our performance characteristics.

特徴/Features

- 低損失。
- 高周波高電圧回路用。

- ★Low dissipation factor.
- ★High voltage circuit for high frequency

規格/Specifications

使用温度範囲 Temp. range	-40~105°C	
定格電圧 Rated voltage	2000, 3000Vdc	
静電容量 Capacitance	2000Vdc	0.01, 0.047 μ F
	3000Vdc	0.0024~0.0082 μ F
静電容量許容差 Cap. tolerance	±5% (J)	
誘電正接 Tangent of loss angle	0.0010 _{25°C} (at 1kHz)	
耐電圧 Voltage Proof	2000Vdc	2000Vac 1min.
	3000Vdc	4500Vdc 10sec
絶縁抵抗 Insulation resistance	30,000M Ω _{50%}	

寸法/Dimensions (mm)

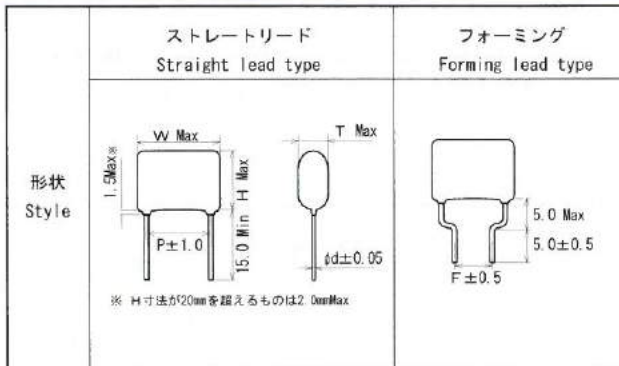

Rated Voltage	Cap. CODE	Cap (μ F)	外形寸法 (mm)					
			W	H	T	P	F	ϕ d
2000Vdc	103	0.01	18.5	18.0	11.0	15.0	-	0.8
	473	0.047	27.0	21.5	12.0	24.0	-	0.8
3000Vdc	242	0.0024	26.0	15.5	7.0	22.5	22.5	1.0
	392	0.0039	26.0	15.5	7.5	22.5	22.5	1.0
	432	0.0043	26.0	15.5	8.5	22.5	22.5	1.0
	562	0.0056	26.0	14.5	7.5	22.5	22.5	1.0
	822	0.0082	26.0	15.5	9.0	22.5	22.5	1.0

個別設計品のため、コンデンサの電圧・電流波形等の使用条件をご確認の上弊社営業までお問い合わせ下さい。
This is a custom-made product. Please contact our sales representatives and inform them of the conditions under which the capacitor will be used, such as voltage and current waveform.

特徴/Features

- オーディオ用としてリード線に無酸素銅線 (φ0.6mm) を使用したMTF(A)があります。MTF(A)は全てフォーミング品です。MTFF、MTFVいずれかの型名でご注文下さい。
- 0.01~1.0μFまで、リードピッチ寸法は5.0mmで統一されており、自動挿入用テーピング品はストレートおよびフォーミングのいずれも可能です。

- ★We have MTF(A) type where oxygen-free copper wires are used as lead wires and all lead wires of MTF(A) type are formed.
- ★When ordering, please tell us which type you require among MTFF and MTFV.
- ★Standardized 5.0 mm lead spacing from 0.01 to 1.0 μF and available both in lead formed type and straight lead type for auto insertion.

規格/Specifications

使用温度範囲 Temp. range	-40~+85°C (+105°C)*
定格電圧 Rated voltage	50V, 63V, 100V, 250Vdc
静電容量範囲 Capacitance	50Vdc 0.010~3.3μF (E-12) 63Vdc 0.010~3.3μF (E-12) 100Vdc 0.010~1.0μF (E-12) 250Vdc 0.010~0.22μF (E-12)
静電容量許容差 Cap. tolerance	±5% (J)
誘電正接 Tangent of loss angle	0.01 $\tan \delta_{\text{ess}}$ (at 1kHz)
絶縁抵抗 Insulation resistance	$C \leq 0.33 \mu F$ 3,000Ω F_{thre} $C > 0.33 \mu F$ 1,000Ω F_{thre}
高温負荷 Endurance	85°C WV × 125% 1000hr印加 $\Delta C/C \pm 5\%$ $\tan \delta \leq 0.01 \tan \delta_{\text{ess}}$ IR $C \leq 0.33 \mu F$ 1,000MΩ F_{thre} $C > 0.33 \mu F$ 300Ω F_{thre}
耐湿負荷 Damp heat	40°C 90~95%RH WV 500hr印加 $\Delta C/C \pm 7\%$ $\tan \delta \leq 0.011 \tan \delta_{\text{ess}}$ IR $C \leq 0.33 \mu F$ 100MΩ F_{thre} $C > 0.33 \mu F$ 30Ω F_{thre}

※ () 温度は電圧軽減による使用可能範囲です。

※ () Marked temperature shows operatable range when voltage is derated.

形状 Style	ストレートリード Straight lead type	フォーミング Forming lead type	
	<p>※ MMT(A), MTF(A) 50V, MMT100V, 250V P±1.0 MMT63V P±1.5</p>		
Cap範囲 Cap range	MMT(A) 50Vdc	103~335	103~335
	MMT 63Vdc	103~335	103~335
	MMT 100Vdc	103~105	103~105
	MMT 250Vdc	103~224	103~224
MTF(A) 50Vdc			103~335

テーピング仕様のリードピッチ寸法(F)は、6~7頁のテーピング寸法表をご参照下さい。
For a pitch space (F) of the taping specification, refer to "TAPING DIMENSIONS" on pages 6 to 7.

周波数に対する許容電流特性/Characteristics of permissible current to frequency

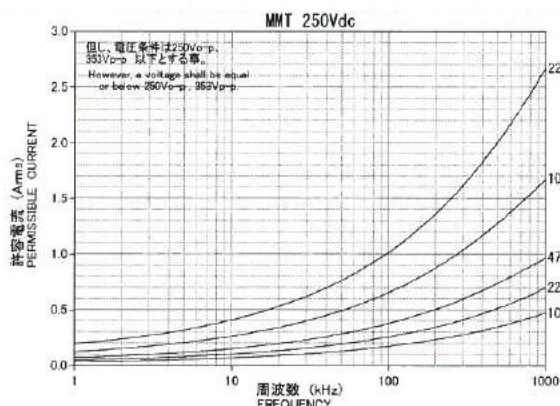
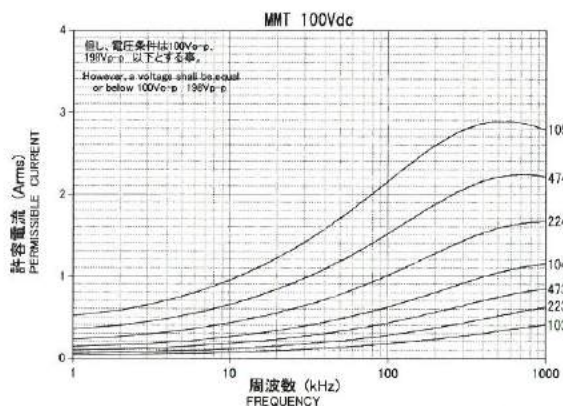
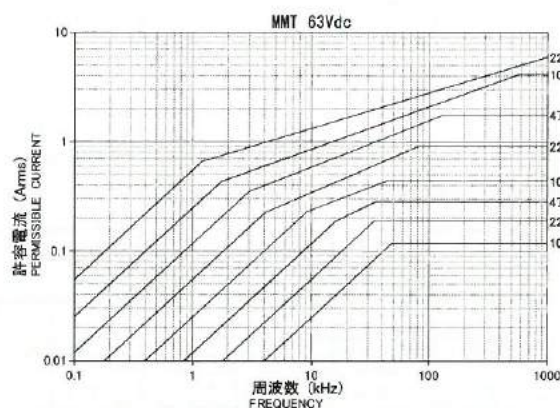
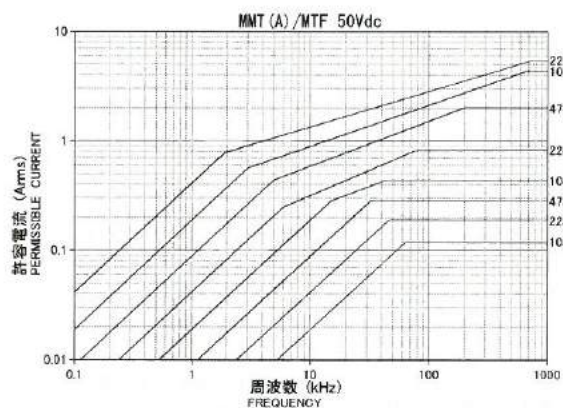

ご使用にあたっては、使用上の注意事項(9-16頁)をご確認の上、技術仕様書等をお求め願ひ、仕様書の範囲内でのご使用をお願いします。 When using our capacitors, please consider the application notes on pages 9-16 and contact NISSEI for any additional technical specifications relating to the limits of our performance characteristics.

寸法/Dimensions (mm)

Cap CODE	Cap (μF)	基準収納数 NUMBER OF PIECES FOR PACKING UNIT															基準収納数 NUMBER OF PIECES FOR PACKING UNIT																										
		MMT (A) 50Vdc							MTF (A) 50Vdc								MMT 63Vdc							MTF (A) 50Vdc								MMT 63Vdc											
		W	H	T	P	F	φd	Armo	Bag	Box	Bag	Box	W	H	T	P	F	φd	Armo	Bag	Box	W	H	T	P	F	φd	Armo	Bag	Box	W	H	T	P	F	φd	Armo	Bag	Box	Bag	Box		
103	0.010	7.3	5.0	3.2	5.0	5.0	0.5	2,000	200	4,000	200	6,000	7.3	5.0	3.2	5.0	5.0	0.6	2,000	200	6,000	8.0	5.0	3.2	5.0	5.0	0.5	2,000	200	4,000	200	6,000	8.0	5.0	3.2	5.0	5.0	0.5	2,000	200	4,000	200	6,000
123	0.012	7.3	5.0	3.2	5.0	5.0	0.5	2,000	200	4,000	200	6,000	7.3	5.0	3.2	5.0	5.0	0.6	2,000	200	6,000	8.0	5.0	3.2	5.0	5.0	0.5	2,000	200	4,000	200	6,000	8.0	5.0	3.2	5.0	5.0	0.5	2,000	200	4,000	200	6,000
153	0.015	7.3	5.0	3.2	5.0	5.0	0.5	2,000	200	4,000	200	6,000	7.3	5.0	3.2	5.0	5.0	0.6	2,000	200	6,000	8.0	5.0	3.2	5.0	5.0	0.5	2,000	200	4,000	200	6,000	8.0	5.0	3.2	5.0	5.0	0.5	2,000	200	4,000	200	6,000
183	0.018	7.3	5.0	3.2	5.0	5.0	0.5	2,000	200	4,000	200	6,000	7.3	5.0	3.2	5.0	5.0	0.6	2,000	200	6,000	8.0	5.0	3.2	5.0	5.0	0.5	2,000	200	4,000	200	6,000	8.0	5.0	3.2	5.0	5.0	0.5	2,000	200	4,000	200	6,000
223	0.022	7.3	5.0	3.2	5.0	5.0	0.5	2,000	200	4,000	200	6,000	7.3	5.0	3.2	5.0	5.0	0.6	2,000	200	6,000	8.0	5.0	3.2	5.0	5.0	0.5	2,000	200	4,000	200	6,000	8.0	5.0	3.2	5.0	5.0	0.5	2,000	200	4,000	200	6,000
273	0.027	7.3	5.0	3.2	5.0	5.0	0.5	2,000	200	4,000	200	6,000	7.3	5.0	3.2	5.0	5.0	0.6	2,000	200	6,000	8.0	5.0	3.2	5.0	5.0	0.5	2,000	200	4,000	200	6,000	8.0	5.0	3.2	5.0	5.0	0.5	2,000	200	4,000	200	6,000
333	0.033	7.3	5.0	3.2	5.0	5.0	0.5	2,000	200	4,000	200	6,000	7.3	5.0	3.2	5.0	5.0	0.6	2,000	200	6,000	8.0	5.0	3.2	5.0	5.0	0.5	2,000	200	4,000	200	6,000	8.0	5.0	3.2	5.0	5.0	0.5	2,000	200	4,000	200	6,000
393	0.039	7.3	5.0	3.2	5.0	5.0	0.5	2,000	200	4,000	200	6,000	7.3	5.0	3.2	5.0	5.0	0.6	2,000	200	6,000	8.0	5.0	3.2	5.0	5.0	0.5	2,000	200	4,000	200	6,000	8.0	5.0	3.2	5.0	5.0	0.5	2,000	200	4,000	200	6,000
473	0.047	7.3	5.0	3.2	5.0	5.0	0.5	2,000	200	4,000	200	6,000	7.3	5.0	3.2	5.0	5.0	0.6	2,000	200	6,000	8.0	5.0	3.2	5.0	5.0	0.5	2,000	200	4,000	200	6,000	8.0	5.0	3.2	5.0	5.0	0.5	2,000	200	4,000	200	6,000
563	0.056	7.3	5.0	3.2	5.0	5.0	0.5	2,000	200	4,000	200	6,000	7.3	5.0	3.2	5.0	5.0	0.6	2,000	200	6,000	8.0	5.0	3.2	5.0	5.0	0.5	2,000	200	4,000	200	6,000	8.0	5.0	3.2	5.0	5.0	0.5	2,000	200	4,000	200	6,000
683	0.068	7.3	5.0	3.2	5.0	5.0	0.5	2,000	200	4,000	200	6,000	7.3	5.0	3.2	5.0	5.0	0.6	2,000	200	6,000	8.0	5.0	3.2	5.0	5.0	0.5	2,000	200	4,000	200	6,000	8.0	5.0	3.2	5.0	5.0	0.5	2,000	200	4,000	200	6,000
823	0.082	7.3	5.0	3.2	5.0	5.0	0.5	2,000	200	4,000	200	6,000	7.3	5.0	3.2	5.0	5.0	0.6	2,000	200	6,000	8.0	5.0	3.2	5.0	5.0	0.5	2,000	200	4,000	200	6,000	8.0	5.0	3.2	5.0	5.0	0.5	2,000	200	4,000	200	6,000
104	0.10	7.3	5.0	3.2	5.0	5.0	0.5	2,000	200	4,000	200	6,000	7.3	5.0	3.2	5.0	5.0	0.6	2,000	200	6,000	8.0	5.0	3.2	5.0	5.0	0.5	2,000	200	4,000	200	6,000	8.0	5.0	3.2	5.0	5.0	0.5	2,000	200	4,000	200	6,000
124	0.12	7.3	5.0	3.2	5.0	5.0	0.5	2,000	200	4,000	200	6,000	7.3	5.0	3.2	5.0	5.0	0.6	2,000	200	6,000	8.0	5.0	3.2	5.0	5.0	0.5	2,000	200	4,000	200	6,000	8.0	5.0	3.2	5.0	5.0	0.5	2,000	200	4,000	200	6,000
154	0.15	7.3	5.5	3.5	5.0	5.0	0.5	2,000	200	4,000	200	6,000	7.3	5.5	3.5	5.0	5.0	0.6	2,000	200	6,000	8.0	5.5	3.5	5.0	5.0	0.5	2,000	200	4,000	200	6,000	8.0	5.5	3.5	5.0	5.0	0.5	2,000	200	4,000	200	6,000
184	0.18	7.3	5.5	4.0	5.0	5.0	0.5	2,000	200	4,000	200	6,000	7.3	5.5	4.0	5.0	5.0	0.6	2,000	200	6,000	8.0	5.5	4.0	5.0	5.0	0.5	2,000	200	4,000	200	6,000	8.0	5.5	4.0	5.0	5.0	0.5	2,000	200	4,000	200	6,000
224	0.22	7.3	5.5	4.3	5.0	5.0	0.5	2,000	200	3,000	200	4,000	7.3	5.5	4.3	5.0	5.0	0.6	2,000	200	4,000	8.0	5.5	4.3	5.0	5.0	0.5	2,000	200	3,000	200	4,000	8.0	5.5	4.3	5.0	5.0	0.5	2,000	200	3,000	200	4,000
274	0.27	7.3	6.5	4.3	5.0	5.0	0.5	1,000	200	3,000	200	4,000	7.3	6.5	4.3	5.0	5.0	0.6	1,000	200	4,000	8.0	6.5	4.3	5.0	5.0	0.5	1,000	200	3,000	200	4,000	8.0	6.5	4.3	5.0	5.0	0.5	1,000	200	3,000	200	4,000
334	0.33	7.3	6.5	4.8	5.0	5.0	0.5	1,000	200	3,000	200	4,000	7.3	6.5	4.8	5.0	5.0	0.6	1,000	200	4,000	8.0	6.5	4.8	5.0	5.0	0.5	1,000	200	3,000	200	4,000	8.0	6.5	4.8	5.0	5.0	0.5	1,000	200	3,000	200	4,000
394	0.39	7.3	7.0	5.0	5.0	5.0	0.5	1,000	200	2,000	200	3,000	7.3	7.0	5.0	5.0	5.0	0.6	1,000	200	3,000	8.0	7.0	5.0	5.0	5.0	0.5	1,000	200	2,000	200	3,000	8.0	7.0	5.0	5.0	5.0	0.5	1,000	200	2,000	200	3,000
474	0.47	7.3	8.0	5.5	5.0	5.0	0.5	1,000	200	2,000	200	3,000	7.3	8.0	5.5	5.0	5.0	0.6	1,000	200	3,000	8.0	8.0	5.5	5.0	5.0	0.5	1,000	200	2,000	200	3,000	8.0	8.0	5.5	5.0	5.0	0.5	1,000	200	2,000	200	3,000
564	0.56	7.3	8.0	5.8	5.0	5.0	0.5	1,000	200	2,000	200	3,000	7.3	8.0	5.8	5.0	5.0	0.6	1,000	200	3,000	8.0	8.0	5.8	5.0	5.0	0.5	1,000	200	2,000	200	3,000	8.0	8.0	5.8	5.0	5.0	0.5	1,000	200	2,000	200	3,000
684	0.68	7.3	8.5	6.5	5.0	5.0	0.5	1,000	200	2,000	200	3,000	7.3	8.5	6.5	5.0	5.0	0.6	1,000	200	3,000	8.0	8.5	6.5	5.0	5.0	0.5	1,000	200	2,000	200	3,000	8.0	8.5	6.5	5.0	5.0	0.5	1,000	200	2,000	200	3,000
824	0.82	7.3	9.5	6.5	5.0	5.0	0.5	1,000	200	2,000	200	2,000	7.3	9.5	6.5	5.0	5.0	0.6	1,000	200	2,000	8.0	9.5	6.5	5.0	5.0	0.5	1,000	200	2,000	200	2,000	8.0	9.5	6.5	5.0	5.0	0.5	1,000	200	2,000	200	2,000
105	1.0	7.3	9.5	7.5	5.0	5.0	0.5	1,000	200	2,000	200	2,000	7.3	9.5	7.5	5.0	5.0	0.6	1,000	200	2,000	8.0	11.0	5.3	5.0	5.0	0.5	1,000	200	2,000	200	2,000	8.0	11.0	5.3	5.0	5.0	0.5	1,000	200	2,000	200	2,000
125	1.2	10.0	9.5	5.5	7.5	5.0	0.5	1,000	100	1,000	100	1,500	10.0	9.5	5.5	7.5	5.0	0.6	1,000	100	1,500	11.0	10.0	4.7	7.5	5.0	0.5	1,000	100	1,000	100	1,500	11.0	10.0	4.7	7.5	5.0	0.5	1,000	100	1,000	100	1,500
155	1.5	10.0	9.5	6.5	7.5	5.0	0.5	1,000	100	1,000	100	1,500	10.0	9.5	6.5	7.5	5.0	0.6	1,000	100	1,500	11.0	11.0	5.0	7.5	5.0	0.5	1,000	100	1,000	100	1,500	11.0	11.0	5.0	7.5	5.0	0.5	1,000	100	1,000	100	1,500
185	1.8	10.0	11.0	6.5	7.5	5.0	0.5	100	1,000	100	1,500	10.0	11.0	6.5	7.5	5.0	0.6	100	1,000	1,500	11.0	11.0	5.5	7.5	5.0	0.5	100	1,000	100	1,500	11.0	11.0	5.5	7.5	5.0	0.5	100	1,000	100	1,500			
225	2.2	10.0	11.0	7.0	7.5	5.0	0.5	100	1,000	100	1,500	10.0	11.0	7.0	7.5	5.0	0.6	100	1,000	1,500	11.0	12.0	6.0	7.5	5.0	0.5	100	1,000	100	1,500	11.0	12.0	6.0	7.5	5.0	0.5	100	1,000	100	1,500			
275	2.7	10.0	13.5	7.0	7.5	5.0	0.5	100	1,000	100	1,000	10.0	13.5	7.0	7.5	5.0	0.6	100	1,000	1,000	11.0	13.5	6.5	7.5	5.0	0.5	100	1,000	100	1,000	11.0	13.5	6.5	7.5	5.0	0.5	100	1,000	100	1,000			
335	3.3	10.0	13.5	8.0	7.5	5.0	0.5	100	1,000	100	1,000	10.0	13.5	8.0	7.5	5.0	0.6	100	1,000	1,000	11.0	13.5	7.0	7.5	5.0	0.5	100	1,000	100	1,000	11.0	13.5	7.0	7.5	5.0	0.5	100	1,000	100				

特徴/Features

●外装は最新のエポキシ加工により難燃性のエポキシ樹脂による均一な厚さで覆われていますので小型軽量となっています。

★Uniform flame-retardant epoxy resin coating through the latest resin technology.
This provides miniature size and light weight.

規格/Specifications

使用温度範囲 Temp. range	-40~+85°C (+105°C)*	誘電正接 Tangent of loss angle	0.01 ₁₀₀ (at 1kHz)
定格電圧 Rated voltage	50V, 63V, 100V, 250, 450, 630Vdc	絶縁抵抗 Insulation resistance	C ≤ 0.33 μF 3,000 Ω ₁₀₀ C > 0.33 μF 1,000 Ω ₁₀₀
静電容量範囲 Capacitance	50Vdc/63Vdc 0.010 ~ 3.3 μF (E-12)	高温負荷 Endurance	85°C WV×125% 1000hr印加 ΔC/C ±5% ₁₀₀ in tan δ 0.01 ₁₀₀
	100Vdc 0.010 ~ 1.0 μF (E-12)		IR C ≤ 0.33 μF 1,000M Ω ₁₀₀ C > 0.33 μF 300 Ω ₁₀₀
静電容量許容差 Cap. tolerance	±5% (J)	耐湿負荷 Damp heat	40°C 90~95%RH WV 500hr印加 ΔC/C ±7% ₁₀₀ in tan δ 0.011 ₁₀₀
			IR C ≤ 0.33 μF 100M Ω ₁₀₀ C > 0.33 μF 30 Ω ₁₀₀

※ () 温度は電圧降下による使用可能範囲です。

※ () Marked temperature shows operatable range when voltage is derated.

形状 Style	ストレートリード Straight lead type		フォーミング Forming lead type	
Cap範囲 Cap range	50Vdc/63Vdc	103~335	103~105	125~335
	100Vdc	103~105	103~105	
	250Vdc	102~334	102~154	184~334
	450Vdc	102~104	102~333	393~104
	630Vdc	102~103	102~103	

テーピング仕様のリードピッチ寸法(F)は、6~7頁のテーピング寸法表をご参照下さい。
For a pitch space (F) of the taping specification, refer to "TAPING DIMENSIONS" on pages 6 to 7.

寸法/Dimensions (mm)

Cap CODE	Cap (μF)	MMT (B) 50Vdc/63Vdc										
		基本取組数 NUMBER OF PIECES FOR PACKING UNIT										
		テーピング Taping		ロング Long		フォーミング Formed		テーピング Taping		ロング Long		フォーミング Formed
W	H	T	P	F	φd	Ammo	Bag	Box	Bag	Box	Bag	Box
103	0.010	7.2	5.0	3.0	5.0	5.0	0.5	2,000	500	4,000	200	6,000
123	0.012	7.2	5.0	3.0	5.0	5.0	0.5	2,000	500	4,000	200	6,000
153	0.015	7.2	5.0	3.0	5.0	5.0	0.5	2,000	500	4,000	200	6,000
183	0.018	7.2	5.0	3.0	5.0	5.0	0.5	2,000	500	4,000	200	6,000
223	0.022	7.2	5.0	3.0	5.0	5.0	0.5	2,000	500	4,000	200	6,000
273	0.027	7.2	5.0	3.0	5.0	5.0	0.5	2,000	500	4,000	200	6,000
333	0.033	7.2	5.0	3.0	5.0	5.0	0.5	2,000	500	4,000	200	6,000
393	0.039	7.2	5.0	3.0	5.0	5.0	0.5	2,000	500	4,000	200	6,000
473	0.047	7.2	5.0	3.0	5.0	5.0	0.5	2,000	500	4,000	200	6,000
563	0.056	7.2	5.0	3.0	5.0	5.0	0.5	2,000	500	4,000	200	6,000
683	0.068	7.2	5.0	3.0	5.0	5.0	0.5	2,000	500	4,000	200	6,000
823	0.082	7.2	5.0	3.0	5.0	5.0	0.5	2,000	500	4,000	200	6,000
104	0.10	7.2	5.0	3.0	5.0	5.0	0.5	2,000	500	4,000	200	6,000
124	0.12	7.2	5.0	3.0	5.0	5.0	0.5	2,000	500	4,000	200	6,000
154	0.15	7.2	5.5	3.5	5.0	5.0	0.5	2,000	500	4,000	200	6,000
184	0.18	7.2	5.5	3.5	5.0	5.0	0.5	2,000	500	4,000	200	6,000
224	0.22	7.2	5.5	4.3	5.0	5.0	0.5	2,000	200	3,000	200	4,000
274	0.27	7.2	6.5	4.3	5.0	5.0	0.5	1,000	200	3,000	200	4,000
334	0.33	7.2	6.5	4.8	5.0	5.0	0.5	1,000	200	3,000	200	4,000
394	0.39	7.2	7.0	5.0	5.0	5.0	0.5	1,000	200	2,000	200	3,000
474	0.47	7.2	7.5	5.5	5.0	5.0	0.5	1,000	200	2,000	200	3,000
564	0.56	7.2	8.0	5.8	5.0	5.0	0.5	1,000	200	2,000	200	3,000
684	0.68	7.2	8.5	6.5	5.0	5.0	0.5	1,000	200	2,000	200	3,000
824	0.82	7.2	9.0	7.0	5.0	5.0	0.5	1,000	200	2,000	200	3,000
105	1.0	7.2	9.5	7.5	5.0	5.0	0.5	1,000	200	2,000	200	2,000
125	1.2	10.0	9.5	8.5	7.5	5.0	0.5	1,000	100	1,000	100	1,500
155	1.5	10.0	9.5	8.5	7.5	5.0	0.5	1,000	100	1,000	100	1,500
185	1.8	10.0	11.0	8.5	7.5	5.0	0.5	1,000	100	1,000	100	1,300
225	2.2	10.0	11.0	7.0	7.5	5.0	0.5	1,000	100	1,000	100	1,500
275	2.7	10.0	13.5	7.0	7.5	5.0	0.5	1,000	100	1,000	100	1,000
335	3.3	10.0	13.5	8.0	7.5	5.0	0.5	1,000	100	1,000	100	1,000

周波数に対する許容電流特性

Characteristics of permissible current to frequency

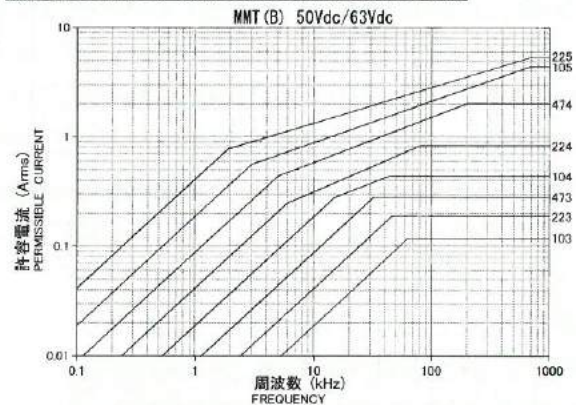

ご使用にあたっては、使用上の注意事項(9-16頁)をご確認の上、技術仕様書等をお求め願ひ、仕様書の範囲内でのご使用をお願いします。 When using our capacitors, please consider the application notes on pages 9-16 and contact NISSEI for any additional technical specifications relating to the limits of our performance characteristics.

寸法 / Dimensions (mm)

Cap CODE	Cap (μF)	MMT (B) 450Vdc												MMT (B) 630Vdc																				
		基本収納数 NUMBER OF PIECES FOR PACKING UNIT												基本収納数 NUMBER OF PIECES FOR PACKING UNIT																				
		テーピング Taping						ロング Long			フォーミング Formed			テーピング Taping						ロング Long			フォーミング Formed											
W	H	T	P	F	φ d	Ammo	Bag	Box	Bag	Box	Ammo	Bag	Box	W	H	T	P	F	φ d	Ammo	Bag	Box	Bag	Box	Ammo	Bag	Box							
102	0.0010	7.2	5.0	3.2	5.0	5.0	0.5	2,000	500	4,000	200	6,000	7.2	5.0	3.2	5.0	5.0	0.5	2,000	500	4,000	200	6,000	7.2	5.0	3.2	5.0	5.0	0.5	2,000	500	4,000	200	6,000
122	0.0012	7.2	5.0	3.2	5.0	5.0	0.5	2,000	500	4,000	200	6,000	7.2	5.0	3.2	5.0	5.0	0.5	2,000	500	4,000	200	6,000	7.2	5.0	3.2	5.0	5.0	0.5	2,000	500	4,000	200	6,000
152	0.0015	7.2	5.0	3.2	5.0	5.0	0.5	2,000	500	4,000	200	6,000	7.2	5.0	3.2	5.0	5.0	0.5	2,000	500	4,000	200	6,000	7.2	5.0	3.2	5.0	5.0	0.5	2,000	500	4,000	200	6,000
182	0.0018	7.2	5.0	3.2	5.0	5.0	0.5	2,000	500	4,000	200	6,000	7.2	5.0	3.2	5.0	5.0	0.5	2,000	500	4,000	200	6,000	7.2	5.0	3.2	5.0	5.0	0.5	2,000	500	4,000	200	6,000
222	0.0022	7.2	5.0	3.2	5.0	5.0	0.5	2,000	500	4,000	200	6,000	7.2	6.0	3.5	5.0	5.0	0.5	2,000	500	4,000	200	6,000	7.2	6.0	3.5	5.0	5.0	0.5	2,000	500	4,000	200	6,000
272	0.0027	7.2	5.0	3.2	5.0	5.0	0.5	2,000	500	4,000	200	6,000	7.2	7.0	3.5	5.0	5.0	0.5	2,000	500	4,000	200	6,000	7.2	7.0	3.5	5.0	5.0	0.5	2,000	500	4,000	200	6,000
332	0.0033	7.2	5.0	3.5	5.0	5.0	0.5	2,000	500	4,000	200	6,000	7.2	6.5	4.0	5.0	5.0	0.5	2,000	200	3,000	200	4,000	7.2	6.5	4.0	5.0	5.0	0.5	2,000	200	3,000	200	4,000
392	0.0039	7.2	6.0	3.5	5.0	5.0	0.5	2,000	500	4,000	200	6,000	7.2	7.5	4.0	5.0	5.0	0.5	2,000	200	3,000	200	4,000	7.2	7.5	4.0	5.0	5.0	0.5	2,000	200	3,000	200	4,000
472	0.0047	7.2	6.0	4.0	5.0	5.0	0.5	2,000	500	4,000	200	6,000	7.2	7.5	4.5	5.0	5.0	0.5	1,000	200	3,000	200	4,000	7.2	7.5	4.5	5.0	5.0	0.5	1,000	200	3,000	200	4,000
562	0.0056	7.2	6.5	4.0	5.0	5.0	0.5	2,000	200	3,000	200	4,000	7.2	6.5	4.5	5.0	5.0	0.5	1,000	200	2,000	200	3,000	7.2	6.5	4.5	5.0	5.0	0.5	1,000	200	2,000	200	3,000
682	0.0068	7.2	6.5	4.5	5.0	5.0	0.5	1,000	200	3,000	200	4,000	7.2	9.0	4.5	5.0	5.0	0.5	1,000	200	2,000	200	3,000	7.2	9.0	4.5	5.0	5.0	0.5	1,000	200	2,000	200	3,000
822	0.0082	7.2	7.5	4.5	5.0	5.0	0.5	1,000	200	3,000	200	4,000	7.2	9.0	5.0	5.0	5.0	0.5	1,000	200	2,000	200	3,000	7.2	9.0	5.0	5.0	5.0	0.5	1,000	200	2,000	200	3,000
103	0.010	7.2	6.0	4.3	5.0	5.0	0.5	1,000	200	3,000	200	4,000	7.2	9.0	5.5	5.0	5.0	0.5	1,000	200	2,000	200	3,000	7.2	9.0	5.5	5.0	5.0	0.5	1,000	200	2,000	200	3,000
123	0.012	7.2	6.5	4.3	5.0	5.0	0.5	1,000	200	3,000	200	4,000	7.2	9.0	5.0	5.0	5.0	0.5	1,000	200	2,000	200	3,000	7.2	9.0	5.0	5.0	5.0	0.5	1,000	200	2,000	200	3,000
153	0.015	7.2	7.5	4.3	5.0	5.0	0.5	1,000	200	3,000	200	4,000	7.2	9.0	5.0	5.0	5.0	0.5	1,000	200	2,000	200	3,000	7.2	9.0	5.0	5.0	5.0	0.5	1,000	200	2,000	200	3,000
183	0.018	7.2	8.5	4.5	5.0	5.0	0.5	1,000	200	2,000	200	3,000	7.2	8.5	4.5	5.0	5.0	0.5	1,000	200	2,000	200	3,000	7.2	8.5	4.5	5.0	5.0	0.5	1,000	200	2,000	200	3,000
223	0.022	7.2	9.5	4.5	5.0	5.0	0.5	1,000	200	2,000	200	3,000	7.2	9.5	4.5	5.0	5.0	0.5	1,000	200	2,000	200	3,000	7.2	9.5	4.5	5.0	5.0	0.5	1,000	200	2,000	200	3,000
273	0.027	7.2	8.5	5.5	5.0	5.0	0.5	1,000	200	2,000	200	3,000	7.2	8.5	5.5	5.0	5.0	0.5	1,000	200	2,000	200	3,000	7.2	8.5	5.5	5.0	5.0	0.5	1,000	200	2,000	200	3,000
333	0.033	7.2	9.5	5.5	5.0	5.0	0.5	1,000	200	2,000	200	3,000	7.2	9.5	5.5	5.0	5.0	0.5	1,000	200	2,000	200	3,000	7.2	9.5	5.5	5.0	5.0	0.5	1,000	200	2,000	200	3,000
393	0.039	9.8	7.0	4.2	7.5	5.0	0.5	2,000	200	1,600	200	1,600	9.8	7.0	4.2	7.5	5.0	0.5	2,000	200	1,600	200	1,600	9.8	7.0	4.2	7.5	5.0	0.5	2,000	200	1,600	200	1,600
473	0.047	9.8	7.2	4.2	7.5	5.0	0.5	2,000	200	1,600	200	1,600	9.8	7.2	4.2	7.5	5.0	0.5	2,000	200	1,600	200	1,600	9.8	7.2	4.2	7.5	5.0	0.5	2,000	200	1,600	200	1,600
563	0.056	9.8	8.0	4.2	7.5	5.0	0.5	2,000	200	1,600	200	1,600	9.8	8.0	4.2	7.5	5.0	0.5	2,000	200	1,600	200	1,600	9.8	8.0	4.2	7.5	5.0	0.5	2,000	200	1,600	200	1,600
683	0.068	9.8	8.3	4.4	7.5	5.0	0.5	2,000	100	1,500	100	1,500	9.8	8.3	4.4	7.5	5.0	0.5	2,000	100	1,500	100	1,500	9.8	8.3	4.4	7.5	5.0	0.5	2,000	100	1,500	100	1,500
823	0.082	9.8	8.0	4.8	7.5	5.0	0.5	1,000	100	1,500	100	1,500	9.8	8.0	4.8	7.5	5.0	0.5	1,000	100	1,500	100	1,500	9.8	8.0	4.8	7.5	5.0	0.5	1,000	100	1,500	100	1,500
104	0.10	9.8	10.8	4.5	7.5	5.0	0.5	1,000	100	1,000	100	1,000	9.8	10.8	4.5	7.5	5.0	0.5	1,000	100	1,000	100	1,000	9.8	10.8	4.5	7.5	5.0	0.5	1,000	100	1,000	100	1,000

周波数に対する許容電流特性 / Characteristics of permissible current to frequency

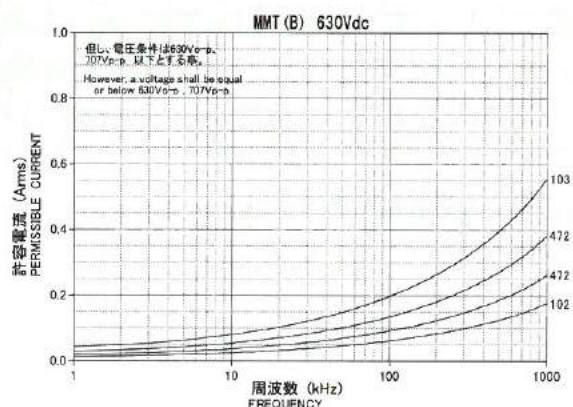
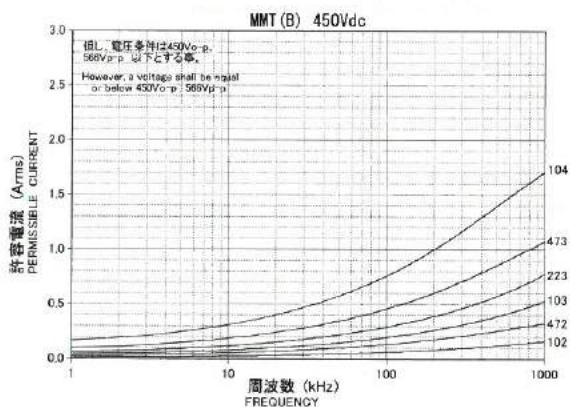

ご使用にあたっては、使用上の注意事項(9-16頁)をご確認の上、技術仕様書等をお求め願ひ、仕様書の範囲内でのご使用をお願いします。 When using our capacitors, please consider the application notes on pages 9-16 and contact NISSEI for any additional technical specifications relating to the limits of our performance characteristics.

特徴/Features

- 小型軽量化
- 点火装置 (CDI) 用

- ★It is smaller and lighter.
- ★Ignition device (CDI)

規格/Specifications

使用温度範囲 Temp. range	-40~85°C (+105°C)※1
定格電圧 Rated voltage	250Vdc
静電容量 Capacitance	0.47~1.2μF
静電容量許容差 Cap. tolerance	±5% (J), ±10% (K)
誘電正接 Tangent of loss angle	0.010 _{DFmax} (at 1kHz)
耐電圧 Voltage Proof	WV×150% 60sec or WV×175% 1~5 sec
絶縁抵抗 Insulation resistance	EDP CODE 0000 : 3,000Ω F _{DFmax} (100Vdc/1 min) EDP CODE 0A20, 0A60 : 500Ω F _{DFmax} (100Vdc/1 min) EDP CODE 0A34 : 3,000Ω F _{DFmax} (100Vdc/1 min)

※1 () 温度は電圧軽減による使用可能範囲です。

※1 () Marked temperature shows operatable when voltage is derated.

寸法/Dimensions (mm)

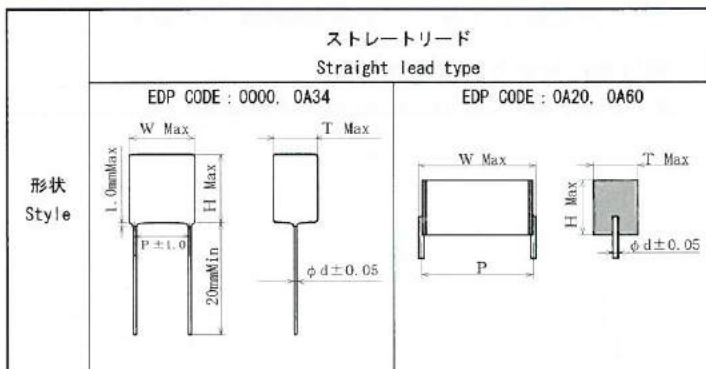

EDP CODE	Cap. CODE	Cap (μF)	外形寸法 (mm)				
			W	H	T	P	φ d
0000	105	1.0	13.0	13.0	8.0	10.0	0.6
	125	1.2	13.0	14.5	8.0	10.0	0.6
0A34	105	1.0	13.0	14.0	7.5	10.0	0.6
	125	1.2	13.0	16.0	7.5	10.0	0.6
0A20	474	0.47	11.4	9.0	4.5	10.0	0.6
	684	0.68	11.4	13.0	5.0	10.0	0.6
0A60	684	0.68	16.5	8.5	6.4	15.0	0.8
	105	1.0	16.5	9.0	8.0	15.0	0.8

個別設計品のため、コンデンサの電圧・電流波形等の使用条件をご確認の上弊社営業までお問い合わせ下さい。
This is a custom-made product. Please contact our sales representatives and inform them of the conditions under which the capacitor will be used, such as voltage and current waveform.

特徴/Features

- フロー、リフロー両用はんだ付けタイプです。
- 小型軽量かつ広い容量範囲で使用できます。
- 温度や周波数の変化に対して静電容量と誘電正接が安定しています。
- 広い使用温度範囲を持っています。(-55°C~+125°C)

- ★Suitable for flow and reflow soldering.
- ★Small size, Light weight type and applicable for wide range capacitance.
- ★Flat capacitance changes and tangent of loss angle for temperature and frequency.
- ★Applicable for wide range temperature. (-55~+125°C)

規格/Specifications

使用温度範囲 Temp. range	-55~+125°C
定格電圧 Rated voltage	16V, 50V, dc
静電容量範囲 Capacitance	16Vdc 0.00010~0.1μF (E-12シリーズ) 50Vdc 0.00010~0.22μF (E-12シリーズ)
静電容量許容差 Cap. tolerance	±2%(G), ±5%(J)
誘電正接 Tangent of loss angle	0.006 _{tanδ} (at 1kHz)
絶縁抵抗 Insulation resistance	3,000MΩ _{1000hr}
高温負荷 Endurance	125°C WV×125% 1000hr印加 ΔC/C ±2% _{1000hr} tanδ 0.006 _{tanδ} IR 1,000MΩ _{1000hr}
耐湿負荷 Damp heat	85°C 85%RH WV 500hr印加 ΔC/C ±10% _{1000hr} tanδ 0.012 _{tanδ} IR 10MΩ _{1000hr}

推奨ランド寸法/Recommended landing dimensions

製品寸法 L×W Dimensions	推奨ランド寸法(mm) Recommended landing dimensions		
	A	B	C
2.0×1.25	0.8	2.4	1.1
3.2×1.6	1.8	3.6	1.4
3.2×2.5	1.8	3.6	2.3
4.8×3.3	2.6	6.6	3.0
6.0×4.1	3.8	7.8	3.8

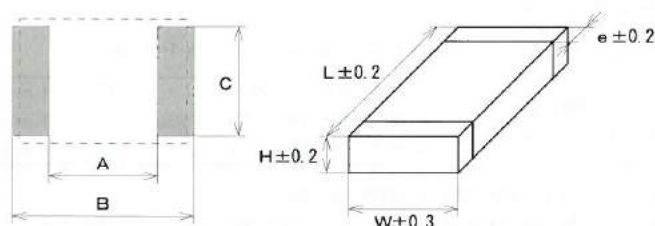

テーピング仕様は、8頁 ※テーピング寸法表をご参照下さい。

Taping specification, refer to "Taping DIMENSIONS" on page 8.

寸法/Dimensions (mm)

Cap CODE	Cap (μF)	CHA 16Vdc					基本収納数 NUMBER OF PIECES FOR PACKING UNIT	CHA 50Vdc					基本収納数 NUMBER OF PIECES FOR PACKING UNIT		
		L	W	H	e	テーピング Taping		L	W	H	e	テーピング Taping			
						Reel						Reel		Reel	Reel
101	0.00010	2.0	1.25	0.9	0.35	3,000	2.0	1.25	0.9	0.35	3,000	3,000			
121	0.00012	2.0	1.25	0.9	0.35	3,000	2.0	1.25	0.9	0.35	3,000	3,000			
151	0.00015	2.0	1.25	0.9	0.35	3,000	2.0	1.25	0.9	0.35	3,000	3,000			
181	0.00018	2.0	1.25	0.9	0.35	3,000	2.0	1.25	0.9	0.35	3,000	3,000			
221	0.00022	2.0	1.25	0.9	0.35	3,000	2.0	1.25	0.9	0.35	3,000	3,000			
271	0.00027	2.0	1.25	0.9	0.35	3,000	2.0	1.25	0.9	0.35	3,000	3,000			
331	0.00033	2.0	1.25	0.9	0.35	3,000	2.0	1.25	0.9	0.35	3,000	3,000			
391	0.00039	2.0	1.25	0.9	0.35	3,000	2.0	1.25	0.9	0.35	3,000	3,000			
471	0.00047	2.0	1.25	0.9	0.35	3,000	2.0	1.25	0.9	0.35	3,000	3,000			
561	0.00056	2.0	1.25	0.9	0.35	3,000	2.0	1.25	0.9	0.35	3,000	3,000			
681	0.00068	2.0	1.25	0.9	0.35	3,000	2.0	1.25	0.9	0.35	3,000	3,000			
821	0.00082	2.0	1.25	0.9	0.35	3,000	2.0	1.25	0.9	0.35	3,000	3,000			
102	0.0010	2.0	1.25	0.9	0.35	3,000	2.0	1.25	0.9	0.35	3,000	3,000			
122	0.0012	2.0	1.25	0.9	0.35	3,000	2.0	1.25	0.9	0.35	3,000	3,000			
152	0.0015	2.0	1.25	0.9	0.35	3,000	2.0	1.25	0.9	0.35	3,000	3,000			
182	0.0018	2.0	1.25	0.9	0.35	3,000	2.0	1.25	0.9	0.35	3,000	3,000			
222	0.0022	2.0	1.25	0.9	0.35	3,000	2.0	1.25	0.9	0.35	3,000	3,000			
272	0.0027	2.0	1.25	0.9	0.35	3,000	2.0	1.25	0.9	0.35	3,000	3,000			
332	0.0033	2.0	1.25	0.9	0.35	3,000	3.2	1.6	1.1	0.35	3,000	3,000			
392	0.0039	2.0	1.25	0.9	0.35	3,000	3.2	1.6	1.1	0.35	3,000	3,000			
472	0.0047	2.0	1.25	0.9	0.35	3,000	3.2	1.6	1.1	0.35	3,000	3,000			
562	0.0056	2.0	1.25	0.9	0.35	3,000	3.2	1.6	1.1	0.35	3,000	3,000			
682	0.0068	2.0	1.25	0.9	0.35	3,000	3.2	1.6	1.1	0.35	3,000	3,000			
822	0.0082	2.0	1.25	1.1	0.35	3,000	3.2	1.6	1.1	0.35	3,000	3,000			
103	0.010	2.0	1.25	1.2	0.35	3,000	3.2	1.6	1.1	0.35	3,000	3,000			
123	0.012	3.2	1.6	0.9	0.35	3,000	3.2	2.5	1.1	0.35	2,000	2,000			
153	0.015	3.2	1.6	0.9	0.35	3,000	3.2	2.5	1.1	0.35	2,000	2,000			
183	0.018	3.2	1.6	0.9	0.35	3,000	3.2	2.5	1.2	0.35	2,000	2,000			
223	0.022	3.2	1.6	0.9	0.35	3,000	3.2	2.5	1.6	0.35	2,000	2,000			
273	0.027	3.2	1.6	1.1	0.35	3,000	3.2	2.5	1.6	0.35	2,000	2,000			
333	0.033	3.2	1.6	1.1	0.35	3,000	3.2	2.5	2.0	0.35	2,000	2,000			
393	0.039	3.2	1.6	1.6	0.35	2,000	3.2	2.5	2.1	0.35	2,000	2,000			
473	0.047	3.2	1.6	1.5	0.35	2,000	4.8	3.3	1.4	0.35	3,000	3,000			
563	0.056	3.2	2.5	1.4	0.35	2,000	4.8	3.3	1.4	0.35	3,000	3,000			
683	0.068	3.2	2.5	1.5	0.35	2,000	4.8	3.3	1.6	0.35	3,000	3,000			
823	0.082	3.2	2.5	1.6	0.35	2,000	4.8	3.3	1.6	0.35	3,000	3,000			
104	0.10	3.2	2.5	1.9	0.35	2,000	4.8	3.3	2.1	0.35	3,000	3,000			
124	0.12						6.0	4.1	1.8	0.35	3,000	3,000			
154	0.15						6.0	4.1	2.1	0.35	3,000	3,000			
184	0.18						6.0	4.1	2.5	0.35	3,000	3,000			
224	0.22						6.0	4.1	2.9	0.35	3,000	3,000			

周波数に対する許容電流特性/

Characteristics of permissible current to frequency

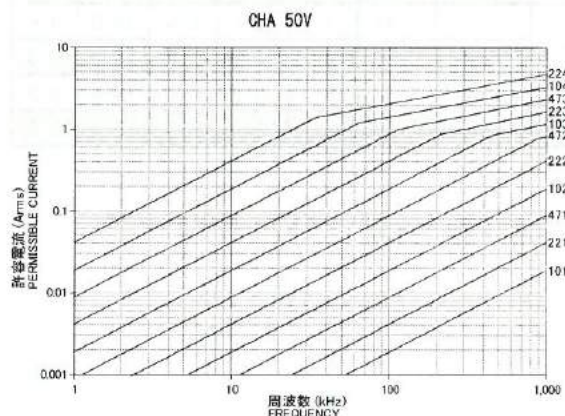
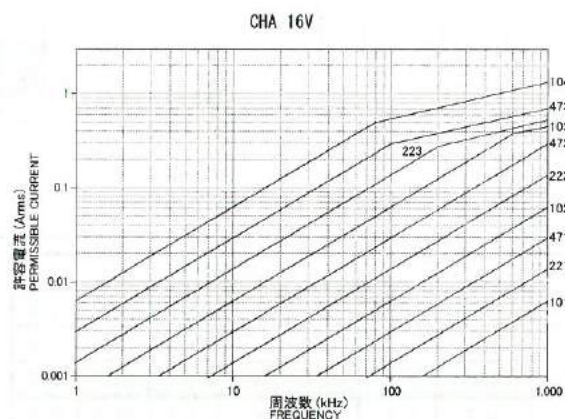

ご使用にあたっては、使用上の注意事項(9-16頁)をご確認の上、技術仕様書等をお求め願ひ、仕様書の範囲内でのご使用をお願いします。 When using our capacitors, please consider the application notes on pages 9-16 and contact NISSEI for any additional technical specifications relating to the limits of our performance characteristics.

特徴/Features

- 小型軽量化されています。
- 難燃性樹脂ケース外装 (UL94 V-0認定品)
- 雑音防止用<アクロスザライン用>

- ★Light and small size.
- ★Flame-retardant case and non combustible resin.
- ★For interference suppression <Across-the-Line>

規格/Specifications

使用温度範囲 Temp. range	-40~+110°C	誘電正接 Tangent of loss angle	0.002 _分 T _{loss} (at 1kHz)
定格電圧 Rated voltage	310Vac	耐電圧 Withstand voltage	端子間 Between terminals: 2000Vdc 2sec. or 1000Vac 60sec.
静電容量範囲 Capacitance	0.010~4.7μF	絶縁抵抗 Insulation resistance	C ≤ 0.33μF 15,000MΩ _分 T _{ore} C > 0.33μF 5,000Ω F _分 T _{ore}
静電容量許容差 Cap. tolerance	±10%(K), ±20%(M)		

安全規格/Safety standard

安全規格 Safety standard	認定番号 File No.	耐候性カテゴリー Climatic category	静電容量範囲 Capacitance	クラス Class
VDE : IEC/EN60384-14	40041628	40/110/56/B	0.01~4.7μF	X2
cUL : UL60384-14 CSA E60384-14	E351313	40/110/56/B	0.01~4.7μF	
CQC : GB/T6346.14	CQC12001079110	40/110/56/B	0.01~4.7μF	
KC : K60384-14	SU03052-11001~11003	40/110/56/B	0.10~1.0μF	

寸法/Dimensions (mm)

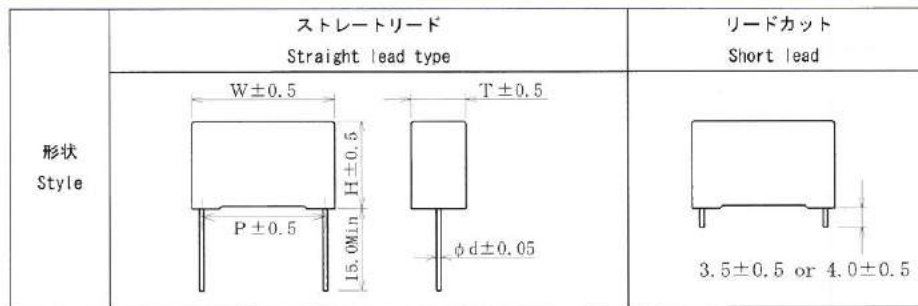

Cap CODE	Cap (μF)	仕様コード MODEL CODE	MP1						基準収納数 NUMBER OF PIECES FOR PACKING UNIT				安全規格 Safety standard
			W	H	T	P	φd	ロング Long		カット Short leads			
								Bag	Box	Bag	Box		
103	0.010	D810	13.0	9.0	4.0	10.0	0.6	200	1,000	200	1,000	VDE, cUL, CQC	
153	0.015	D710	13.0	9.0	4.0	10.0	0.6	200	1,000	200	1,000	VDE, cUL, CQC	
223	0.022	D010	13.0	9.0	4.0	10.0	0.6	200	1,000	200	1,000	VDE, cUL, CQC	
273	0.027	D010	13.0	9.0	4.0	10.0	0.6	200	1,000	200	1,000	VDE, cUL, CQC	
333	0.033	D010	13.0	9.0	4.0	10.0	0.6	200	1,000	200	1,000	VDE, cUL, CQC	
473	0.047	D010	13.0	11.0	5.0	10.0	0.6	200	800	200	800	VDE, cUL, CQC	
683	0.068	D010	13.0	12.0	6.0	10.0	0.6	200	600	200	800	VDE, cUL, CQC	
104	0.10	D010	13.0	12.0	6.0	10.0	0.6	100	500	200	800	VDE, cUL, CQC	
154	0.15	D010	13.0	13.0	7.0	10.0	0.6	100	500	100	500	VDE, cUL, CQC	
224	0.22	D010	13.0	14.0	8.0	10.0	0.6	100	500	100	500	VDE, cUL, CQC	
683	0.068	D015	18.0	10.0	4.0	15.0	0.6	200	800	200	800	VDE, cUL, CQC	
104	0.10	D015	18.0	11.0	5.0	15.0	0.6	100	500	100	700	VDE, cUL, CQC, KC	
154	0.15	D015	18.0	12.0	6.0	15.0	0.6	100	400	100	500	VDE, cUL, CQC, KC	
224	0.22	D015	18.0	13.5	7.5	15.0	0.6	50	300	100	400	VDE, cUL, CQC, KC	
334	0.33	D015	18.0	14.5	8.5	15.0	0.8	50	250	50	300	VDE, cUL, CQC, KC	
394	0.39	D015	18.0	15.5	9.5	15.0	0.8	50	200	50	250	VDE, cUL, CQC	
474	0.47	D015	18.0	16.0	10.0	15.0	0.8	50	200	50	250	VDE, cUL, CQC, KC	
684	0.68	D015	18.0	18.0	11.0	15.0	0.8	25	150	25	150	VDE, cUL, CQC, KC	
105	1.0	D015	18.0	21.0	12.5	15.0	0.8	25	100	25	100	VDE, cUL, CQC, KC	
105	1.0	D022	26.5	22.0	10.0	22.5	0.8	25	100	25	100	VDE, cUL, CQC, KC	
155	1.5	D022	26.5	22.0	12.0	22.5	0.8	25	100	25	100	VDE, cUL, CQC	
225	2.2	D022	26.0	25.0	15.0	22.5	0.8	60	60	60	60	VDE, cUL, CQC	
155	1.5	D027	32.0	22.0	13.0	27.5	0.8	80	80	80	80	VDE, cUL, CQC	
225	2.2	D027	32.0	24.5	15.0	27.5	0.8	60	60	60	60	VDE, cUL, CQC	
335	3.3	D027	32.0	28.0	17.0	27.5	0.8	50	50	50	50	VDE, cUL, CQC	
395	3.9	D027	32.0	33.0	18.0	27.5	0.8	50	50	50	50	VDE, cUL, CQC	
475	4.7	D027	32.0	33.0	18.0	27.5	0.8	50	50	50	50	VDE, cUL, CQC	

ご使用にあたっては、使用上の注意事項(9-16頁)をご確認の上、技術仕様書等をお求め願ひ、仕様書の範囲内でのご使用をお願いします。 When using our capacitors, please consider the application notes on pages 9-16 and contact NISSEI for any additional technical specifications relating to the limits of our performance characteristics.

特徴/Features

- 小型軽量化しております。
- 低うなり音
- 各種スイッチング電源用。

- ★It is smaller and lighter.
- ★Low beat sound
- ★Various SMPS

規格/Specifications

使用温度範囲 Temp. range	-40~85°C (+105°C)*1
定格電圧 Rated voltage	450V, 630Vdc
静電容量 Capacitance	450Vdc 0.47, 1.0 μF 630Vdc 0.47, 2.2 μF
静電容量許容差 Cap. tolerance	±10% (K)
誘電正接 Tangent of loss angle	0.0010 _{10³Hz} (at 1kHz)
耐電圧 Voltage Proof	WV×150% 5 sec
絶縁抵抗 Insulation resistance	7,500 Ω F _{100Vdc} (100V.dc/1 min)

※1 () 温度は電圧軽減による使用可能範囲です。

※1 () Marked temperature shows operatable when voltage is derated.

寸法/Dimensions (mm)

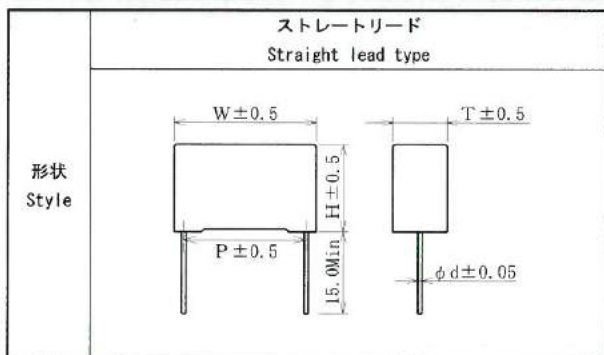

Rated Voltage	Cap. CODE	Cap (μF)	MODEL CODE	Dimension (mm)				
				W	H	T	P	φd
450Vdc	474	0.47	01Z9	13.0	13.0	7.0	10.0	0.6
	105	1.0	01Z9	12.5	15.7	9.0	10.0	0.6
	474	0.47	0000	18.0	12.0	6.0	15.0	0.6
	105	1.0	0000	18.0	13.5	7.5	15.0	0.8
630Vdc	474	0.47	0000	18.0	16.0	10.0	15.0	0.6
	225	2.2	0000	26.5	23.0	14.0	22.5	0.8

個別設計品のため、コンデンサの電圧・電流波形等の使用条件をご確認の上弊社営業までお問い合わせ下さい。

This is a custom-made product. Please contact our sales representatives and inform them of the conditions under which the capacitor will be used, such as voltage and current waveform.

特徴/Features

- 小型軽量化しております。
- 低うなり音
- 各種スイッチング電源用。

- ★It is smaller and lighter.
- ★Low beat sound
- ★Various SMPS

規格/Specifications

使用温度範囲 Temp. range	-40~85°C (+105°C)*1
定格電圧 Rated voltage	450Vdc
静電容量 Capacitance	450Vdc 0.47 ~ 4.7μF
静電容量許容差 Cap. tolerance	±10% (K)
誘電正接 Tangent of loss angle	0.0020 _{max} (at 1kHz)
耐電圧 Voltage Proof	WV×150% 60sec or WV×175% 1~5 sec
絶縁抵抗 Insulation resistance	7,500Ω F _{50Vdc} (100V.dc/1 min)

*1 () 温度は電圧軽減による使用可能範囲です。

*1 () Marked temperature shows operatable when voltage is derated.

寸法/Dimensions (mm)

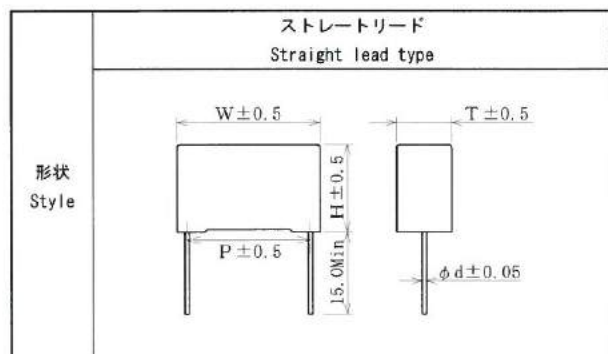

Cap. CODE	Cap (μF)	MODEL CODE	Dimension (mm)				
			W	H	T	P	φ d
474	0.47	01Z9	13.0	11.0	5.0	10.0	0.6
684	0.68	01Z9	13.0	13.0	7.0	10.0	0.6
105	1.0	01Z9	13.0	13.0	7.0	10.0	0.6
105	1.0	0000	18.0	12.0	6.0	15.0	0.6
155	1.5	01Z9	13.0	16.0	8.0	10.0	0.6
155	1.5	0000	18.0	13.5	7.5	15.0	0.6
225	2.2	01Z9	12.5	16.7	9.0	10.0	0.8
225	2.2	0000	18.0	13.5	7.5	15.0	0.8
335	3.3	0000	18.0	15.5	9.5	15.0	0.8
475	4.7	0000	18.0	19.0	11.0	15.0	0.8

個別設計品のため、コンデンサの電圧・電流波形等の使用条件をご確認の上弊社営業までお問い合わせ下さい。

This is a custom-made product. Please contact our sales representatives and inform them of the conditions under which the capacitor will be used, such as voltage and current waveform.

ご使用にあたっては、使用上の注意事項(9-16頁)をご確認の上、技術仕様書等をお求め願ひ、仕様書の範囲内でのご使用をお願いします。

When using our capacitors, please consider the application notes on pages 9-16 and contact NISSEI for any additional technical specifications relating to the limits of our performance characteristics.

特徴 / Features

- 小型軽量・大容量。
- フィルター回路用。

- ★small size, High Capacitance.
- ★Filter circuits.

規格 / Specifications

使用温度範囲 Temp. range	-40~85°C (+105°C)※1
定格電圧 Rated voltage	630, 720Vdc
静電容量 Capacitance	4.5, 10.0μF
静電容量許容差 Cap. tolerance	±10%(K)
誘電正接 Tangent of loss angle	0.0010 _{tanδ} (at 1kHz)
耐電圧 Voltage Proof	WV×150% 1~5sec
絶縁抵抗 Insulation resistance	5,000Ω F _{50°C}

※1 () 温度は電圧軽減による使用可能範囲です。

※1 () Marked temperature shows operatable when voltage is derated.

寸法 / Dimensions (mm)

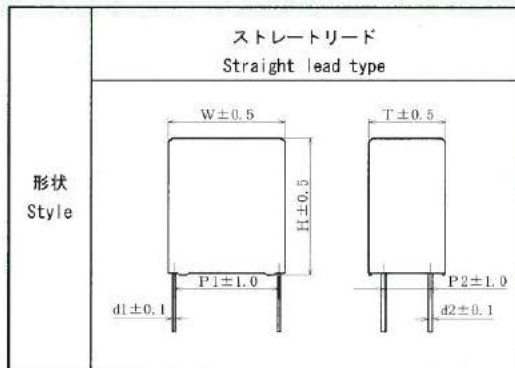

Rated Voltage	Cap. CODE	Cap (μF)	外形寸法 (mm)					
			W	H	T	P1	P2	d1 × d2
630Vdc	455	4.5	26.0	25.0	26.0	22.5	12.0	1.0 × 1.0
720Vdc	106	10.0	32.0	37.0	22.0	27.5	12.7	0.6 × 1.2

個別設計品のため、コンデンサの電圧・電流波形等の使用条件をご確認の上弊社営業までお問い合わせ下さい。
This is a custom-made product. Please contact our sales representatives and inform them of the conditions under which the capacitor will be used, such as voltage and current waveform.

特徴/Features

- 小型軽量・大容量。
- インバーター回路平滑用。

- ★small size, High Capacitance.
- ★Inverter circuit smoothing capacitor.

規格/Specifications

	DLC	DLC (A)	DLC (B)
使用温度範囲 Temp. range	-40~+85°C	-40~+85°C	-40~+85°C
定格電圧 Rated voltage	450, 600Vdc	700~2000Vdc	600~1500Vdc
静電容量 Capacitance	480, 900, 1200 μ F	50~2800 μ F	18~500 μ F
静電容量許容差 Cap. tolerance	$\pm 10\%$ (K)	$\pm 5\%$ (J), $\pm 10\%$ (K)	$\pm 5\%$ (J), $\pm 10\%$ (K)
誘電正接 Tangent of loss angle	0.0020 $\tan \delta_{100}$ (at 100Hz)	0.0020 $\tan \delta_{100}$ (at 100Hz)	0.0020 $\tan \delta_{100}$ (at 100Hz)
耐電圧 Voltage Proof	WV \times 150% 10sec	WV \times 150% 10sec	WV \times 150% 10sec



個別設計品のため、コンデンサの電圧・電流波形等の使用条件をご確認の上
弊社営業までお問い合わせ下さい。
This is a custom-made product. Please contact our sales representatives and inform
them of the conditions under which the capacitor will be used, such as voltage and
current waveform.

使用条件確認 Check sheet for usage conditions

弊社コンデンサをご使用の際、下記項目の条件を確認の上、弊社営業担当へお問い合わせ下さい。
Please contact our sales staff to make sure of the following when you use our capacitors.

品番 Parts number

--

使用条件 Usage condition

下記に記入するか、下記項目の条件が判る波形の提示をお願いします。

Please fill in the table below or provide the waveform that we can confirm the following information.

	定常時 Normal	過渡時 ^{※1} Transition period ^{※1}	異常時 Abnormal
電圧 Voltage	Vo-p	Vo-p	Vo-p
	Vp-p	Vp-p	Vp-p
	Vrms	Vrms	Vrms
電流 Current	Ao-p	Ao-p	Ao-p
	Arms	Arms	Arms
	kHz	kHz	kHz
自己温度上昇 ^{※2} Self temperature rise ^{※2}	℃	℃	℃
周囲温度 Ambient temperature	℃	℃	℃
動作時間および回数 Operation time and number of times			

※1 電源投入時等の定常時と異なる条件

Different conditions compared to the normal, for example, conditions just after power turned on.

※2 製品表面温度 - 周囲温度

Surface temperature of products - Ambient temperature

用途 Application

--

Office and Factories

日精電機株式会社

本社・花巻工場

〒025-0061 岩手県花巻市本館201

TEL 0198-24-7900 FAX 0198-24-7903

NISSEI ELECTRIC CO., LTD.

HEAD OFFICE・Hanamaki Factory

201, Motodate, Hanamaki, Iwate Pref. Japan 025-0061

TEL(+81)198-24-7900 FAX(+81)198-24-7903

岡谷技術研究所

〒394-0005 長野県岡谷市山下町1-21-15

TEL 0266-23-6610 FAX 0266-23-6610

Okaya Technical Center

1-21-15, Yamashita-cho, Okaya, Nagano Pref.

Japan 394-0005

TEL(+81)266-23-6610 FAX(+81)266-23-6610

東日本営業所

〒105-0004 東京都港区新橋6-2-1 木村ビル604号

TEL 03-6459-0452 FAX 03-6459-0453

East Japan Sales Office

No.604, Kimura Building, 6-2-1, Shinbashi, Minato-ku

Tokyo Japan 105-0004

TEL(+81)3-6459-0452 FAX(+81)3-6459-0453

西日本営業所

〒651-0092 兵庫県神戸市中央区生田町1-1-22

ニッシンビル4-B号

TEL 078-414-7177 FAX 078-222-7178

West Japan Sales Office

No.4-B, Nissin Building, 1-1-22, Ikuta-cho, Chuo-ku, Kobe,
Hyogo Pref. Japan 651-0092

TEL(+81)78-414-7177 FAX(+81)78-222-7178

揚州日精電子有限公司

〒225009 中国江蘇省揚州市邗江区高蜀北路68号

TEL(+86)514-8788-3575 FAX(+86)514-8788-2753

YANGZHOU NISSEI ELECTRONICS CO., LTD.

No.68, Gaoshu North Road, Hangjiang District, Yangzhou,
Jiangsu Province, China 225009

TEL(+86)514-8788-3575 FAX(+86)514-8788-2753

上海日精貿易有限公司

〒200127 中国上海市浦東新区東方路1361号海富花園3号楼

G-C座

TEL(+86)21-6873-8400 FAX(+86)21-6482-3702

SHANGHAI NISSEI TRADING CO., LTD.

Suite-G.C, Building 3, Fortune Garden, No.1361, Dongfang
Road, Pudong New Area, Shanghai, China 200127

TEL(+86)21-6873-8400 FAX(+86)21-6482-3702

深圳市日精電氣技術有限公司

〒518112 中国広東省深圳市龍崗区布吉鎮京南華庭B棟1604室

TEL(+86)755-8368-9378 FAX(+86)755-8375-2423

SHENZHEN NISSEI ELECTRONICS CO., LTD.

Room 1604, Building B, Jingnanhuating, Buji Town, Longgang
District, Shenzhen, Guangdong Province, China 518112

TEL(+86)755-8368-9378 FAX(+86)755-8375-2423

日精電子(香港)有限公司

香港灣仔駱克道93-107号利臨大廈13樓1303室

TEL(+852)2528-8583 FAX(+852)2129-6558

NISSEI ELECTRONICS (HONG KONG) CO., LTD.

Unit 1303, 13/F, Beverly House, 93-107 Lockhart Road,
Wanchai, Hong Kong

TEL(+852)2528-8583 FAX(+852)2129-6558