

# General Specifications

## Electrical Capacity (Resistive Load)

**Logic Level:** 0.4VA maximum @ 28V AC/DC maximum  
(Applicable Range 0.1mA ~ 0.1A @ 20mV ~ 28V)  
Note: Find additional explanation of operating range in Supplement section.

## Other Ratings

**Contact Resistance:** 50 milliohms maximum  
**Insulation Resistance:** 500 megohms minimum @ 500V DC  
**Dielectric Strength:** 500V AC minimum for 1 minute minimum  
**Mechanical Life:** 100,000 operations minimum for On-None-On & On-Off-On  
 50,000 operations minimum for other circuits  
 50,000 operations minimum for locking lever models  
**Electrical Life:** 50,000 operations minimum  
**Nominal Operating Force:** Toggles A, A1, E & K with Long Paddle: 1.47N (momentary); 1.18N (maintained)  
 Toggles J & H & K with Short Paddle: 2.72N (momentary); 1.84N (maintained)  
 Toggle L: 0.59N  
**Contact Timing:** Nonshorting (break-before-make)  
**Angle of Throw:** 26°

## Materials & Finishes

**Toggle:** Nickel plated brass  
**Bushing:** Carbon blended polyamide; nickel plated zinc alloy for locking levers & threaded bushing  
**Gasket:** Nitrile butadiene rubber  
**Case Housing:** Glass fiber reinforced polyamide  
**Support Bracket:** Tin plated phosphor bronze  
**Movable Contact:** Phosphor bronze with gold plating  
**Stationary Contacts:** Copper alloy with gold plating  
**Terminals:** Copper alloy with gold plating

## Environmental Data

**Operating Temperature Range:** -30°C through +85°C (-22°F through +185°F)  
**Humidity:** 90 ~ 95% humidity for 96 hours @ 40°C (104°F)  
**Vibration:** 10 ~ 55Hz with peak-to-peak amplitude of 1.5mm traversing the frequency range & returning in 1 minute; 3 right angled directions for 2 hours  
**Shock:** 50G (490m/s<sup>2</sup>) acceleration (tested in 6 right angled directions, with 5 shocks in each direction)

## Installation

**Mounting Torque:** .30 ~ .45Nm (2.65 ~ 3.98 lb•in) for A1 actuator with threaded bushing only

## PCB Processing

**Soldering:** Wave Soldering Recommended: See Profile A in Supplement section.  
 Manual Soldering: See Profile A in Supplement section.  
**Cleaning:** Automated cleaning. See Cleaning specifications in Supplement section.

## Standards & Certifications

**Flammability Standards:** UL94V-0 available  
 The B Series toggles have not been tested for UL recognition or CSA certification.  
 These switches are designed for use in a low-voltage, low-current, logic-level circuit.  
 When used as intended in a logic-level circuit, the results do not produce hazardous energy.

# Distinctive Characteristics

Subminiature size saves space on PC boards.

Specifically developed for logic-level applications.

Antistatic superstructure, consisting of the carbon impregnated bushing and the support bracket, prevents static discharge to the contacts. Static electricity from an operator's touch travels from actuator through the bushing and bracket to the PC board.

Locking lever mechanism offered as a toggle option.

Optional threaded, 6mm diameter bushing for panel seal mounting meets IP65 of IEC60529 specifications (similar to NEMA 4 and 13).

Totally sealed body construction prevents contact contamination and allows time- and money-saving soldering and cleaning. Epoxy sealed terminals lock out flux and other contaminants.

Award-winning STC contact mechanism with benefits unavailable in conventional mechanisms: smoother, positive detent actuation, increased contact stability and unparalleled logic-level reliability. (Additional STC details in Terms & Acronyms; see Supplement section.)

.100" x .100" (2.54mm x 2.54mm) terminal spacing conforms to standard PC board grid spacing.

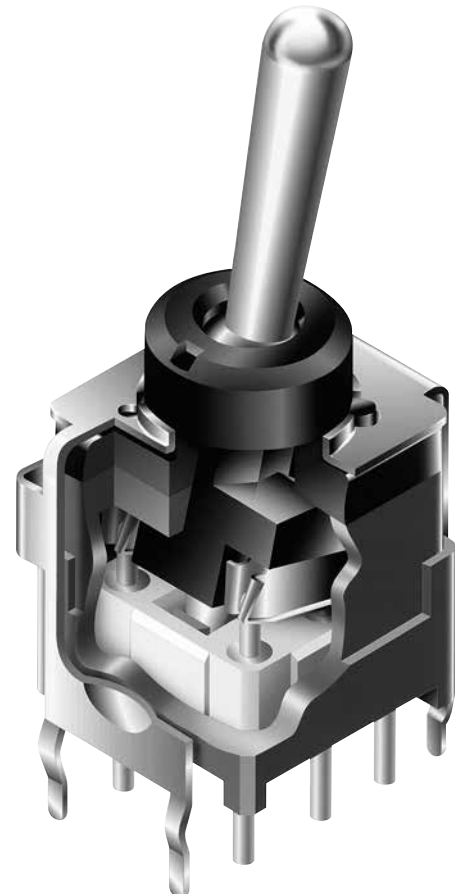

Actual Size

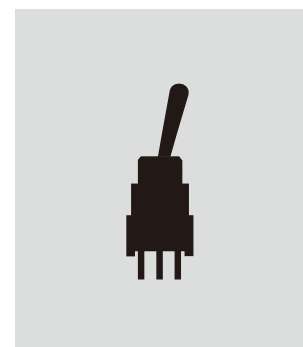

Toggles A  
 Rockers  
 Pushbuttons  
 Illuminated PB  
 Programmable  
 Keylocks  
 Rotaries  
 Slides  
 Tactiles  
 Tilt  
 Touch  
 Indicators  
 Accessories  
 Supplement

### TYPICAL SWITCH ORDERING EXAMPLE

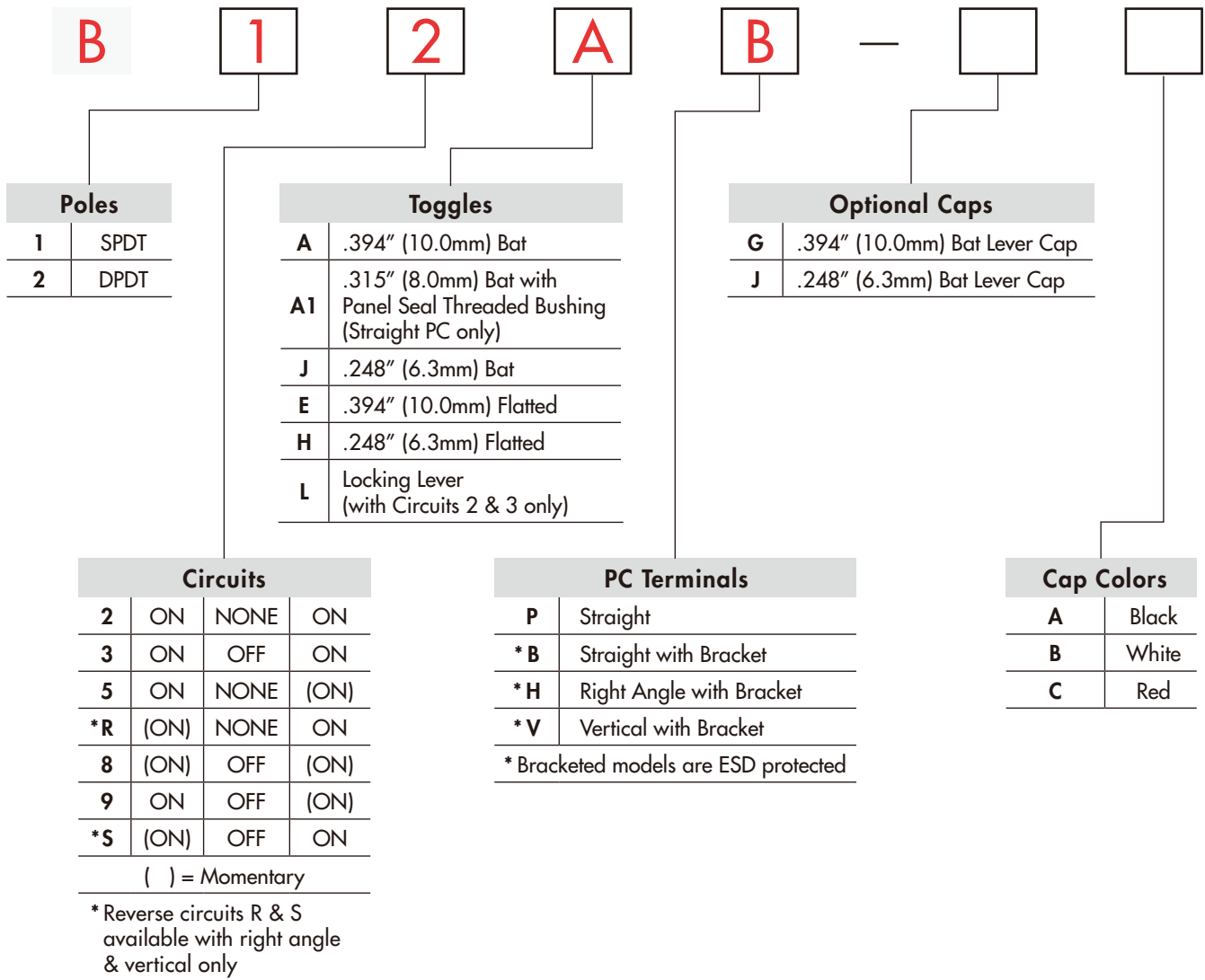

### DESCRIPTION FOR TYPICAL ORDERING EXAMPLE

#### B12AB

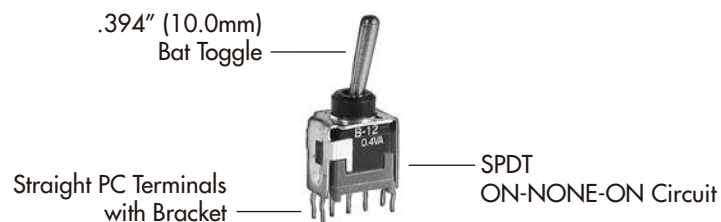

## POLES & CIRCUITS

		Toggle Position ( ) = Momentary			Connected Terminals			Throw & Schematics
Pole	Model	Up	Center	Down	Up	Center	Down	Note: Terminal numbers are not actually on the switch.
SP	B12 B13 B15 B1R B18 B19 B1S	ON ON ON (ON) (ON) ON (ON)	NONE OFF NONE NONE OFF OFF OFF	ON ON (ON) ON (ON) (ON) ON	2-3	OPEN	2-1	SPDT 
DP	B22 B23 B25 B2R B28 B29 B2S	ON ON ON (ON) (ON) ON (ON)	NONE OFF NONE NONE OFF OFF OFF	ON ON (ON) ON (ON) (ON) ON	2-3 5-6	OPEN	2-1 5-4	DPDT 

## TOGGLES

Standard Material & Finish: Brass with Bright Nickel

**A** .394" (10.0mm) Bat

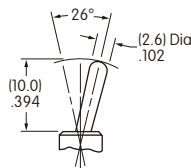

**A1** .315" (8.0mm) Bat with Panel Seal Threaded Bushing

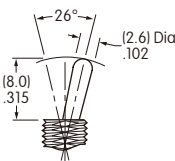

**J** .248" (6.3mm) Bat

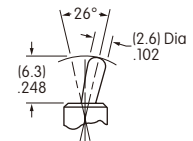

**E** .394" (10.0mm) Flatted

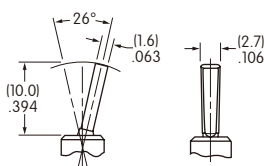

**H** .248" (6.3mm) Flatted

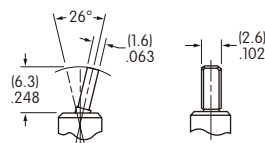

**L** Locking Lever

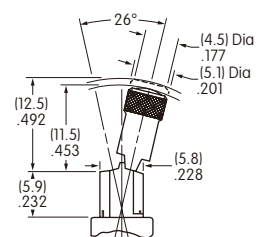

A Toggles  
Rockers  
Pushbuttons  
Illuminated PB  
Programmable  
Keylocks  
Rotaries  
Slides  
Tactiles  
Tilt  
Touch  
Indicators  
Accessories  
Supplement

Toggles A  
 Rockers  
 Pushbuttons  
 Illuminated PB  
 Programmable  
 Keylocks  
 Rotaries  
 Slides  
 Tactiles  
 Tilt  
 Touch  
 Indicators  
 Accessories  
 Supplement

## PC TERMINALS

Use of a support bracket is recommended to increase PCB mounting strength and stability.

### P Straight

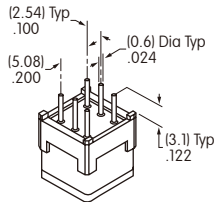

### B Straight with Bracket

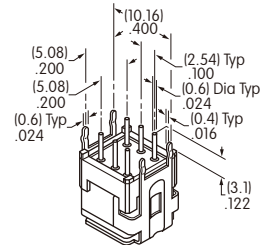

### H Right Angle with Bracket

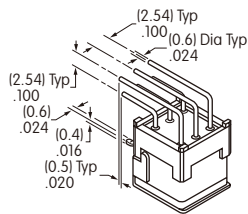

### V Vertical with Bracket

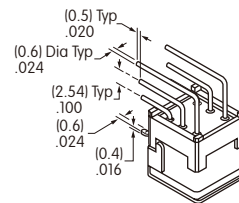

## OPTIONAL CAPS

### G AT4003 .394" (10.0mm) Bat Lever Cap

Material: PVC  
 Colors Available:  
 A, B, C

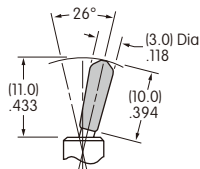

### J AT4064 .248" (6.3mm) Bat Lever Cap

Material: PVC  
 Colors Available:  
 A, B, C

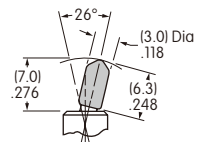

### Color Codes:

**A** Black

**B** White

**C** Red

## TYPICAL SWITCH DIMENSIONS

### Single Pole

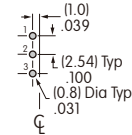
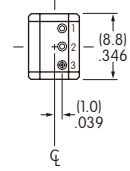
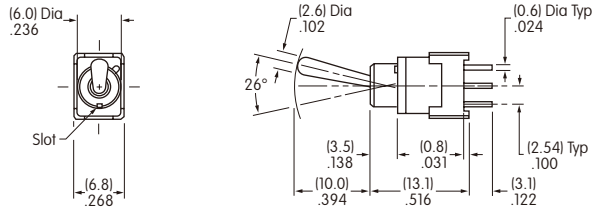

### Straight PC



**B12AP**

### Double Pole

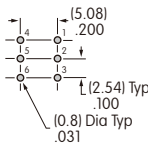
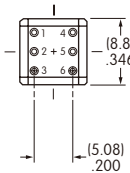
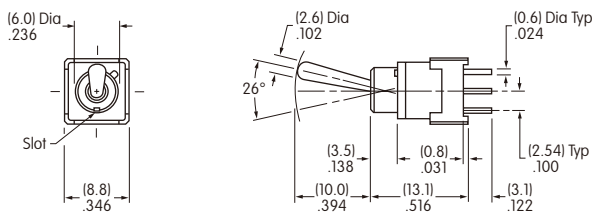

### Straight PC



**B22AP**

### Single Pole

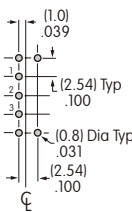
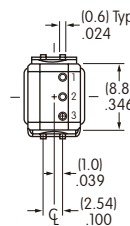
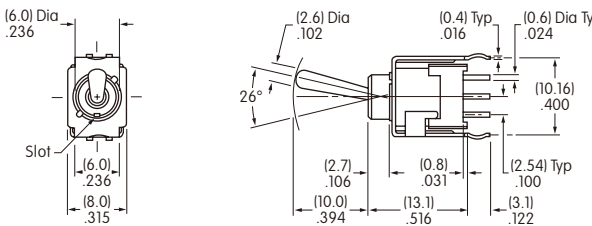

### Straight PC • Bracket



**B12AB**

### Double Pole

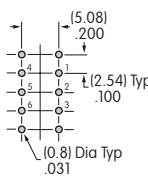
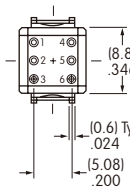
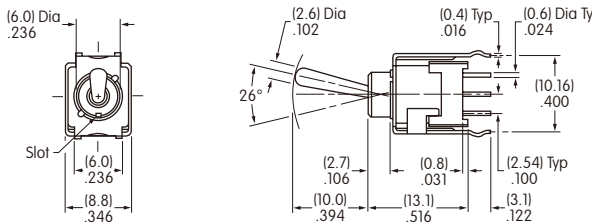

### Straight PC • Bracket



**B22AB**

### Single Pole

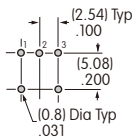
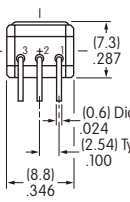
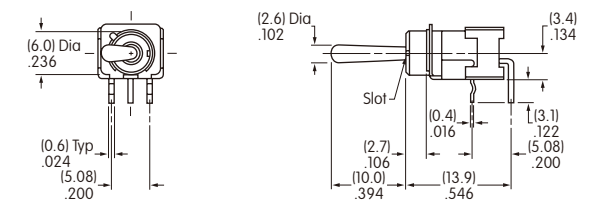

### Right Angle PC



**B12AH**

Toggles

Rockers

Pushbuttons

Programmable Illuminated PB

Keylocks

Rotaries

Slides

Tactiles

Tilt

Touch

Indicators

Accessories

Supplement

## TYPICAL SWITCH DIMENSIONS

### Right Angle PC



**B22AH**

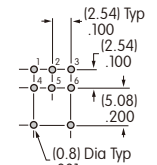
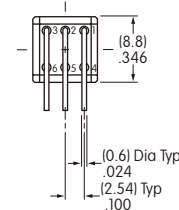
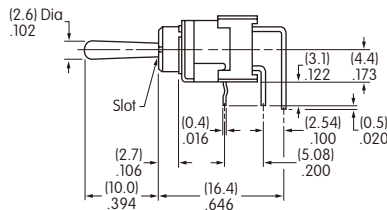
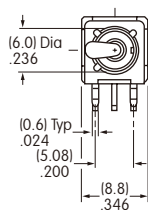

### Double Pole

### Vertical PC



**B12AV**

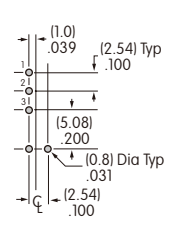
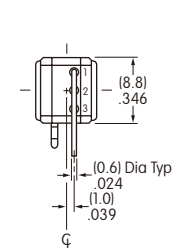
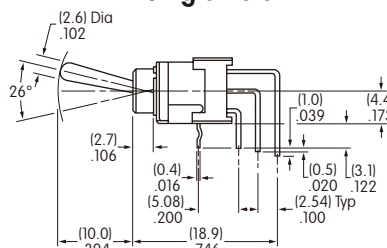
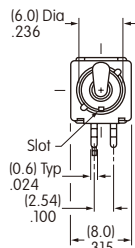

### Single Pole

### Vertical PC



**B22AV**

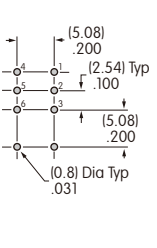
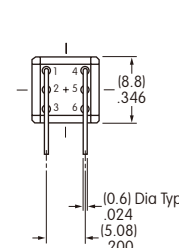
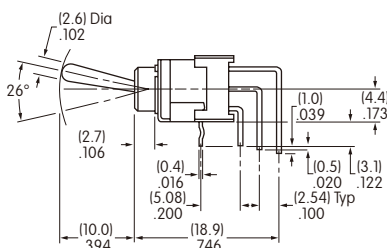
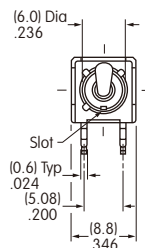

### Double Pole

### Locking Lever • Straight PC • Bracket



**B12LB**

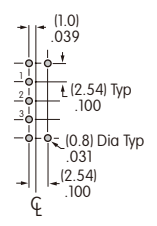
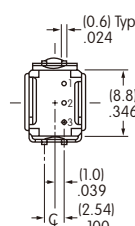
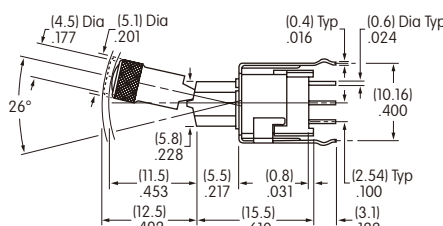
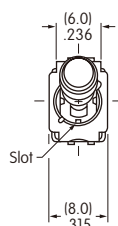

### Single Pole

### Locking Lever • Straight PC • Bracket



**B22LB**

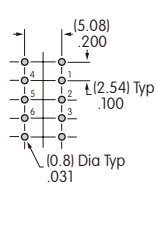
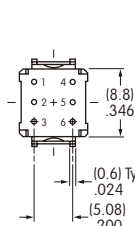
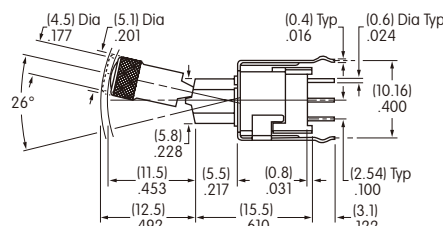
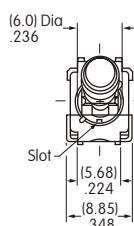

### Double Pole

TYPICAL SWITCH DIMENSIONS

Panel Seal • Single Pole

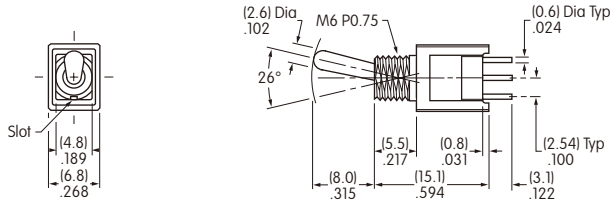

Threaded Bushing • Straight PC

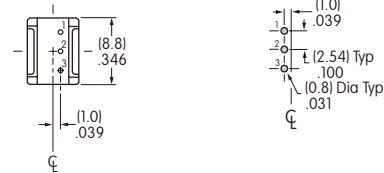

B12A1P

Panel Seal • Double Pole

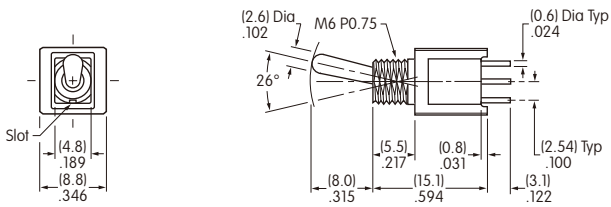

Threaded Bushing • Straight PC

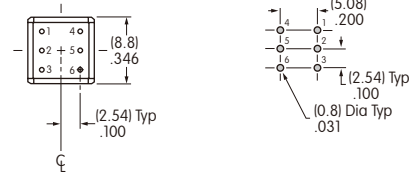

B22A1P

STANDARD HARDWARE & PANEL CUTOUT

AT513M  
Metric Hex Nut

Material:  
Brass,  
Nickel plated

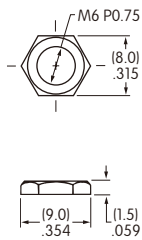

AT063  
Gasket

Material:  
Nitrile butadiene  
rubber

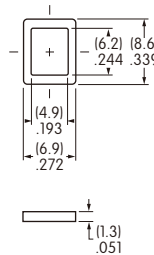

Maximum Panel Thickness  
with Standard Hardware:  
.087" (2.2mm)