

STEPPING SYSTEM

F Series

B S 1 D 2 0 0

INSTRUCTION MANUAL

Since this product does not correspond to the strategic materials specified in the “Foreign Exchange and Foreign Trade Law”, it is unnecessary to apply to the Ministry of International Trade and Industry to export the product. However, since customs may require explanations for non-correspondence, we will send you documents for it on request.

When this product is combined with other machines, be sure to follow their corresponding/non-corresponding judgments.

PREFACE

The F-series “BS1D200 ” achieves a low-vibration and low-noise drive by using a newly developed control system, while retaining the high-speed and high-torque drive of the existing driver series.

This is a new series of stepping motor driving units that uses a bipolar connection system to concretely meet the requirements for the user’s applications.

This instruction manual describes the functions, wiring, installation, operation, maintenance, specifications, etc. for the "BS1D200 ” driver and stepping motor.

Please read this instruction manual carefully before use to get the full performance from the “BS1D200 ” driver, and then operate it correctly.

After reading the instruction manual, store it in a safe place where it can be easily referred to by the operator when necessary.



This instruction manual may refer to “driver” as “driving unit” and “stepping motor” as “motor” in their abbreviated forms.

CONTENTS

0 . SAFETY PRECAUTIONS

0 . 1	Introduction	0 - 2
0 . 2	Product Guarantee	0 - 2
0 . 3	Meaning of Warning Indications	0 - 3
0 . 4	Cautions on Safety	0 - 3

1 . BEFORE OPERATION

1 . 1	Precaution on Unpacking	1 - 2
1 . 2	Confirmation of the Product	1 - 2
1 . 3	Precautions on Operation	1 - 2
1 . 4	How to Read Model Numbers	1 - 4
1.4.1	Model Number of Stepping Motor	1 - 4
1.4.2	Model Number of Driver	1 - 5
1 . 5	Standard Combination	1 - 6
1 . 6	Accessories	1 - 6

2 . FUNCTIONS AND FEATURES

2 . 1	Built-in Functions	2 - 2
2 . 2	Features	2 - 2

3 . SYSTEM CONFIGURATION

3 . 1	Driver Part Names	3 - 2
-------	-------------------	-------

4 . WIRING

4 . 1	Applicable Wire Sizes	4 - 2
4 . 2	Applicable Connector and Conformable Housing/Contact	4 - 2
4.2.1	Photo Coupler Type	4 - 2
4.2.2	C-MOS Type	4 - 2
4 . 3	External Connection Figures	4 - 3
4.3.1	Photo Coupler Type	4 - 3
4.3.2	C-MOS Type	4 - 3
4 . 4	Specification Summary of Input/Output Signals	4 - 4
4 . 5	Wiring Procedure	4 - 4

5 . INSTALLATION

5 . 1	Driver Installation	5 - 2
5.1.1	Installation Place	5 - 2
5.1.2	Installation Procedure	5 - 3
5 . 2	Stepping Motor Installation	5 - 3
5.2.1	Installation Place	5 - 3
5.2.2	Installation Procedure	5 - 4
5 . 3	Lead Wire Installation	5 - 5

6 . OPERATION

6 . 1	Driving Sequence	6 - 2
6.1.1	Power Source ON Sequence	6 - 2
6 . 2	Display	6 - 2
6.2.1	LED Display	6 - 2

7 . SET UP

7 . 1	Overview	7 - 2
7 . 2	Switch Explanation	7 - 2
7.2.1	Function Select Dip Switch	7 - 2
7.2.2	Current Select Switch During Operation (RUN)	7 - 4

8 . MAINTENANCE

8 . 1	Troubleshooting	8 - 2
-------	-----------------	-------	-------

9 . SPECIFICATIONS

9 . 1	Driver	9 - 2
9.1.1	Specifications	9 - 2
9.1.2	Input Interface	9 - 3
9.1.3	Output Interface	9 - 5
9 . 2	Stepping Motor	9 - 6
9.2.1	Common Specifications	9 - 6
9 . 3	External Views	9 - 7
9.4.1	External Views of the Driver	9 - 7

SAFETY PRECAUTIONS [Observe these precautions]

SAFETY PRECAUTIONS

This chapter summarizes the precautions to ensure the safe operation of the F series “BS1D200 ”. Make sure you read this chapter before operation.

0.1	Introduction	0-2
0.2	Product Guarantee	0-2
0.3	Meaning of Warning Indications	0-3
0.4	Cautions on Safety	0-3

SAFETY PRECAUTIONS [Observe these precautions]

0.1 Introduction

The driver and the stepping motor are designed to be used for general industrial equipment. Therefore, note the following precautions.

- To ensure proper operation, read the Instruction Manual carefully before installation, wiring, and operation.
- Do not modify the product.
- For installation or maintenance, consult our dealer or authorized agency.
- When using the product for the following purposes, special measures such as system multiplication or emergency power generator installation should be taken regarding operation, maintenance, and management of the product. In these cases, consult us.
 - Use in medical equipment affecting people's lives.
 - Use in equipment that may lead to physical injury, for example, trains or elevators.
 - Use in a computer system that may be socially or publicly influential.
 - Use in other equipment related to physical safety or equipment that may affect the functions of public facilities.
- For use in an environment subject to vibration, for example, on-vehicle use, consult us.

Make sure you read all parts of this manual before use (installation, operation, maintenance, inspection, etc.) to properly use the equipment and only start using it after completely understanding all aspects, safety information, and precautions relating to the equipment.

Keep this manual handy after reading it.

0.2 Product Guarantee

This product is guaranteed for 1 year after purchase.

However, the following cases fall outside the terms of the guarantee during the guarantee year and a repair fee must be paid.

When a mistake is made during use or when caused by unauthorized repair or modifications

When the fault is caused by something other than the product purchased

When it is used outside the specification values

Additionally, when it is caused by a natural disaster, a disaster, or a secondary disaster

In addition, this guarantee only covers damage done to this product and does not cover any damage caused by this product.

SAFETY PRECAUTIONS [Observe these precautions]













0.3 Meaning of Warning Indications

The following indications are used in this Instruction Manual to indicate points concerning safety. All of the contents of the indications are important, so make sure you observe the indications and their contents at all times.

- There are 4 kinds of safety note ranks as follows.





DANGER	Incorrect operation may result in dangerous situations which may lead to death or serious injury.
CAUTION	Incorrect operation may result in dangerous situations which may lead to medium or slight injury or only material damage.
	Note that some indications marked as CAUTION may lead to serious results depending on the situation.
PROHIBITED	Indicates what should not be done.
COMPULSORY	Indicates what must be done.

- There are 8 kinds of safety note symbol displays as follows.

Type	Example display
 Symbolic indications of danger	 DANGER, INJURY  ELECTRIC SHOCK
 Symbolic indications calling attention 	 CAUTION  FIRE  BURN
 Symbolic indications prohibiting actions	 PROHIBITED  DISASSEMBLING PROHIBITED
 Symbolic indications urging actions	 COMPULSORY

0.4 Cautions on Safety

DANGER













<p>Do not operate the system in an explosive environment.</p> <p> Otherwise you may be injured or a fire may occur.</p>	<p>For the driver's power supply, use a direct voltage supply where the primary and secondary sides have reinforced insulation.</p> <p> Otherwise you may receive an electric shock.</p>
<p>Do not arrange wires or conduct maintenance work or inspection when the wires are live. Make sure you turn the power off more than 5 minutes in advance.</p> <p> Otherwise you may receive an electric shock.</p>	<p>Ask experts to carry out transporting, installing, wiring, operating, maintaining, and inspecting procedures.</p> <p> Otherwise you may be injured or a fire may occur.</p>

DANGER

SAFETY PRECAUTIONS [Observe these precautions]

















<p>During operation, never touch rotating parts of the motor.</p> <p> Otherwise you may be injured.</p>	
--	--

CAUTION

<p>Perform wiring by referring to the wiring schematics or the instruction manual.</p> <p> Otherwise a fire may occur.</p>	<p>As for the cable, do not damage it, do not apply unreasonable stress to it, do not place any heavy objects on it, and do not crush it.</p> <p> Otherwise a fire may occur.</p>
<p>Make sure you read the Instruction Manual before installing, operating, maintaining, or inspecting, and follow the instructions detailed in the manual.</p> <p> Otherwise you may be injured or a fire may occur.</p>	<p>Do not use the motor and the driver outside their specifications.</p> <p> Otherwise you may be injured or material damage may occur.</p>
<p>Do not use the driver or the motor if they are damaged.</p> <p> Otherwise you may be injured or a fire may occur.</p>	<p>Use the driver and the motor in the combination specified.</p> <p> Otherwise a fire or damage may occur.</p>
<p>Note that the driver, the motor, and any peripheral devices are heated to high temperatures.</p> <p> Otherwise you may be burnt if you touch them.</p>	<p>Check which side is up before unpacking.</p> <p> Otherwise you may be injured.</p>
<p>Check that what you have received is the same as your order. Installing the incorrect product may result in injury to you or damage to the product.</p> <p> Otherwise you may be injured or damage may occur.</p>	<p>Do not remove the connector while the power is on.</p> <p> Otherwise material damage may occur.</p>
<p>Do not measure insulation resistance and dielectric strength.</p> <p> Otherwise material damage may occur.</p>	<p>Arrange cables in accordance with the Technical Standard for Electric Facilities and the Extension Rules.</p> <p> Otherwise cables may be burnt and fire may occur.</p>





SAFETY PRECAUTIONS [Observe these precautions]

! CAUTION





<p>Arrange cables correctly and securely.</p> <p> Otherwise material damage may occur.</p>	<p>Do not shock these units badly.</p> <p> Otherwise damage may be caused.</p>
<p>Never install these units where they are exposed to splashes of water, in corrosive or inflammable gas atmospheres, or near combustibles.</p> <p> Otherwise a fire or damage may be caused.</p>	<p>Choose the distances between the driver, the inside surface of the control panel, and other equipment in accordance with the Instruction Manual.</p> <p> Otherwise a fire or damage may be caused.</p>
<p>Make sure you observe the installation direction.</p> <p> Otherwise damage may be caused.</p>	<p>Install them in nonflammable materials such as metal.</p> <p> Otherwise a fire may occur.</p>
<p>While power is being supplied, and for a while after power has been turned off, do not touch the driver's radiating fin or the motor etc. because they are heated to high temperatures.</p> <p> Otherwise you may be burnt.</p>	<p>When the power is restored after a momentary interruption, do not approach the system because it may suddenly start again. (Design the system so that the operator can remain safe even if it does start again.)</p> <p> Otherwise you may be injured.</p>
<p>When any abnormalities occur, stop operating the system at once.</p> <p> Otherwise you may be injured or a fire may occur.</p>	<p>Do not make extreme adjustment changes as these can make system operation unstable.</p> <p> Otherwise you may be injured.</p>
<p>For a trial run, after the operation check, fix the motor status and separate from the mechanical system, then install to the machine.</p> <p> Otherwise you may be injured.</p>	<p>The retention brake is not a shut-down device to safely secure the machine. Set up a shut down device to safely secure it on the machine's side.</p> <p> Otherwise you may be injured.</p>
<p>When an alarm is generated, before driving remove the cause of the alarm after safely securing the machine, and then turn the power supply back on.</p> <p> Otherwise you may be injured.</p>	<p>Check that the power supply specification is normal.</p> <p> Otherwise damage may be caused.</p>
<p>When inspecting and conducting maintenance, note that the driver's radiating fin is heated to a high temperature.</p> <p> Otherwise you may be burnt.</p>	<p>The operating life expectancy of the electrolytic capacitor inside the driver is 5 years, providing that the yearly ambient temperature is 104°F (40°C). It is recommended to be replaced regularly for preventative maintenance. The operating life expectancy of the fuse is 10 years at the yearly ambient temperature of 104°F (40°C). Regular replacement is recommended.</p> <p> Otherwise damage may be caused.</p>

SAFETY PRECAUTIONS [Observe these precautions]





CAUTION

<p>In case of repair, please contact us. If you disassemble these units yourself, they may malfunction.</p> <p> Otherwise damage may be caused.</p>	<p>During transportation be very careful not to drop or turn over these units, or serious dangers may occur.</p> <p> Otherwise you may be injured.</p>
<p>During transportation, do not hold on to the cables or the motor shaft.</p> <p> Otherwise you may be injured or damage may be caused.</p>	<p>Dispose of the driver and the motor as general industrial waste.</p> <p></p>

PROHIBITED

<p>Do not store these units where they are exposed to water, raindrops, hazardous gas, or liquid.</p> <p> Otherwise damage may be caused.</p>	<p>Do not use the motor's built-in retention brake for general braking. The brake may be damaged if used for this kind of braking.</p> <p> Otherwise damage may be caused.</p>
<p>Do not overhaul the system.</p> <p> Otherwise a fire and electric shock may occur.</p>	<p>Do not remove the nameplate.</p> <p></p>

COMPULSORY

<p>Store these units where they are not exposed to direct sunlight and within the specified ranges of temperature and humidity Driver: -20 to +70 ,below 90% RH (no condensation) Motor: -25 to +80 , below 90% RH (no condensation)</p> <p> Otherwise damage may be caused.</p>	<p>When the Driver is stored for a long period (over 3 years as a guide), please contact us. When it is stored for a long time, the capacity of the electrolytic capacitor decreases and a fault may occur.</p> <p> Otherwise damage may be caused.</p>
<p>Install an emergency stop circuit outside the system so that operation can be stopped immediately and the power supply can be shut off.</p> <p> Otherwise there is a danger that it could run out of control, burnout, cause a fire, or cause secondary damage.</p>	<p>Operate the system within the specified ranges of temperature and humidity shown below. Driver temperature: 32°F to 122°F (0°C to +50), Driver humidity: 85% RH or lower (no condensation) Motor temperature: 14°F to 122°F (-10°C to +50°C), Motor humidity: 90% RH or lower (no condensation)</p> <p> Otherwise it may burnout or damage may be caused.</p>

SAFETY PRECAUTIONS [Observe these precautions]

1. BEFORE OPERATION

BEFORE OPERATION

1.1	Precaution on Unpacking	1-2
1.2	Confirmation of the Product	1-2
1.3	Precautions on Operation	1-2
1.4	How to Read Model Numbers	1-4
1.4.1	Model Number of Stepping Motor	1-4
1.4.2	Model Number of Driver	1-5
1.5	Standard Combination	1-6
1.6	Accessories	1-6

1. BEFORE OPERATION

Please operate this system taking the contents of the following descriptions into consideration.

1.1 Precaution on Unpacking

When unpacking the driver, do not touch it if your hand is charged with electricity.

1.2 Confirmation of the Product

Check the following after receiving the product. Contact us if any abnormality is detected.

- Check if the model numbers of the stepping motor and the driver match those of the ones you ordered (the numbers are described after "MODEL" on the main nameplate).
- Check the appearance of the stepping motor and the driver to confirm that they are free from any abnormality such as breakage or lack of parts.
- Check that all screws on the stepping motor and the driver are tightened properly.

1.3 Precautions on Operation

Be careful of the following during operation.

- At installation, do not give shocks to the stepping motor and the driver, otherwise they may break.
- **Confirm the model number of the driver and make sure to use a power supply of:**
Main power supply: 24V DC / 36V ± 1 0 %
Control supply (C-MOS type only): 5V DC ± 5 %
For the power supply, use a direct voltage supply where the primary and secondary sides have reinforced insulation.
If a power supply other than the above is used, an accident may occur.
- Turn the power on and off during maintenance and inspection after the safety (such as the situation of the load) has been completely checked. If the power is turned on or off while the load is being applied, an accident or breakage may occur.
- Never use this product where corrosive (acid, alkali, etc.), flammable, or explosive liquid or gas exists to prevent it from deforming or breaking.
- Never use this product where flammable or explosive liquid or gas exists since the liquid or the gas may be ignited, causing great danger.

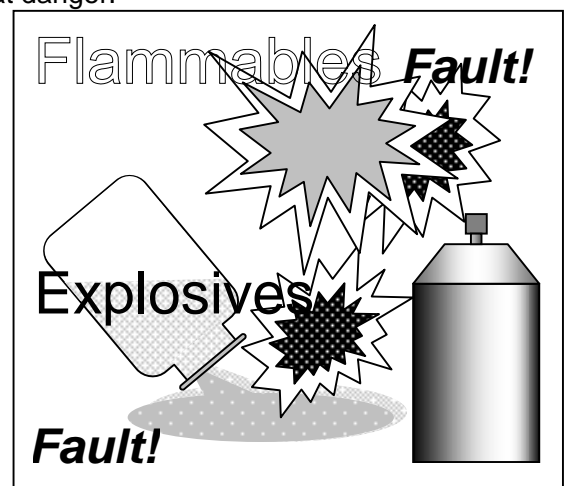
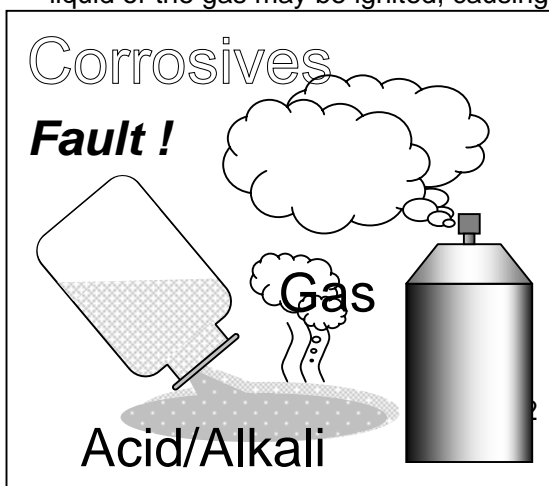

1. BEFORE OPERATION

- Use this product within the ambient temperature range from 32°F to 122°F (14° F to 122°F for the stepping motor) and below the relative humidity limit of 85% (90% limit for the stepping motor).
- The stepping motor and the driver should be kept away from water, cutting fluid, or rainwater. Otherwise electric leakage or electric shock may occur.

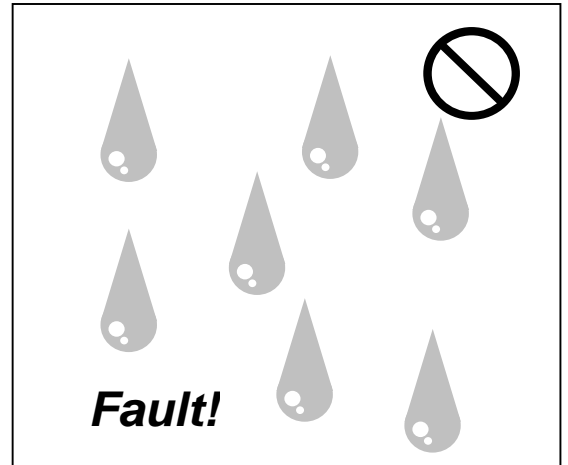
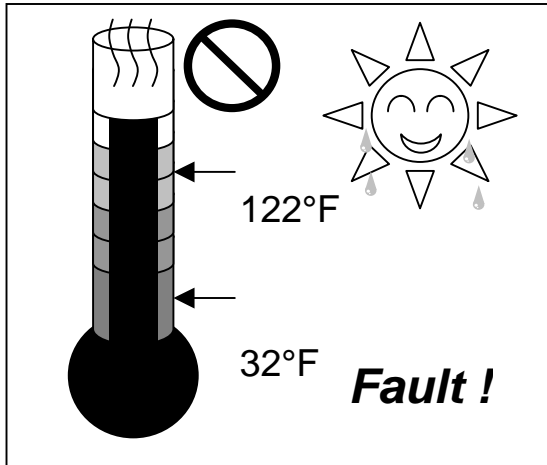

- **Never perform a withstand voltage test or a megger test on the stepping motor or the driver.**
- Refer to “4 Wiring” for details on performing correct wiring. Incorrect wiring may cause a fault to occur.
- For safe operation, make sure you install a surge absorber on the relay, electromagnetic contactor, induction motor, and brake solenoid coils.

1. BEFORE OPERATION

1.4 How to Read Model Numbers

1.4.1 Model Number of Stepping Motor

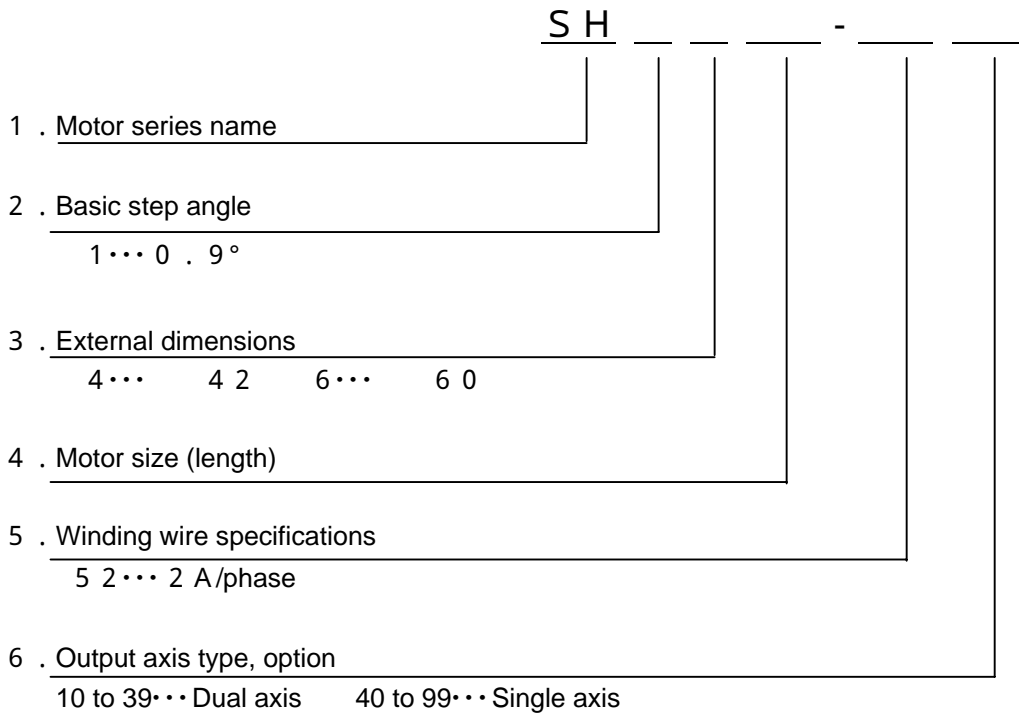
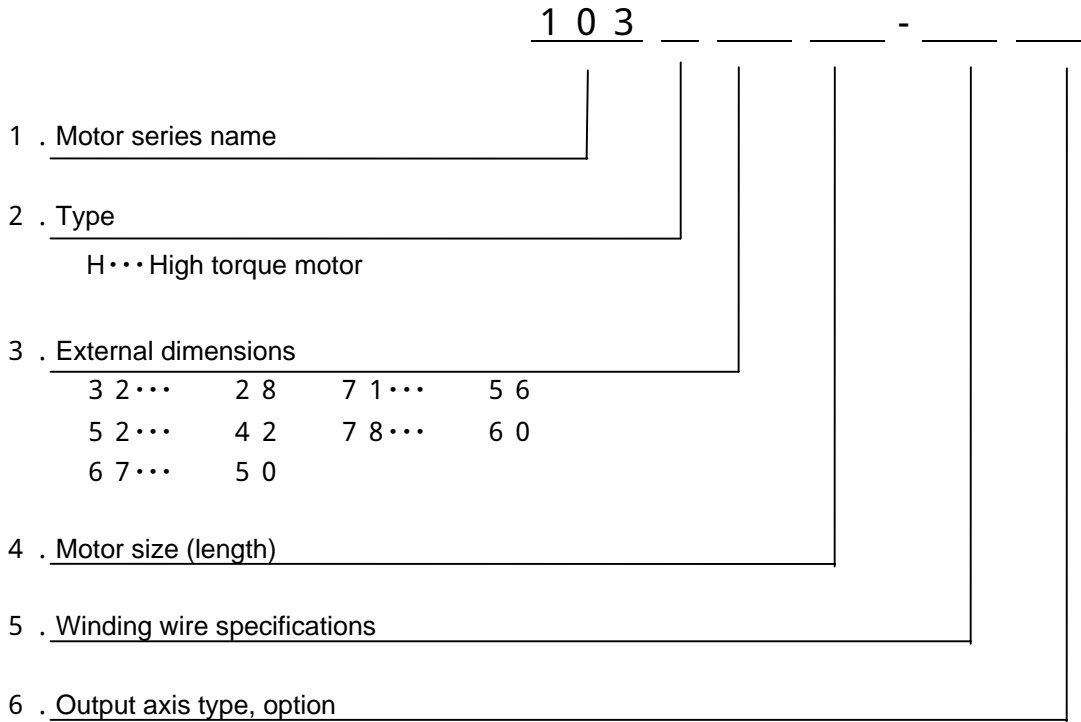

1. BEFORE OPERATION

1.4.2 Model Number of Driver

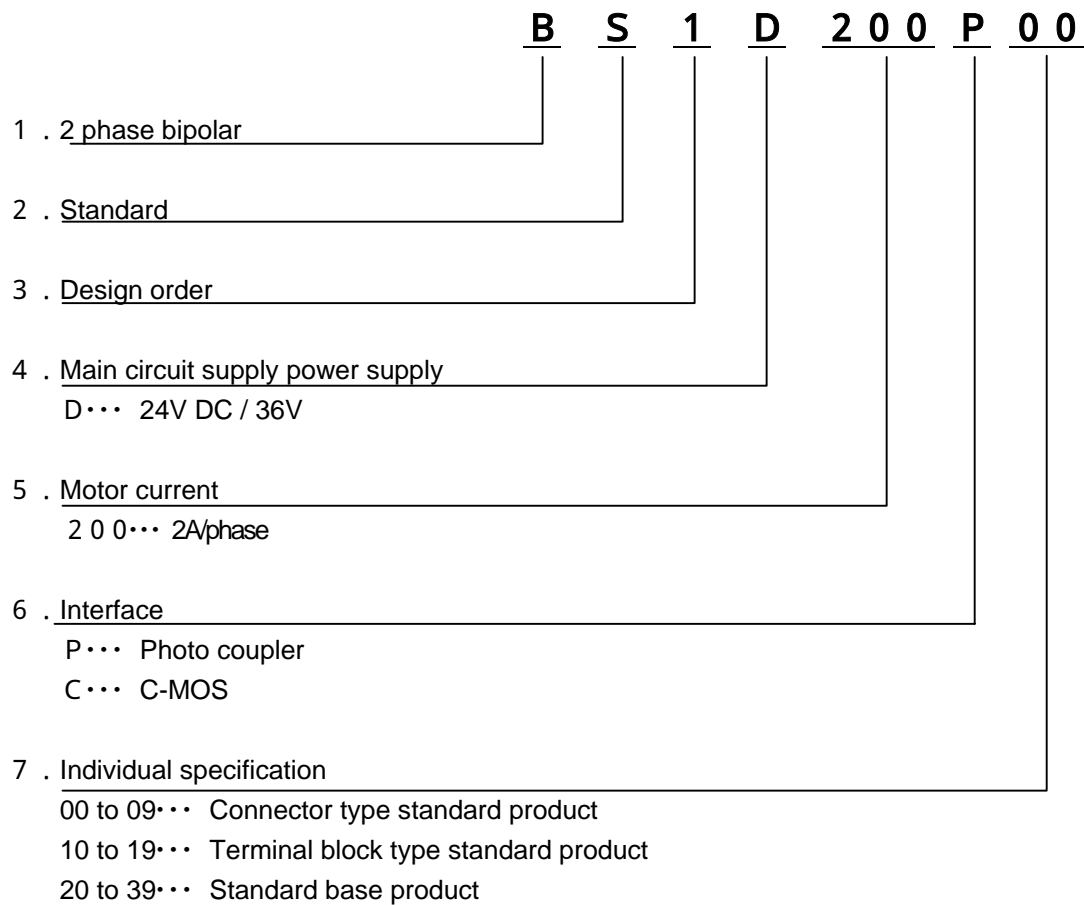

1. BEFORE OPERATION

1.5 Standard Combination

The following shows combinations of stepping motors and drivers.
If the combination is different, it does not drive properly.

Standard combination of F Series “BS1D200 ”

Motor flange size	Single-axis shaft	Dual-axis shaft	Basic step angle	Rated current
28mm	103H3205-5770	103H3205-5730	1.8°	1A
	103H3215-5770	103H3215-5770	1.8°	1A
42mm	103H5205-5240	103H5205-5210	1.8°	1A
	103H5208-5240	103H5208-5210	1.8°	1A
	103H5210-5240	103H5210-5210	1.8°	1A
	SH1421-5241	SH1421-5211	0.9°	2A
	SH1422-5241	SH1422-5211	0.9°	2A
	SH1424-5241	SH1424-5211	0.9°	2A
50mm	103H6701-5040	103H6701-5010	1.8°	2A
	103H6703-5040	103H6703-5010	1.8°	2A
60mm	103H7821-5740	103H7821-5710	1.8°	2A
	103H7822-5740	103H7822-5710	1.8°	2A
	103H7823-5740	103H7823-5710	1.8°	2A
	SH1601-5241	SH1601-5211	0.9°	2A
	SH1602-5241	SH1602-5211	0.9°	2A
	SH1603-5241	SH1603-5211	0.9°	2A

1.6 Accessories

There are no accessory parts for the F Series “BS1D200 ”.

2 . FUNCTIONS AND FEATURES

FUNCTIONS AND FEATURES

2.1	Built-in Functions	2-2
2.2	Features	2-3

2 . FUNCTIONS AND FEATURES

2.1 Built-in Functions

This section explains the driver's main built-in functions.

- **Input pulse mode select function**

By using the dip switch you can select input method 1 or input method 2.

- **Current switch function when driving**

By using the rotary switch, you can set the motor current when driving.

- **Current switch function when stopping**

By using the dip switch, you can set the motor current when stopping.

- **Low vibration mode**

Even for the pulse stream corresponding to Full steps and Half steps it can perform low vibration and smooth driving.

- **Micro step function**

By using the dip switch to set the resolution, micro step driving can be performed.

2 . FUNCTIONS AND FEATURES

2.2 Features

This section explains the driver's features.

- **Interface**

Two kinds of input/output interface, photo coupler and C-MOS, are provided.

- **Wiring method**

As well as the usual connector type, a terminal block type is also provided.

For the terminal block type, you can wire without using any special tools.

3 . FUNCTIONS, FEATURES, AND CONFIGURATION

SYSTEM CONFIGURATION

3.1 Driver Part Names	3-2
-----------------------------	-----

3 . FUNCTIONS, FEATURES, AND CONFIGURATION

3.1 Driver Part Names

Photo coupler input type

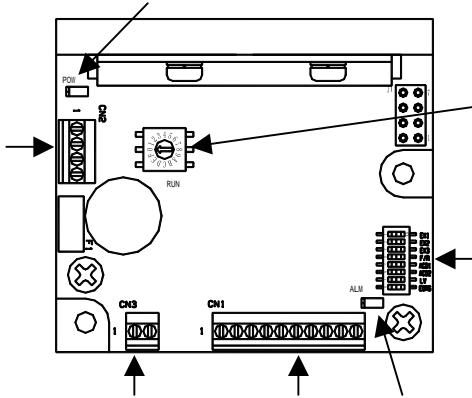

Power supply connector (CN3)

Connect the main circuit power supply.

Input/Output signal connector (CN1)

Connect the input/output signal.

LED for power supply monitor (POW)

Lit up when the main circuit power supply is connected.

Function selection dip switch

You can select functions according to the specifications.

Driving current selection switch (RUN)

You can select the value of the motor current when driving.

LED for alarm display (ALM)

Lit when an alarm is generated.

Motor connector (CN2)

Connect the motor's power line.

C-MOS input type

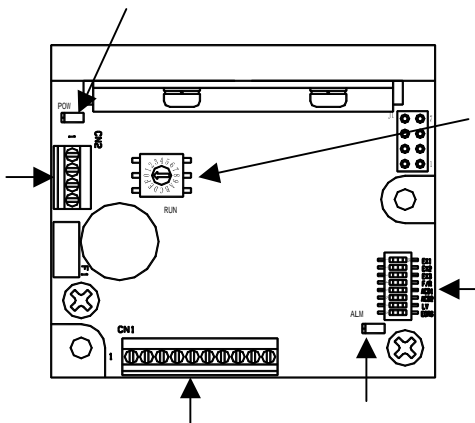

Power supply and input/output signal connector (CN1)

Connect the main circuit power supply, the control Power supply, and the input/output signal.

LED for power supply monitor (POW)

Lit up when the main circuit power supply is connected.

Function selection dip switch

You can select functions according to the specifications.

Driving current selection switch (RUN)

You can select the value of the motor current when driving.

LED for alarm display (ALM)

Lit when an alarm is generated.

Motor connector (CN2)

Connect the motor's power line.

WIRING

4.1	Applicable Wire Sizes	4-2
4.2	Applicable Connector and Conformable Housing/Contact	4-2
4.2.1	Photo Coupler Type	4-2
4.2.2	C-MOS Type	4-2
4.3	External Connection Figures	4-4
4.3.1	Photo Coupler Type	4-4
4.3.2	C-MOS Type	4-4
4.4	Specification Summary of Input/Output Signals	4-5
4.5	Wiring Procedure	4-6

4 . WIRING

4.1 Applicable Wire Sizes

Table 4-1 Applicable Wire Sizes

Part	Wire size	Wire length
For power supply	AWG 22 (0 . 3 mm ²)	2m or less
For input/output signal	AWG 24 (0 . 2 mm ²) to AWG 22 (0 . 3 mm ²)	Photo coupler type: 2m or less C-MOS type: 1m or less
For motor	AWG 22 (0 . 3 mm ²)	Less than 3m



When bundling wires or putting them in a duct, take the allowable current reduction ratio into consideration. When the ambient temperature is too high the life expectancy is shortened due to thermal degradation. In this case, use a heat-resistant vinyl (HIV) cable.

4.2 Applicable Connector and Conformable Housing/Contact

4.2.1 Photo Coupler Type

- Connector wiring method

Name	Driver side	Conformable housing	Conformable contact	Manufacturer
Input/Output signal connector (CN1)	53375-1010	51103-1000	50351-8100	Molex Japan Ltd.
Motor connector (CN2)	53375-0410	51103-0400	50351-8100	Molex Japan Ltd.
Power supply connector (CN3)	53375-0210	51103-0200	50351-8100	Molex Japan Ltd.

For crimping the contact, use Molex Japan Ltd.'s crimping tool: 57295-5000.

- Terminal block method

Name	Driver side	Manufacturer
Input/Output signal connector (CN1)	MPT0.5/10-2.54	Phoenix Contact Ltd.
Motor connector (CN2)	MPT0.5/4-2.54	Phoenix Contact Ltd.
Power supply connector (CN3)	MPT0.5/2-2.54	Phoenix Contact Ltd.

For wiring the terminal block, use a minus head screwdriver with a 0.4×2.0mm blade.

For a stripped wire length of 4.5mm, the tightening torque is 0.12 to 0.15 N · m.

4.2.2 C-MOS Type

- Connector wiring method

Name	Driver side	Conformable housing	Conformable contact	Manufacturer
Power supply and input/output signal connector (CN1)	53375-1010	51103-1000	50351-8100	Molex Japan Ltd.
Motor connector (CN2)	53375-0410	51103-0400	50351-8100	Molex Japan Ltd.

For crimping the contact, use Molex Japan Ltd.'s crimping tool: 57295-5000.

4 . WIRING

• Terminal block method

Name	Driver side	Manufacturer
Power supply and input/output signal connector (CN1)	MPT0.5/10-2.54	Phoenix Contact Ltd.
Motor connector (CN2)	MPT0.5/4-2.54	Phoenix Contact Ltd.

For wiring the terminal block, use a minus head screwdriver with a 0.4×2.0mm blade.

For a stripped wire length of 4.5mm, the tightening torque is 0.12 to 0.15 N · m.



Conformable housing and contact are not included with the driver.

For crimping the contact, use the crimping tool specified by the manufacturer.

4 . WIRING

4.3 External Connection Figures

4.3.1 Photo Coupler Type

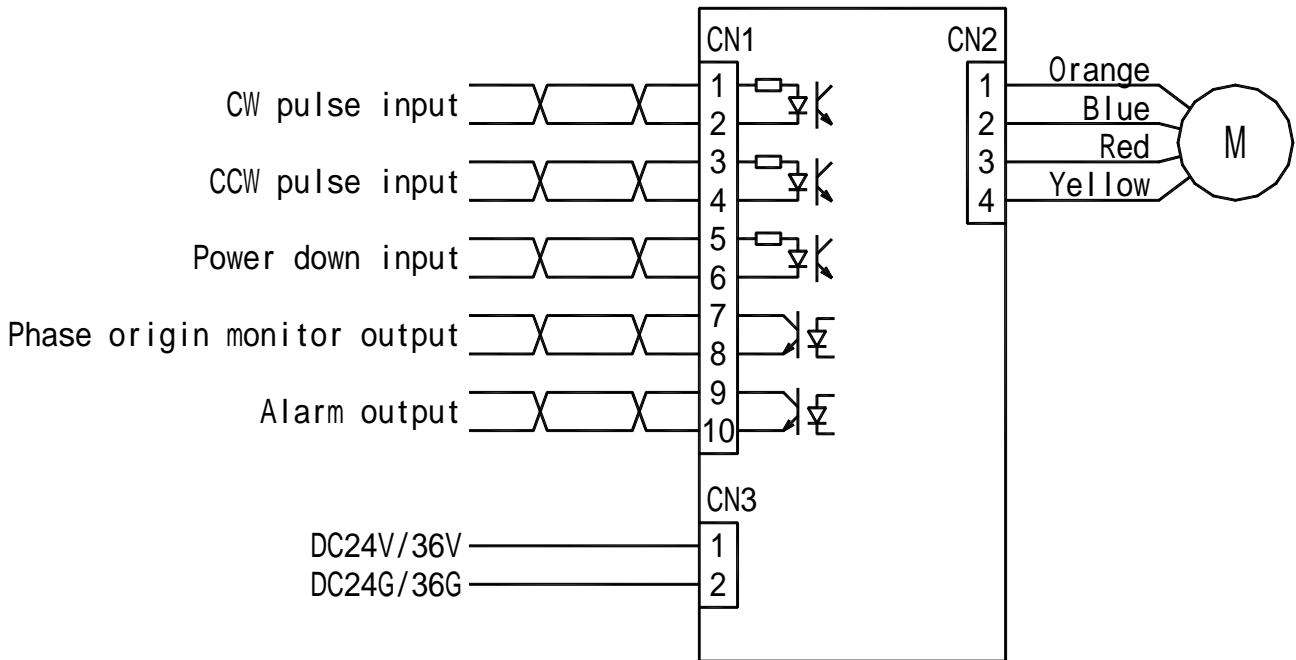

Fig. 4-1 Photo Coupler Type External Connection Figure

4.3.2 C-MOS Type

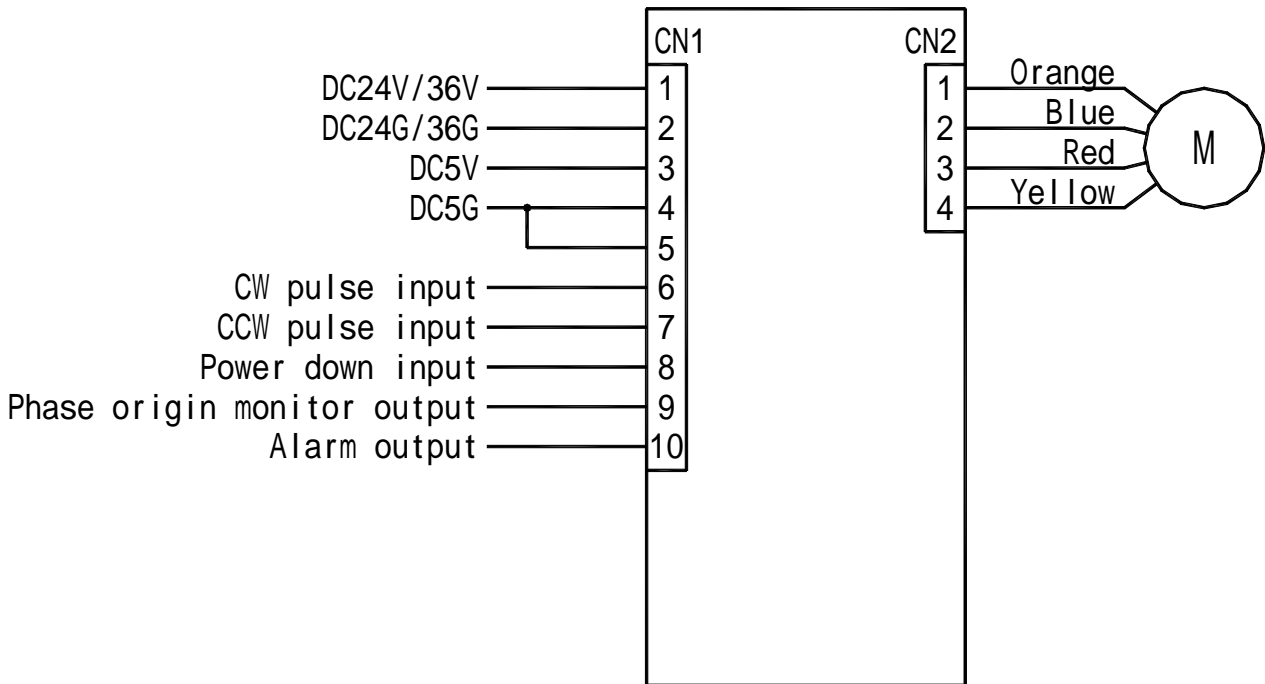

Fig. 4-2 C-MOS Type External Connection Figure

4 . WIRING

4.4 Specification Summary of Input/Output Signals

Table 4-1 CN1 Specification Summary of Input/Output Signals

Signal name	Reference designation	Photo coupler pin number	C-MOS pin number	Function summary
CW pulse input (Standard)	CW	1 2	6	When input method 2 Input drive pulse rotating in a CW direction.
Pulse stream input	CK	1 2	6	When input method 1 Input drive pulse stream for motor rotation.
CCW pulse input (Standard)	CCW	3 4	7	When input method 2 Input drive pulse rotating in a CCW direction.
Rotational direction input	U/D	3 4	7	When input method 1 the rotation direction signal of the motor is input Internal photo coupler ON (C-MOS type is level "H") ... CW direction Internal photo coupler OFF (C-MOS type is level "L") ... CCW direction
Power down input	PD	5 6	8	By inputting a PD signal the current flowing to the motor is cut off. Internal photo coupler ON (C-MOS type is level "L") ... PD function is valid Internal photo coupler OFF (C-MOS type is level "H") ... PD function is invalid
Phase origin monitor output	MON	7 8	9	When the excitation phase is at the origin (in power on) it turns on. When FULL step, ON once for 4 pulses When HALF step, ON once for 8 pulses.
Alarm output	AL	9 10	10	When an alarm circuit is activated inside the driver, an external signal is output. Then the stepping motor becomes an unexcited status.



- 1 . Refer to "9 Specifications" for details on input/output signal specifications.
- 2 . As for the motor's rotational direction, the CW direction is regarded as the clockwise rotation when viewing the motor from the output axis side.

4 . WIRING

4.5 Wiring Procedure

The driver is a control unit that processes signals of several mV or less. Therefore, perform wiring observing the following items.



1 . Input/output signal line

For the input/output signal line, use twisted wires or multi-conductor twisted batch shielded wires.

Wire them by taking the following precautions into account.

- Wire them in the shortest distance
- Separate the main circuit line from the signal circuit line
- Do not wire the main circuit line on the side of the driver or near another driver

2 . Measures to prevent malfunction due to noise

Note the following to prevent malfunction due to noise.

- Arrange the noise filter, the driver, and the upper controller as near as possible
- Make sure you install a surge absorbing circuit on the coils for the relay, the magnetic contactor, the induction motor, and the brake solenoid
- Do not pass the main circuit line and the signal line in the same duct or overlap them
- When a large noise source such as an electric welding machine or an electric discharge machine exists nearby, insert a noise filter into the power supply and the input circuit
- Do not bind the noise filter's primary and secondary side wires together

INSTALLATION

5.1	Driver Installation	5-2
5.1.1	Installation Place	5-2
5.1.2	Installation Procedure	5-3
5.2	Stepping Motor Installation	5-3
5.2.1	Installation Place	5-3
5.2.2	Installation Procedure	5-4
5.3	Lead Wire Installation	5-6

5 . INSTALLATION

5.1 Driver Installation

Refer to the following for the driver's installation place and procedure.

5.1.1 Installation Place

Install the driver by referring to the following.

Case	Precautions
When installing in a box	The temperature in the box may be higher than the outside temperature depending on the power loss of built-in equipment and the dimensions of the box. Make sure you keep the temperature around the driver at 50 (122°F) or lower by properly determining the dimensions of the box, the cooling system, and the arrangement. For a longer lifetime and higher reliability, operate at an in-box temperature of lower than 40°C (104°F) .
When there is a vibration source nearby	Install the driver at the base through a shock absorber so that vibration is not transmitted directly to the driver.
When there is a heat source nearby	Even if there is a possibility that a temperature rise may be caused by convection or radiation, keep the temperature near the driver lower than 50 (122°F).
When there is corrosive gas	If the driver is operated for a long time, contact failure occurs at contact points (e.g., connectors). So, never install the driver in a corrosive gas atmosphere.
When there is explosive gas or combustible gas	Never install the driver in an explosive gas or a combustible gas atmosphere. Relays and contactors, which generate arcs (sparks) inside boxes, and parts such as a regenerative brake resistor may become ignition sources, causing fire and explosion.
When there is dust or oil mist	Never install the driver in an atmosphere containing dust or oil mist. Dust or oil mist adhering to, or accumulating on, the driver may lower insulation or cause leaks between conductors of applicable parts damaging the driver.
When there is a large noise source	Induction noise enters input signals and the power supply circuit, causing a malfunction in the driver. When there is a possibility of noise entering, take proper measures such as inserting a noise filter, revising line wiring, and preventing noise generation.

5 . INSTALLATION

5.1.2 Installation Procedure

Install the driver on a metallic sheet with high heat conductivity.

Use the driver's installation holes and fix it in place either horizontally or vertically with M3 machine screws.

When lining up and installing 2 or more drivers, make sure that they are at least 25mm apart in both horizontal and vertical directions.

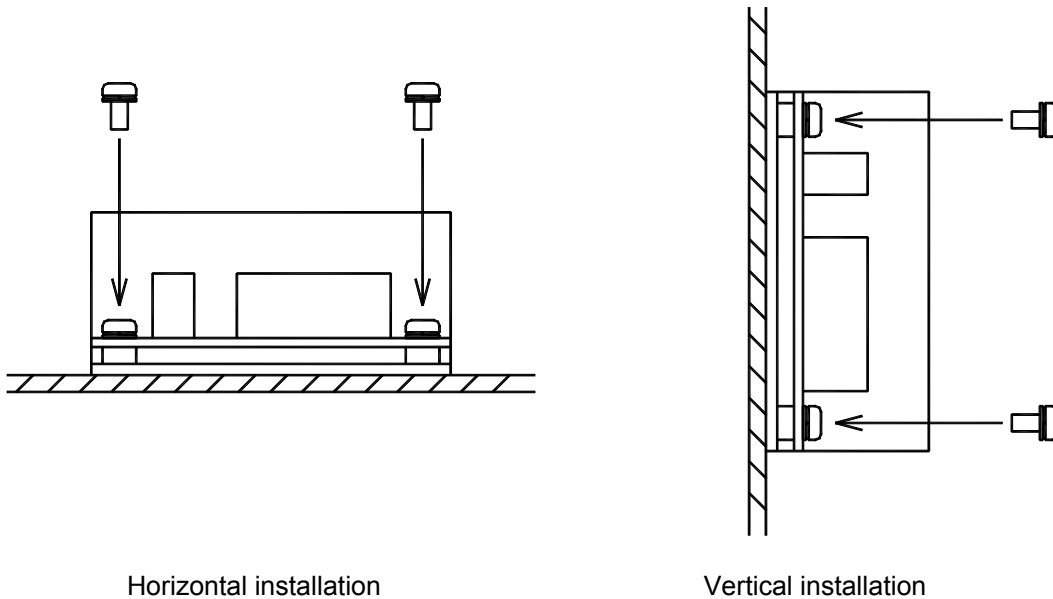

Fig. 5-1

5.2 Stepping Motor Installation

The stepping motor is designed to be installed indoors.

Note the following precautions on the position and method of installation.

5.2.1 Installation Place

Install the stepping motor at an indoor site by referring to the following.

- Ambient temperature : -10 to 50°C (14 ° F to 122 ° F)
- Storage temperature : -25 to 80°C (-13 ° F to 176 ° F)
- Ambient humidity : Less than 90% :Under 40°C Less than 57% :Under 50°C
Less than 35% :Under 60°C (no condensation)
- Storage humidity : 5 to 90% (no condensation)
- Well-ventilated places without corrosive or explosive gas
- Places free from dust or foreign materials
- Places easy to check and clean

5 . INSTALLATION

- Always keep away from oil, water or cut liquid.

5.2.2 Installation Procedure

- Installation Direction
 - The Stepping motor can be installed horizontally or on/under the end of a shaft.
 - When setting vertically, provide a cable trap to prevent oily water from going to the motor.

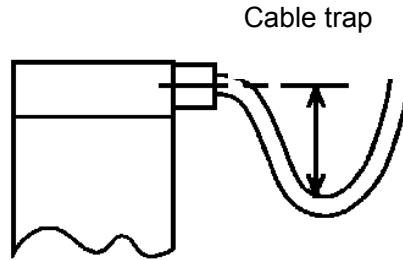

Fig. 5-2

- Prevention against Water

The motor, as a single unit, satisfies the IEC standard. However, since the standard is intended to check performance over a short period of time, measures against wetting are required for actual usage. Handle the system carefully, or the connector sheathes may be hit or damaged, causing the waterproof function to deteriorate.
- Combining with another machine

Perform centering accurately between the motor axis and the other machine. Note that especially when a rigid coupling is used, a slight offset leads to damage of the output axis.

 - When installing the motor to a machine, make a precise installation hole so that the motor joint can be smoothly connected. Also, make the installation surfaces as flat as possible, or the axis or the bearing may be damaged.
 - When installing the gear, the pulley, the coupling, etc., avoid giving shocks to them.

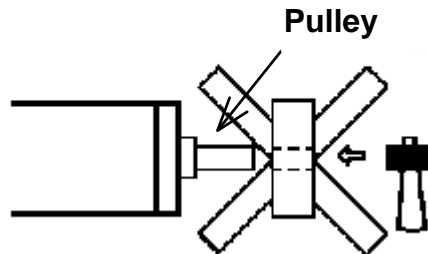

Fig. 5-3

- When removing the gear, the pulley, etc., use a dedicated extracting tool.

5 . INSTALLATION

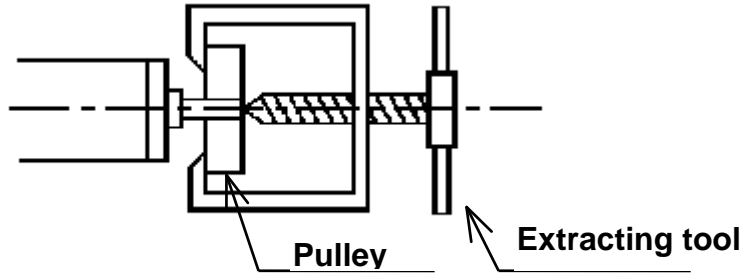

Fig. 5-4

• When performing belt driving, check that the axis-converted value of the belt tension does not exceed the allowable value shown in Table 5-1.

- Allowable Load of Bearing

Table 5-1 shows the load the stepping motor can endure.

Do not apply an excessive thrust or radial load.

The thrust or radial load in the table indicates the value when it is independently applied to the shaft.

Table 5-1 Motor Allowable Radial and Thrust Load

Motor model number	Radial load (N)				Thrust load (N)
	Distance from tip of shaft (mm)				
	0	5	10	15	
1 0 3 H 3 2 5	3 0	3 9	5 3	8 4	3
1 0 3 H 5 2	2 2	2 6	3 3	4 6	1 0
S H 1 4 2					
1 0 3 H 6 7 0	7 1	8 7	1 1 5	1 6 7	1 5
1 0 3 H 7 1 2	5 2	6 5	8 5	1 2 3	1 5
1 0 3 H 7 8 2	7 0	8 7	1 1 4	1 6 5	2 0
S H 1 6 0					

...variable suffixes

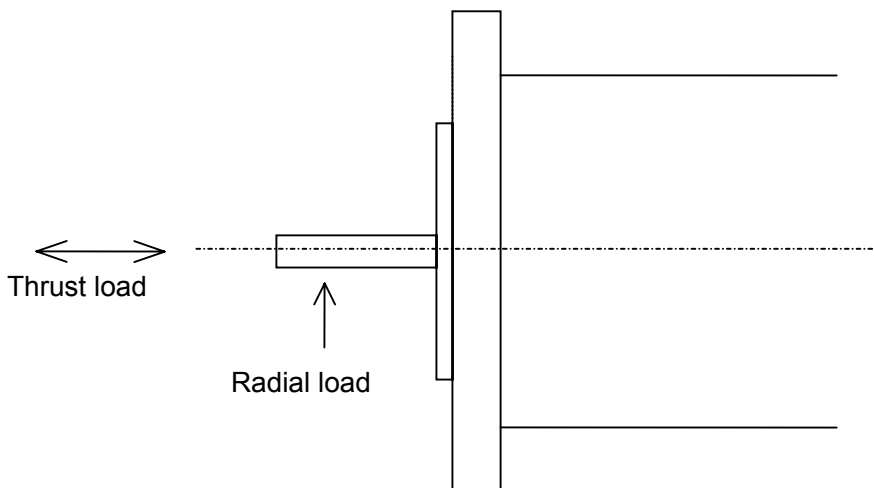

Fig. 5-5 Radial Load/Thrust Load

5 . INSTALLATION

5.3 Lead Wire Installation

- Be careful not to apply any stress or damage to the lead wires.

6. OPERATION

OPERATION

6.1	Driving Sequence	6-2
	6.1.1 Driving Sequence	6-2
6.2	Display	6-3
	6.2.1 LED Display	6-3

6. OPERATION

6.1 Driving Sequence

The frequency of power ON/OFF should be 5 times/H, and 30 times/day or less.

6.1.1 Driving Sequence

- Photo coupler type

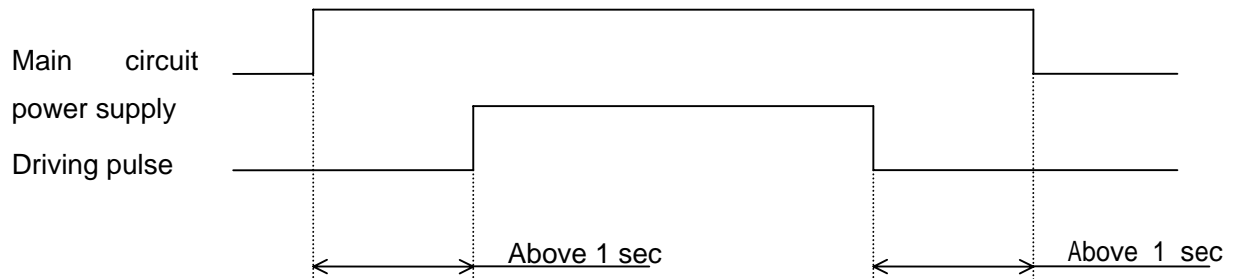

- C-MOS type

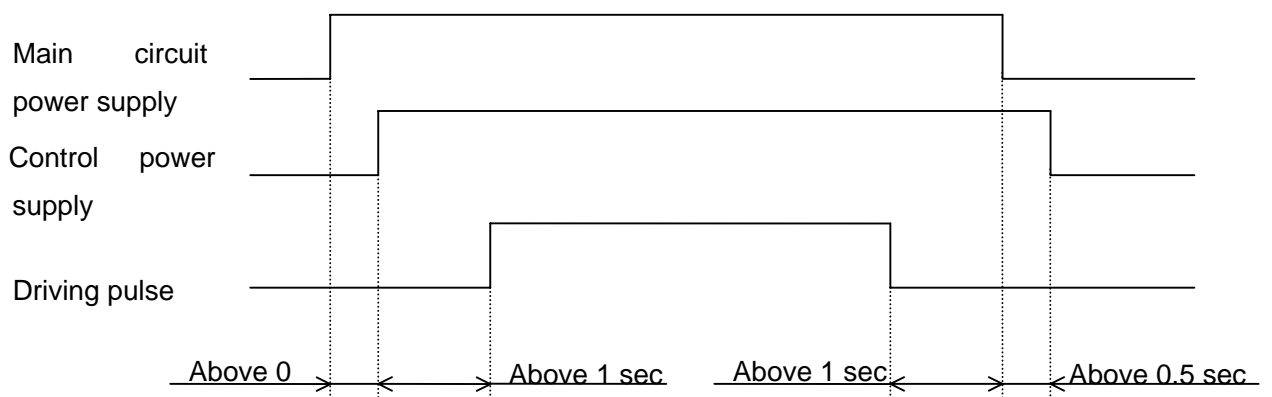

6. OPERATION

6.2 Display

6.2.1 LED Display

Table 6-1 Status Display

Display	Explanation of status
LED "POW" lit	Main circuit power source is connected.
LED "ALM" lit	The motor cable has been disconnected. Or the switching element inside the driver has been damaged. The power supply voltage of a main circuit is DC19V or less.



LED is lit by the alarm circuit operation, and the winding current of the stepping motor is cut off and becomes a state of no excitation.

At the same time, the signal output is also executed from the alarm output terminal (AL) to the external.

This status is maintained when the alarm circuit is operating, and is reset by turning the power supply back on.

When an alarm is generated, make sure you clear the cause of the alarm before turning the power supply back on.

Refer to "8.1 Troubleshooting" for details on clearing the cause of the alarm.

7. SET UP

SET UP

7.1	Overview	7-2
7.2	Switch Explanation	7-2
7.2.1	Function Select Dip Switch	7-2
7.2.2	Current Select Switch During Operation (RUN)	7-4

7. SET UP

7.1 Overview

It is possible to make various settings depending on the specifications by using the rotary and dip switches on the driver's body.

7.2 Switch Explanation

7.2.1 Function Select Dip Switch

Functions can be selected according to the specification with the dip switch.

Check that the ex-factory settings are as follows.

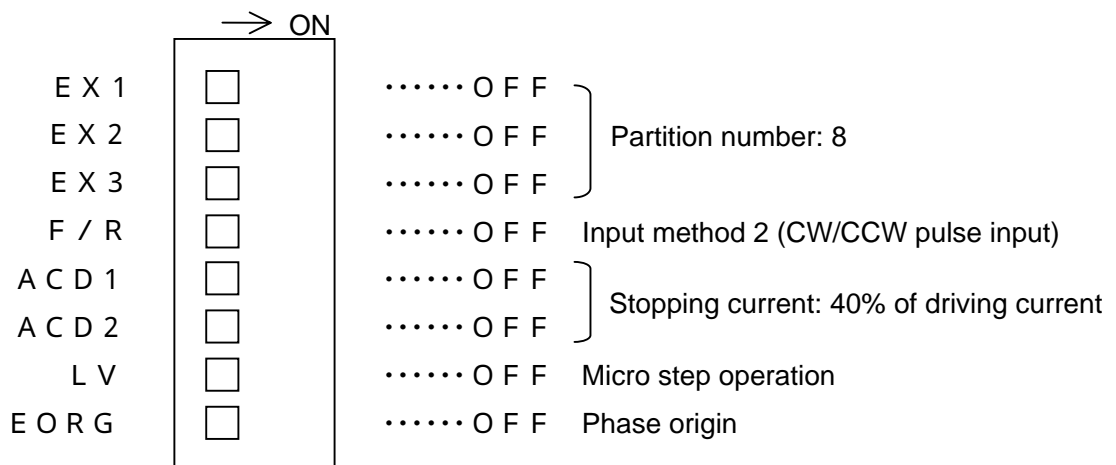

Fig. 7-2 Ex-factory Settings



Cut off the driver's power supply when you change the function select dip switch settings.

Step angle select (EX1, EX2, EX3)

Select the partition number of the basic step angle.

EX 1	EX 2	EX 3	Partition number
ON	ON	ON	1 partition
OFF	ON	OFF	2 partitions
ON	OFF	OFF	4 partitions
OFF	OFF	OFF	8 partitions
OFF	OFF	ON	16 partitions

7. SET UP

Input mode select (F/R)

Select the input pulse mode.

F / R	Input pulse mode
ON	Input method 1 (CK, U/D)
OFF	Input method 2 (CW, CCW)

Current selection when stopping (ACD1, ACD2)

Select the current value of the motor when stopping.

ACD2	ACD1	Motor current
ON	ON	100% of driving current
ON	OFF	60% of driving current
OFF	ON	50% of driving current
OFF	OFF	40% of driving current



When the motor stops (about 200ms after the final pulse is input), the current setting becomes valid while stopping.

The output torque of the motor is nearly proportional to the current value of the motor.

Note the output torque (especially the fall of work etc. of the Z axis load) when the motor stops.

When there is enough of a margin in the output torque of the motor, the rise in heat of the motor and driver can be controlled by lowering the setting for the driving current selection and the stopping current selection.

Low vibration mode select (LV)

Low vibration and smooth operation are enabled even with a rough resolution setting (e.g. 1 partition, 2 partitions).

LV	Initial excitation phase
ON	Low vibration operation
OFF	Micro step operation



When the LV selection is turned ON, to execute the operational process of the driving pulse inside the driver, the motor movement has a delay of one pulse per input pulse.

Note that depending on the combined motor, load, driving profile etc., it may take a while until the shaft is adjusted when the motor stops.

7. SET UP

Excitation select (EORG)

The excitation phase when the power supply is turned on is selected.

E O R G	Initial excitation phase
O N	Excitation phase when power OFF
O F F	Phase origin



By turning on the EORG, excitation phase when power OFF is saved. Therefore, there is no shaft displacement when turning the power ON.

7.2.2 Current Select Switch During Operation (RUN)

The current value of the motor can be selected with this rotary switch.

Gradation	0	1	2	3	4	5	6	7
Motor current	2.0A	1.9A	1.8A	1.7A	1.6A	1.5A	1.4A	1.3A
Gradation	8	9	A	B	C	D	E	F
Motor current	1.2A	1.1A	1.0A	0.9A	0.8A	0.7A	0.6A	0.5A

The ex-factory setting is at "F".

Select the driving current after checking the rated current of the combined motor.



When there is sufficient extra motor torque, lowering the operation current value will be effective to lower vibration. The motor output torque is nearly proportional to the current value. When adjusting the operational torque, confirm there is a sufficient operation margin and determine the motor current value.

8. MAINTENANCE

MAINTENANCE

8.1 Troubleshooting	8-2
---------------------------	-----

8. MAINTENANCE

8.1 Troubleshooting

When the motor does not function normally, check each item in the following table before contacting us.

Table 8-1 Troubleshooting

Trouble	Check items	Corrective actions
The Motor can not be excited.	Has the power supply has been turned ON? Check if "POW" is lit on the LED	After checking the power line connection, turn on the power supply.
	Check the driver status. Is "ALM" lit on the LED?	After checking that the motor cable is disconnected and the connectors are disconnected, turn the power supply on. Set the power supply voltage within the specification range.
	Are there any faulty wirings?	Correct the wirings.
	Is the power down signal being input?	Release the power down input signal.
	If the Motor cannot be excited after the checks and the corrective actions are taken, the driver or the motor may be broken. Confirm that there is no error in the power voltage and the connections, and then execute the repair request.	
The Motor does not rotate.	Is there faulty wiring in the signal line?	Correct the wirings.
	Is the pulse command input within the specification?	Correct the pulse command to within the specified range.
	Is the input signal logic correct in input method 2?	Turn off the input signal for other input terminals where the pulse is not being input.
	Are the CW and CCW signals input at the same time in input method 2?	Correct command input.
	Does the setting by input mode select switch (input method 1/input method 2) match the pulse input mode?	Set the input mode and the pulse input mode to match.
The motor rotation direction is wrong.	Are the CW line and the CCW line reverse connected in input method 2?	Correct the connections
	Are there any mistakes in the motor rotation direction logic command in input method 1?	Correct the command input
	Is there any faulty wiring in the motor lead line?	Correct the wirings

8. MAINTENANCE

Abnormal Motor operation	Are the motor shaft and lead shaft centered accurately?	Correct the centering of the motor shaft and the load shaft.
	Is the distance small or large?	Check the step angle setting Check the input pulse numbers.
Motor power swing	Is the load proper?	Review the load.
	Is the pulse command input properly?	Review the command input.
	Are Slow up/Down performed as designated?	Review Slow up/ Down.
	Are there any stepping motor errors?	Replace the stepping motor.

9. SPECIFICATIONS

SPECIFICATIONS

9.1	Driver	9-2
9.1.1	Specifications	9-2
9.1.2	Input Interface	9-3
9.1.3	Output Interface	9-5
9.2	Stepping Motor	9-6
9.2.1	Common Specifications	9-6
9.3	External Views	9-7
9.3.1	External Views of the Driver	9-7

9. SPECIFICATIONS

9.1 Driver

9.1.1 Specifications

The following table shows the specifications of the Driver.

Table 9-1 Specifications

Model		BS1D200P	BS1D200C		
Main circuit power source		DC24V/36V ± 10%			
Control source		-	DC5V ± 5%		
Main circuit power source current		3A			
Control source current		-	0.5A		
Basic Specification	Environment	Protection class		Class	
		Operating environment		Installation category (over voltage category) : Pollution degree : 2	
		Applicable standard		EN 61010 - 1 , UL 508 C	
		Operating ambient temperature		0 to + 5 0	
		Storage temperature		- 2 0 to + 7 0	
		Operating ambient humidity		3 5 to 8 5 % R H (no condensation)	
		Storage humidity		1 0 to 9 0 % R H (no condensation)	
		Altitude		Up to 2,000 meters above sea level	
		Vibration		4.9m/s ² when tested X,Y and Z directions for 2 hours in the frequency range between 10Hz to 55Hz.	
		Shock		No error based on the section 3.2.2 "C" of the NDS-C-0110 Standard.	
		Dielectric strength		No error when applying 0.5kVAC for a minute between power input terminal and metallic box.	
		Insulation resistor		10M or more with 500 VDC megger between power input terminal and metallic box, over.	
		Mass (g)		90	
Function	Select function	Step angle, Pulse input mode, Stop current, Operating current			
	Protective function	Open phase protection			
	LED display	Power supply monitor, alarm display			
Input/Output signal	Command pulse input signal	Photo coupler input type Input resistance 220 Input signal voltage "H" level: 4.0 to 5.5V "L" level: 0 to 0.5V	C-MOS input type Input signal voltage "H" level: 4.0 to 5.5V "L" level: 0 to 0.5V		
	Power down input signal	Photo coupler input type Input resistance 220 Input signal voltage "H" level: 4.0 to 5.5V "L" level: 0 to 0.5V	C-MOS input type Input signal voltage "H" level: 4.0 to 5.5V "L" level: 0 to 0.5V		
	Phase origin monitor output signal	Open collector output by photo coupler Output signal standard V _{ceo} : 40V I _c : 10mA	Open collector output by transistor Output signal standard V _{ceo} : 40V I _c : 10mA		
	Alarm output signal	Open collector output by photo coupler Output signal standard V _{ceo} : 40V I _c : 10mA	Open collector output by transistor Output signal standard V _{ceo} : 40V I _c : 10mA		

9. SPECIFICATIONS

9. SPECIFICATIONS

9.1.2 Input Interface

Input circuit configuration (C W、 C C W)

Fig. 9-1 shows input circuit configuration.

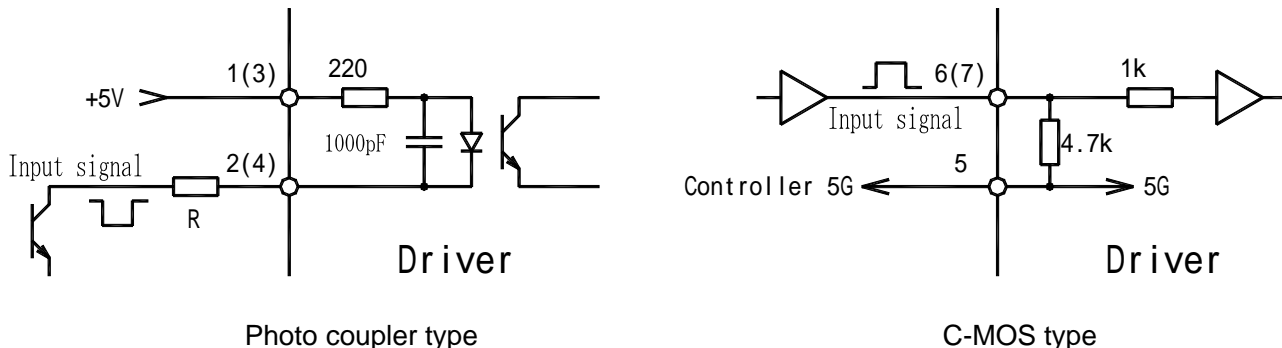

Fig. 9-1 Input Circuit Configuration



Pulse duty 50% MAX.

Maximum input frequency: 150kpulse/s

When the crest value of the input signal exceeds 5V, use the external limit resistance

R to limit the input current to approximately 15mA.

Input signal specifications

Fig.2 shows input signal specifications.

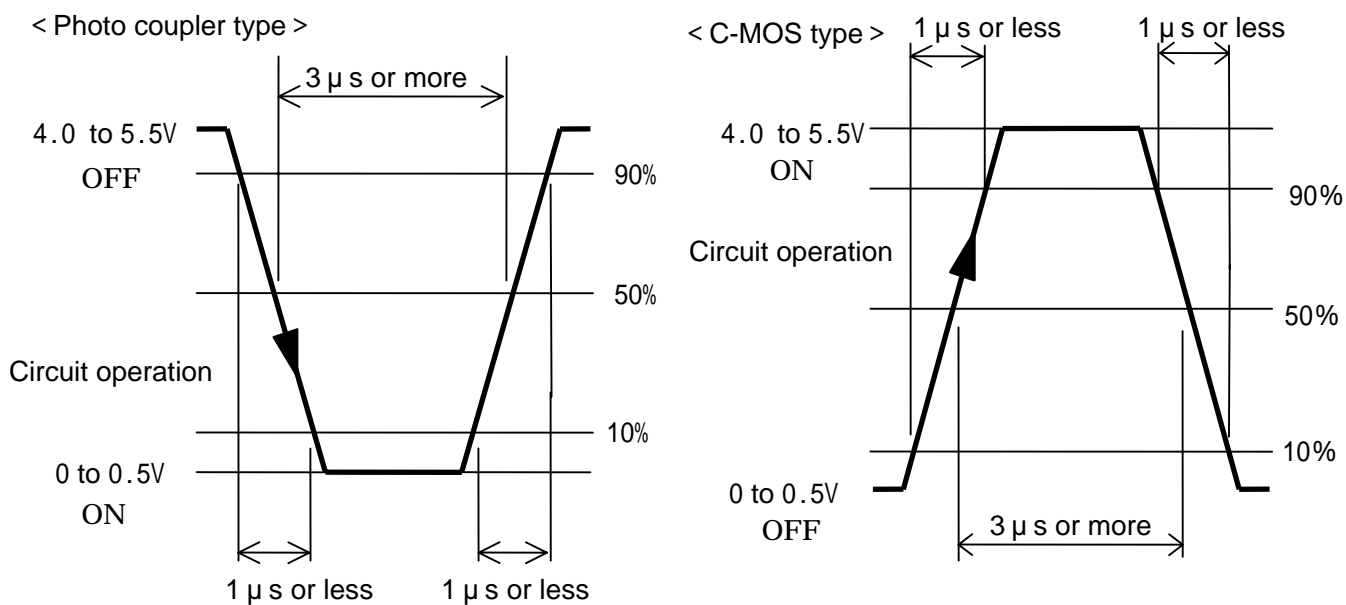

Fig.9-2 Input Signal Specification

9. SPECIFICATIONS

Command pulse timing

2 input mode (C W pulse, C C W pulse)

Fig.9-3 shows command pulse timing when “2 input mode”.

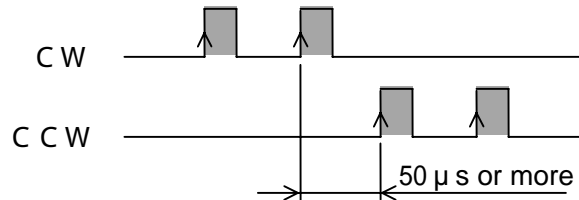

Fig. 9-3 Input Pulse Timing in the “2 Input Mode”



1. The internal circuit (Motor) will be actuated at the leading edge of the pulse.
2. When applying pulse to CW, turn off the CCW.
3. When applying pulse to CCW, turn off the CW.

1 input mode (C K、 U / D)

Fig.9-4 shows command pulse timing when “1 input mode”.

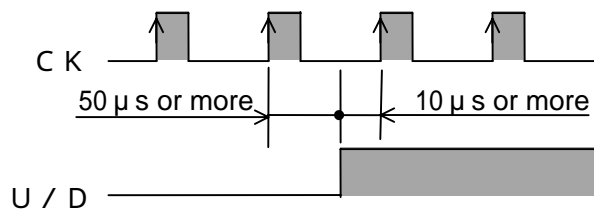

Fig. 9-4 Input Pulse Timing in the “1 Input Mode”



1. The internal circuit (Motor) will be actuated at the leading edge of the CK .
2. Switch the U / D input signal when the CK is OFF.

9. SPECIFICATIONS

Input circuit configuration (P D)

Fig.9-5 shows the input circuit configuration.

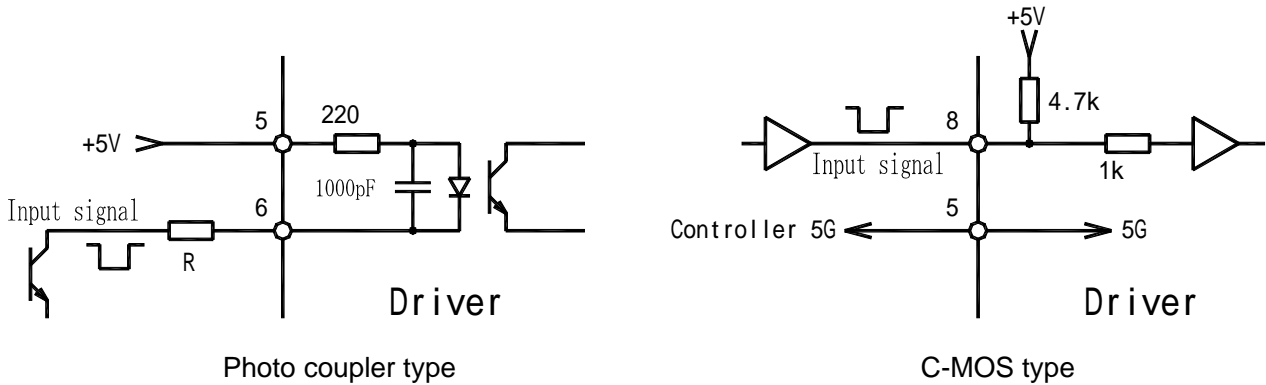

Fig. 9-5 Input Circuit Configuration



When the crest value of the input signal exceeds 5V, use the external limit resistance R to limit the input current to approximately 15mA.

9.1.3 Output Interface

Output circuit configuration (M O N , A L)

Fig.9-7 shows the output circuit configuration.

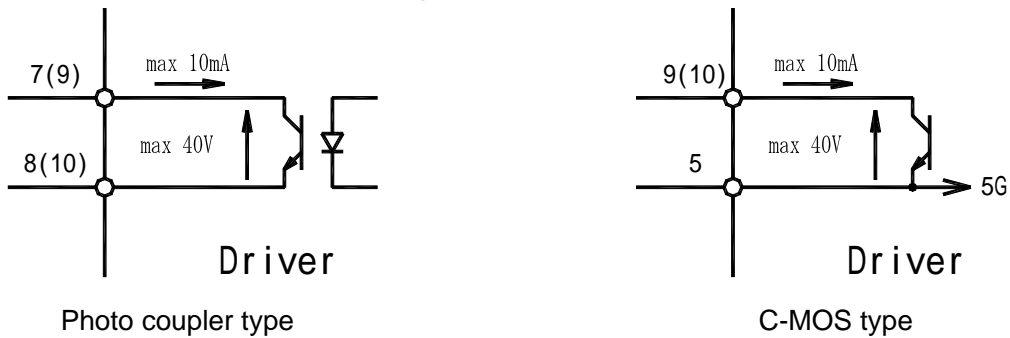

Fig. 9-7 Output Circuit Configuration

MON output

Fig.9-8 shows the “Command pulse and phase origin monitor output signal” timing.

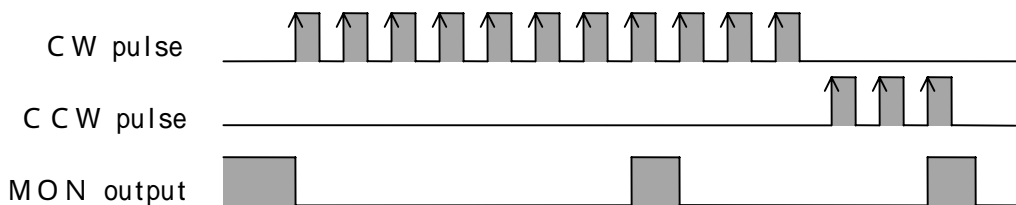

Fig. 9-8 Input Pulse and MON Output Signal Timing (at 2 division setting)



- 1 . When the Motor exciting phase is at the phase origin (power ON status), photo coupler(transistor) is turned on.
- 2 . MON output signal is outputted per Motor output shaft angle of 7.2 ° from phase origin.

9. SPECIFICATIONS

9.2 Stepping Motor

9.2.1 Common Specification

The following table shows stepping motor specifications.

Table 9-2 Common Specifications

Stepping Motor Type	H Series
Model name	103H32XX/103H52XX/103H67XX/103H71XX/103H78XX
Insulation class	Class B(130)
Dielectric strength	28· 42:AC500V 50/60Hz for 1 minute 50· 56· 60:AC1000V 50/60Hz for 1 minute
Insulation resistance	500VDC 100M or more
Vibration resistance	Amplitude: 1.52mm(P-P),147m/s ² , frequency range: 10 to 500Hz, sweep time: 5 minutes, Number of sweep is 12 times each in the X,Y and Z directions
Shock resistance	Acceleration: 98m/s, holding time: 11ms, half-wave sine wave 3 times in each direction of X, Y and Z axes, 18 times in total
Operating ambient temperature	14 to 122 ° F(-10 to 50)
Operating ambient humidity	90%RH(less than 104 ° F (40)) 57%RH(less than 122 ° F (50)) 35%RH(less than 140 ° F (60)) (no condensation)

X···variable suffixes

Stepping Motor Type	S H Series
Model name	SH14XX/SH16XX
Insulation class	Class B(130)
Dielectric strength	42:AC500V 50/60Hz for 1 minute 60:AC1000V 50/60Hz for 1 minute
Insulation resistance	500VDC 100M or more
Vibration resistance	Amplitude: 1.52mm(P-P),147m/s ² , frequency range: 10 to 500Hz, sweep time: 5 minutes, Number of sweep is 12 times each in the X,Y and Z directions
Shock resistance	Acceleration: 98m/s, holding time: 11ms, half-wave sine wave 3 times in each direction of X, Y and Z axes, 18 times in total
Operating ambient temperature	14 to 122 ° F(-10 to 50)
Operating ambient humidity	90%RH(less than 104 ° F (40)) 57%RH(less than 122 ° F (50)) 35%RH(less than 140 ° F (60)) (no condensation)

9. SPECIFICATIONS

9.3 External Views

9.3.1 External Views of the Driver

BS1D200P0

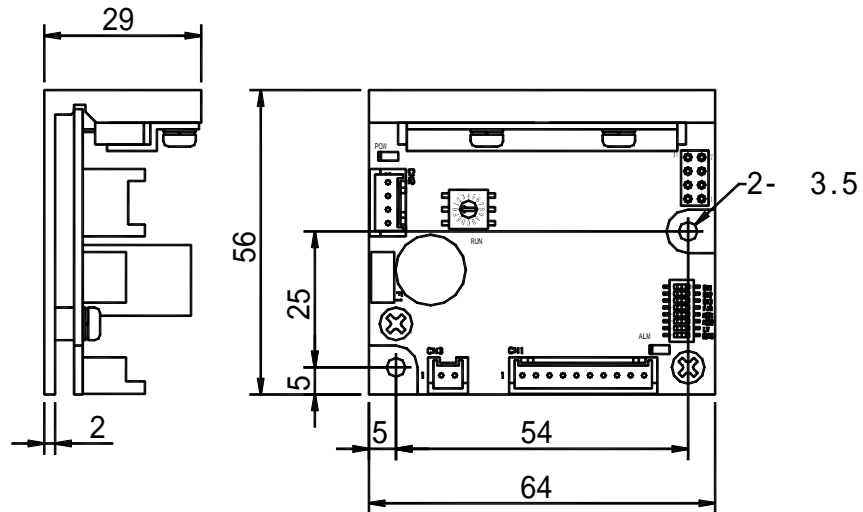

BS1D200C0

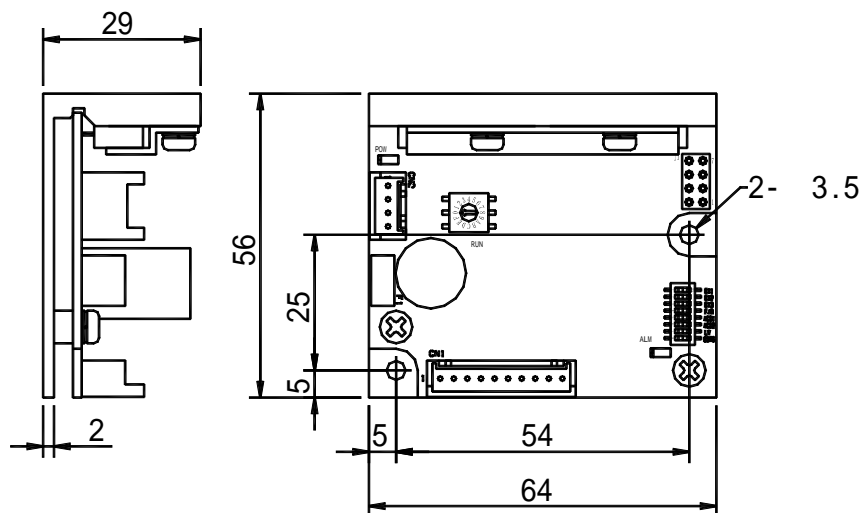

9. SPECIFICATIONS

BS1D200P1

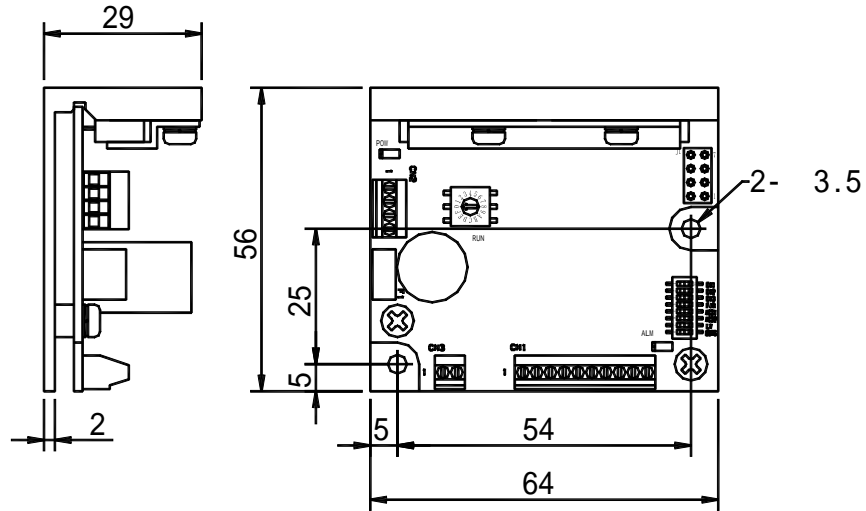

BS1D200C1

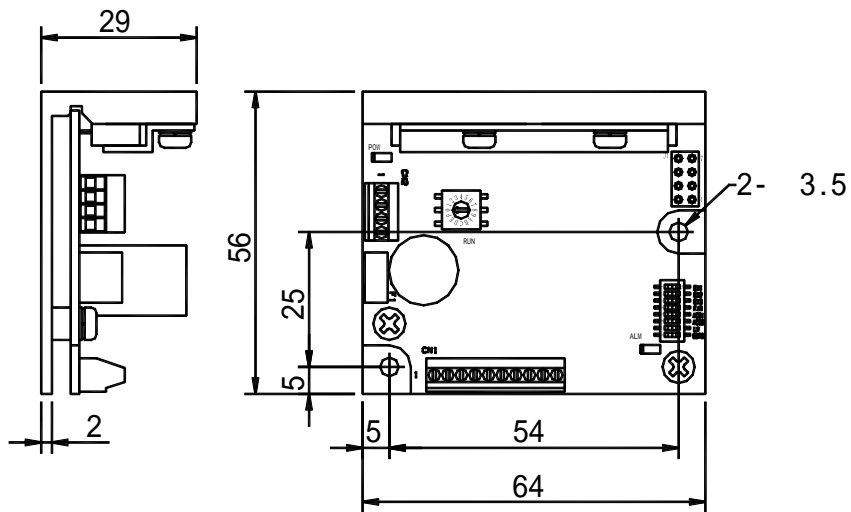

10. SAFETY STANDARD

SAFETY STANDARD

10.1	UL Standard	10-2
10.2	CE Marking	10-2
	10.2.1 Low Voltage Directive	10-2
	10.2.2 EMC Directive	10-2
10.3	Installation Procedure	10-3
10.4	Recommended EMC Measure Parts and Installation Procedure ..	10-4
	10.4.1 Power Cable Wirings	10-4
	10.4.2 Wirings between Driver and Controller	10-4
	10.4.3 Motor Power Cable Wirings	10-4

10. SAFETY STANDARD

10.1 UL Standard

The “BS1D200 ” complies with the UL (Underwriters Laboratories Inc.) standards.

Standard	File Number
UL Standard	E179775
UL Standard for Canada	

10.2 CE Marking

The conformity tests of Low Voltage Directive and EMC Directive are performed for BS1D200 as EC directives at the third party of qualified institutions. And CE marking self declaration has been executed.

10.2.1 Low Voltage Directive

Make sure to use the Driver under the installation environment of the following category and pollution level.

Over Voltage Category	Pollution Level	Standard
	2	EN 61010 - 1

10.2.2 EMC Directive

The conformity tests of EMC Standard compliance were performed for BS1D200 under the installation environment in figure 10 –1 and 10-2. However, since EMC changes depending upon user’s control board construction incorporated with the Driver and Stepping Motor, layout with the other electric devices or wirings, the conformity tests under the user’s installation environmental conditions can not be performed. Therefore, the final conformity tests of EMC compliance as entire machine and system should be performed by users.

Classification	Test	Standard
Emission	Terminal interference voltage	EN 55011 - A
	Electromagnetic radiation interference	EN 55011 - A
Immunity	Electrostatics immunity	EN - 61000 - 4 - 2
	Radiation field immunity	EN - 61000 - 4 - 3
	Electric fast transient burst immunity	EN - 61000 - 4 - 4
	Conductivity immunity	EN - 61000 - 4 - 6

10. SAFETY STANDARD

10.3 Installation Procedure

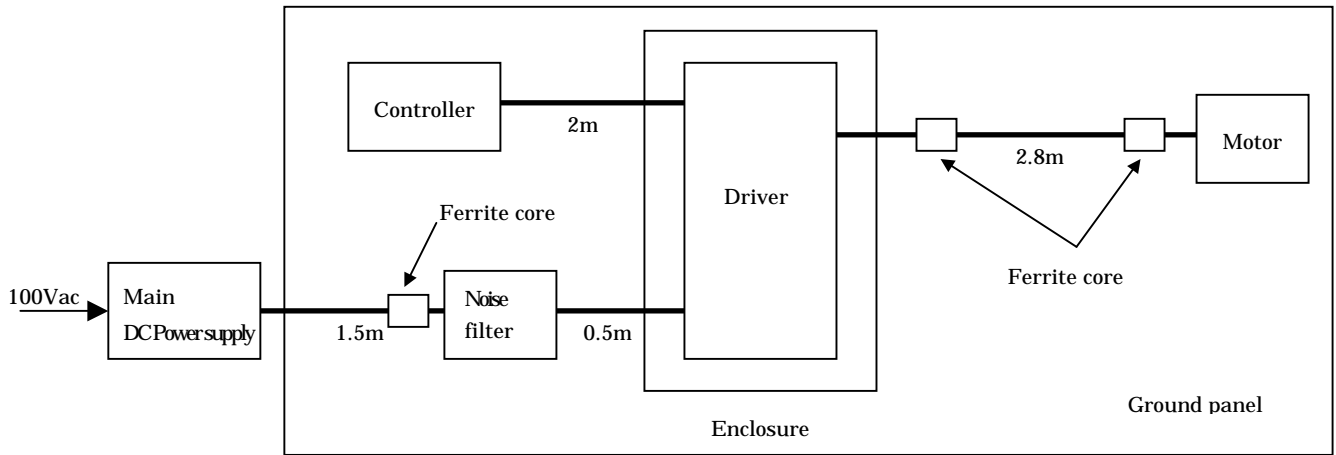

Fig.10-1 Installation Procedure for EMC test(Photo coupler type)

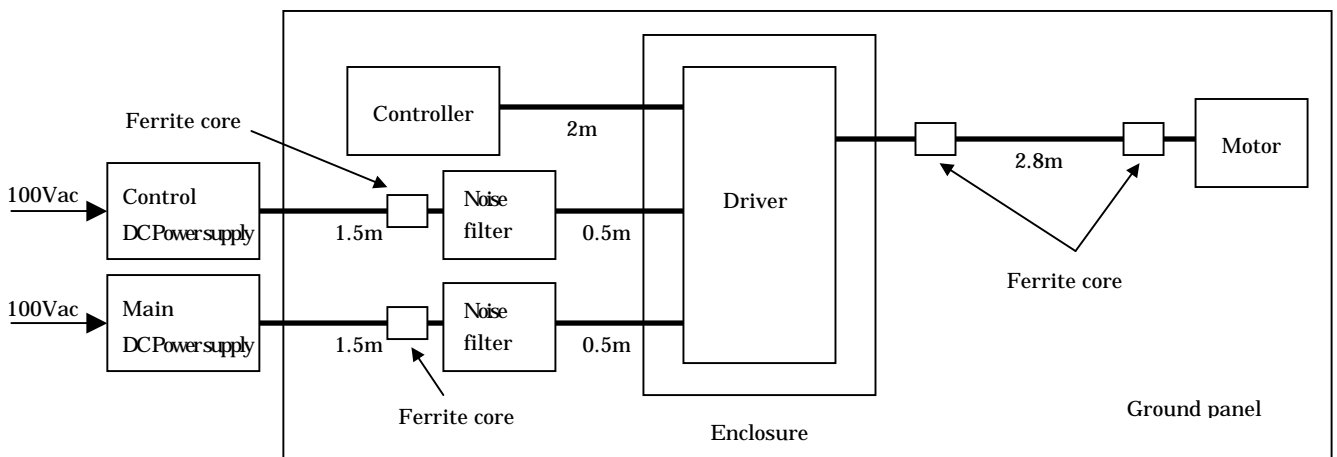

Fig.10-2 Installation Procedure for EMC test(C-MOS type)



Use the power supply so as not to be influenced by burst noise or surge noise.

10. SAFETY STANDARD

10.4 Recommended EMC Measure Parts and Installation Procedure

10.4.1 Power Cable Wirings

Note 1) Noise filter

Model	Specifications	Maker
SNA-06-223-T	Rated voltage: 50VDC Rated current: 6A	COSEL CO., LTD.

- * Make sure to earth the frame of noise filter.
- * The wiring for the primary and secondary sides of the noise filter should be away as possible.
- * The wiring from noise filter to Driver should be short as possible.
- * Wire the Driver to the secondary side of the noise filter.
- * The power cable should be shorter than 2m.

10.4.2 Wirings between Driver and Controller

- * The cable should be shorter than 2m.(Photo coupler type)
- * The cable should be shorter than 1m.(C-MOS type)

10.4.3 Motor Power Cable Wirings

Note 2) Hinged-clamp core

Model	Maker
E04ST402715D	SEIWA ELECTRIC MFG.CO., LTD.

- * Use shielded cable for wiring and make sure to earth the shielding sheath.
- * The cable should be shorter than 3m.
- * Install cores around the cable exit of the Stepping Motor and near the Driver connector.
- * Wind the Motor power line 3 turn around the Hinged-clamp core.



Failure to observe any of the cautions indicated on the right-hand side may cause a light to medium-degree injury or property damage. It may even lead to a serious disaster. Be sure to observe all of the cautions.

- Do not use any of these products for medical or other



CAUTION

equipment that may affect human lives.

- Do not use any of these products for equipment that may have a serious impact on society or the public.
- Do not use any of these products in a vehicle, ship, or other environment exposed to vibration.
- Do not remodel or machine any of these products.
- Before using any of these products, be sure to read its operation manual.

* If you have any questions or inquiries regarding the above, contact our Sales Department.

Home page <http://www.sanyodenki.co.jp>

SANYO DENKI CO.,LTD.

1-15-1, Kita-otsuka
Toshima-ku Tokyo 170-8451, JAPAN
Phone: +81 3 3917 5151
Fax: +81 3 3917 4521

AMERICA,INC

468 Amapola Avenue
Torrance, California 90501 U.S.A
Phone: (310) 783-5400 ~ 1
Fax: +81 3 3917 4521

SANYO DENKI EUROPE SA.

BP. 50286 95958 Roissy Charles-De-Gaulle
Cedex France
Phone: +33 1 48 63 26 61
Fax: +33 1 48 63 24 16

SANYO DENKI SANYO
SANYO DENKI