

DCジャック 2.1mm 基板取付け用 金属タイプ

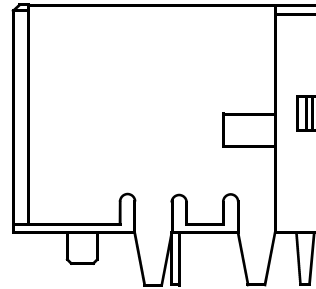

回路

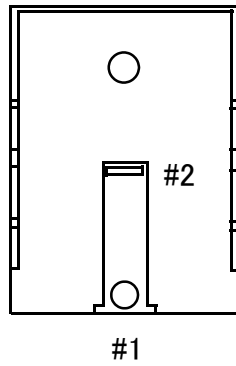
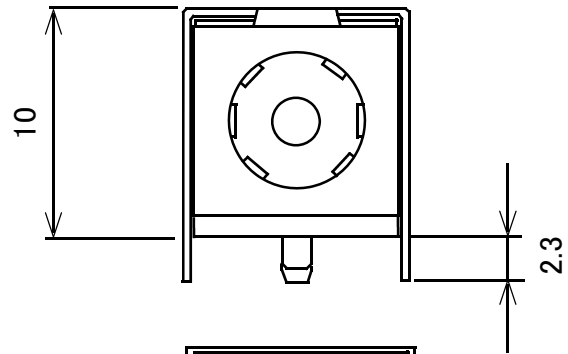
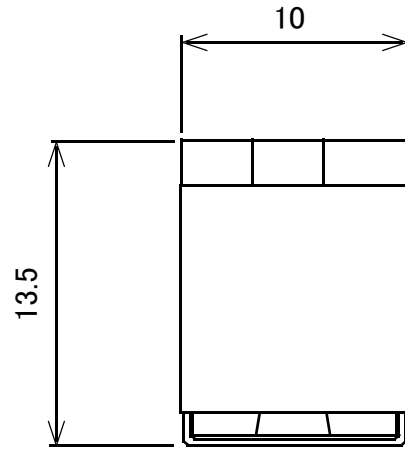
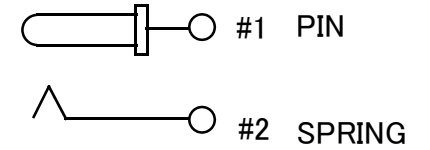

単位: mm

概略の実測値です。

詳細については現物での確認をお願いします。

MODEL No.	GB-DCJ-2125F-BM
DATE	2018,8,10