

## CTF SERIES PLASTIC D SUBMINIATURE SHELL (ACCESSORIES)

### General

HIROSE CTF series plastic D subminiature shells offer the highest quality of mechanical design and appearance. Available to fit 9, 15, 25, and 37 position connectors and

most competitors products. LN mounts allow for design flexibility.

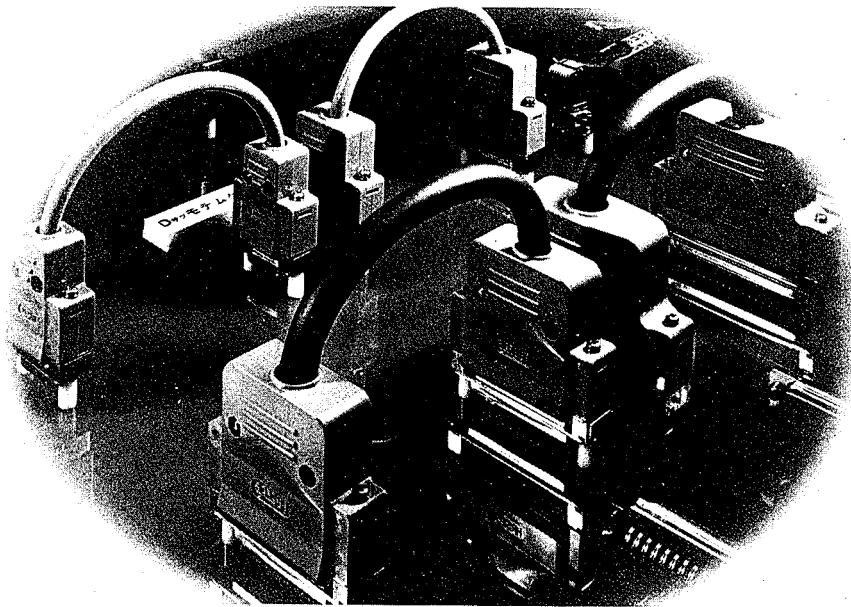

### Features

- (1) Standard screw type locking mechanism provides a strong and secure lock.
- (2) ABS resin molding material offers light weight, sturdy construction.
- (3) Easy to assemble and service because the case is split at the center of the cable inlet and few screws are used.
- (4) Two types of locking devices are available, rectangular and hexagonal, to meet different panel mounting complies.
- (5) The 25-contact model complies with the the modern plug case specified in JIS-C-6361.
- (6) Can easily incorporate solderling (HD) and crimping.

### Applications

Modems in communications equipment such as computers, peripherals and terminal equipment, control

equipment, measuring instruments, and export equipment.

## Materials

Part	Material	Finish
Plug case	ABS resin	2.5PB 6/2(color)
Locking device	Steel or zinc alloy die casting	Treatment with dichromate over zinc plating

## Ordering Information

### Plug case

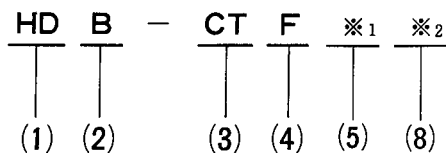

### Locking device

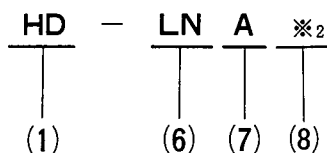

- (1) Connector series
- (2) Connector size: E (9 contacts), A (15 contacts), B (25 contacts), C (37 contacts)  
 Note: Not available for 50pos. cover.
- (3) Type of plug case  
 CT: Plug case with a vertical cable inlet opening
- (4) Serial sign for series  
 F: Plug case made of plastic
- (5) Locking screws  
 No sign: To be locked with a screwdriver  
 1: To be locked by hand
- (6) Locking device  
 LN: screw type locking device
- (7) Type of locking device  
 Provided with a sequence of upper-case alphabetic characters.  
 No sign: Rectangular  
 A: Hexagonal
- (8) Type of screw  
 Provided with a sequence of Arabic numerals.  
 No sign: M2.6  
 (4-40): inch

### Dataphone shell (To be locked with a screwdriver)

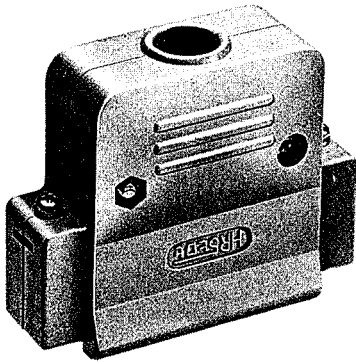

CL211-0139-0  
HDB-CTF

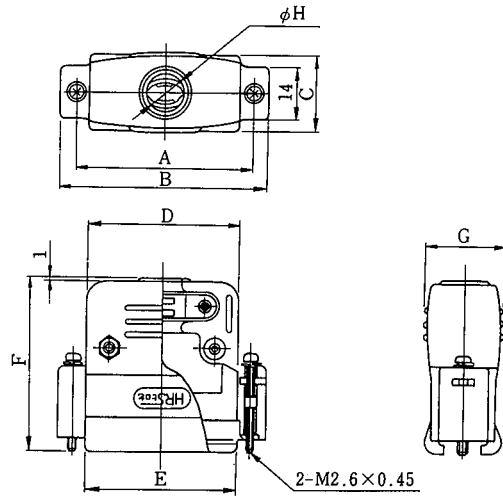

Note: Inch screw (4-40UNC) is also available.

Unit:mm

HRS No.	No. of Pin	Part No.	A	B	C	D	E	F	G	φ H
CL211-0159-8	9	HDE-CTF	24.99	33.2	18	19.3	19.2	40.2	19.6	7
CL211-0160-7	15	HDA-CTF	33.32	41.2	18	27.2	27.2	43.2	19.6	9
CL211-0139-0	25	HDB-CTF	47.04	55	20	40	40	46	20.8	10
CL211-0161-0	37	HDC-CTF	63.5	72.2	20	50.2	57	51.2	24	12

### Dataphone Shell (To be locked by hand)

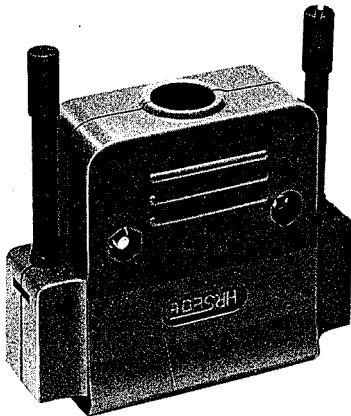

CL211-0166-3  
HDB-CTF1

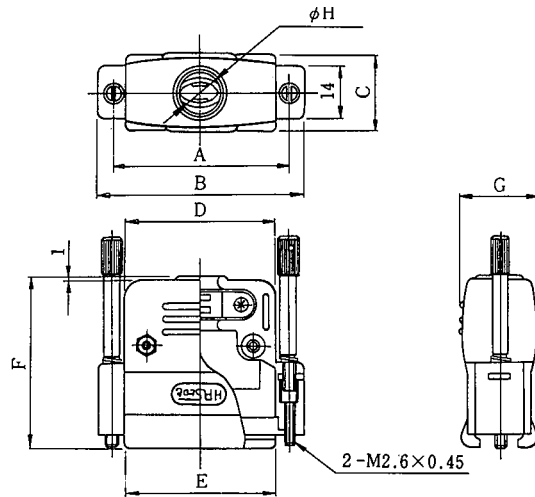

Unit:mm

HRS No.	No. of Pin	Part No.	A	B	C	D	E	F	G	φ H
* CL211-0168-9	9	HDE-CTF1	24.99	33.2	18	19.2	19.2	40.2	19.6	7
* CL211-0350-2	15	HDA-CTF1	33.32	41.2	18	27.2	27.2	43.2	19.6	9
* CL211-0166-3	25	HDB-CTF1	47.04	55	20	40	40	46	20.8	10
* CL211-0328-3	37	HDC-CTF1	63.5	72.2	20	50.2	57	51.2	24	12

\*: Standard

## SM Series (D SUB) Accessory

### Spring lock

Material

Body: Stainless steel

Screws: Steel

Finish

Screws: Treated with dichromate over zinc plating

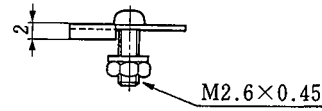
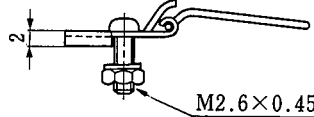
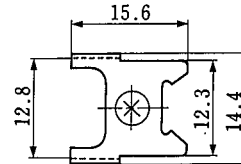
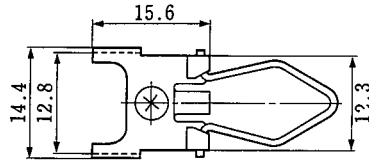
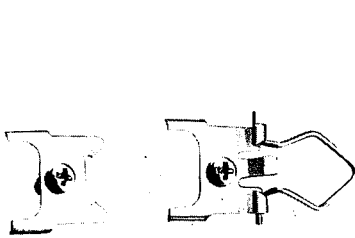

CL211-0122-8  
DA-L

CL211-0123-0  
DA-LP

### Sliding lock

D※-PLA  
(1)

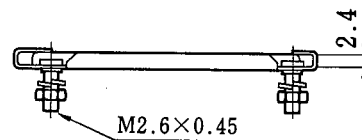
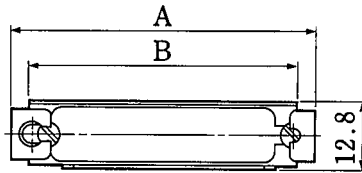
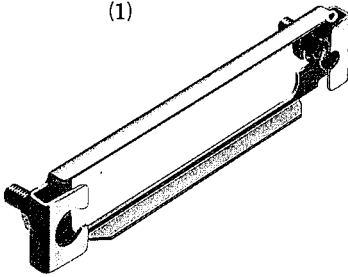

Material

Body: Stainless steel

Screws: Steel

Finish

Screws: Treated with dichromate over zinc plating

- (1) Connector size: E (9 contacts)  
 A (15 contacts)  
 B (25 contacts)  
 C (37 contacts)

HGS.No.	Part No.	A	B	No. of pin
CL211-0679-8	DE-PLA	35.37	28.51	9
CL211-0680-7	DA-PLA	43.7	36.84	15
CL211-0681-0	DB-PLA	57.42	50.56	25
CL211-0682-2	DC-PLA	73.88	67.02	37

D-PLB

CL211-0732-9

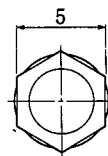
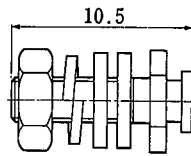

Material

Body: Steel

Finish

Screws: Treated with dichromate over zinc plating

Setup View

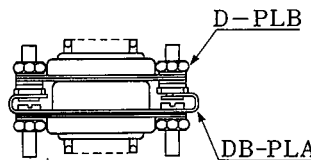

Notes (1) Minimum ordering quantity is one package, which contains two units.

(2) Applicable for any size of our connectors.

## SM Series (D SUB) Accessory

### Screw lock (for HD-LNA)

Note: Minimum ordering quantity is one package, which contains two units.

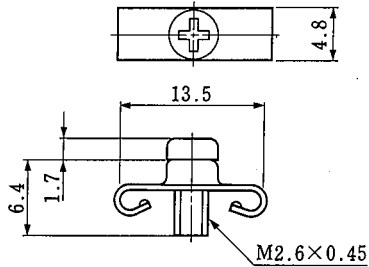
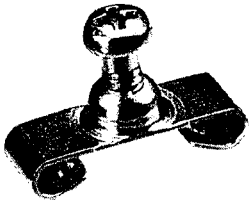

CL211-0307-3  
D-SLA

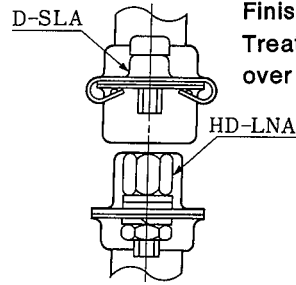

Setup View

**Material**  
 Body: Steel  
**Finish**  
 Treated with dichromate  
 over zinc plating

Before mounting the D-SLA, loosen the screw slightly

Note (1) Applicable for 9 to 37 contacts.

(2) Minimum ordering quantity is one package which contains two units.

### Locking device

Note: Minimum ordering quantity is one package, which contains two units.

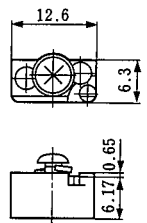
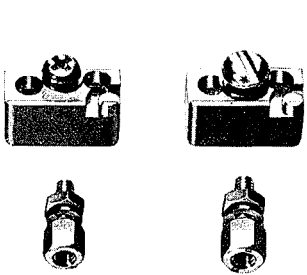

CL211-0140-0-02  
HD-LN(02)

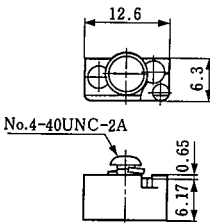

CL211-0171-3-02  
HD-LN(4-40) (02)



CL211-0172-6  
HD-LNA



CL211-0196-4  
HD-LNA(4-40)

	Applicable panel thickness	Finish
HD-LN	1.2mm or less	Treated with dichromate over zinc plating
HD-LN(4-40)		Treated with dichromate over zinc plating
HD-LN(02)	1.2-1.6mm	Treated with dichromate over zinc plating
HD-LN(4-40) (02)		Treated with dichromate over zinc plating

**Material**  
 Steel or zinc alloy  
**Finish**  
 Treated with dichromate over zinc plating

## SM Series (D SUB) Accessory

### Clamp

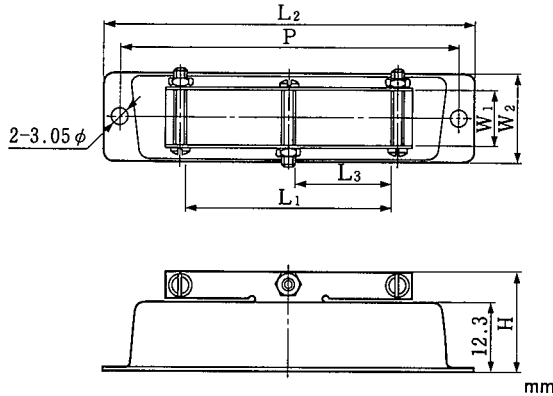
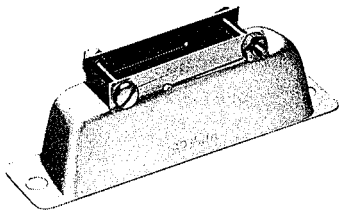

**Material**  
Steel  
**Finish**  
Treated with dichromate  
over zinc plating

HRS No.	Part No.	L <sub>1</sub>	L <sub>2</sub>	L <sub>3</sub>	P	W <sub>1</sub>	W <sub>2</sub>	H (reference)
* CL211-0018-6	HDE-C	7.3	30.6	—	24.99	7.5	12.7	16.3
* CL211-0005-4	HDA-C	8.0	38.9	—	33.32	7.5	12.7	16.3
* CL211-0011-7	HDB-C	20.2	52.8	—	47.04	7.5	12.7	16.3
* CL211-0059-3	HDC-C	37.0	69.1	17.5	63.5	7.5	12.7	16.3
* CL211-0006-7	HDD-C	37.0	66.7	17.5	61.11	9.9	15.5	17.6

\* standard

### Dust cap

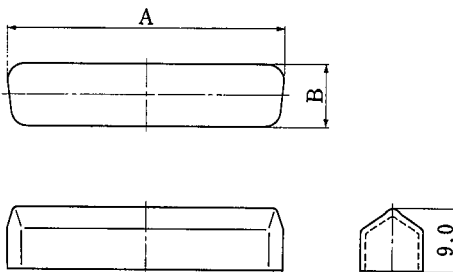
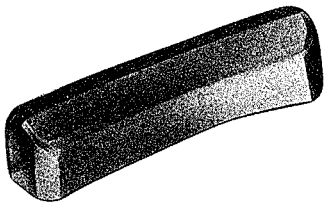

**Material**  
Vinyl chloride (UL94V-2)  
**Finish**  
Color: Light blue

	HRS No.	No. of pin	Part No.	A	B		HRS No.	No. of pin	Part No.	A	B
	For male connector	CL211-0777-7	9	DE-9P-DC1	18.7		10.2	For female connector	CL211-0782-7	9	DE-9S-DC1
CL211-0778-0		15	DA-15P-DC1	27.0	10.2	CL211-0783-0	15		DA-15S-DC1	25.6	8.8
CL211-0779-2		25	DB-25P-DC1	41.0	10.4	CL211-0784-2	25		DB-25S-DC1	39.3	8.8
CL211-0780-1		37	DC-37P-DC1	57.7	10.6	CL211-0785-5	37		DC-37S-DC1	55.8	8.8
CL211-0781-4		50	DD-50P-DC1	55.0	13.3	CL211-0786-8	50		DD-50S-DC1	53.4	11.6

Note: Dust cap for male connector cannot be used for the connector with locking device (LN)

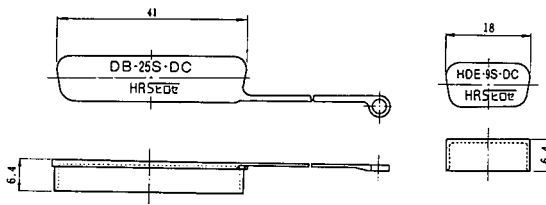
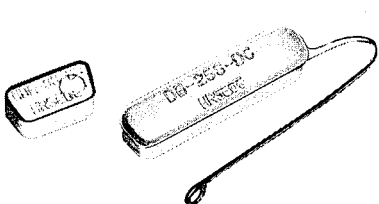

**Material**  
Polyethylene resin  
**Finish**  
Color: Natural

CL211-0162-2  
DB-25S-DC

CL211-0130-6  
HDE-9S-DC