

Model No.

JL-0622C

SPECIFICATION
of **Electret Condenser Microphone**
(RoHS Compliance)

Model No.: JL-0622C

:

ISSUED BY	J.C	03-24-2003
CHECKED BY		
APPROVED BY		

Scope: The specification describes the requirements of an omni-directional condenser Microphone.

1、Electrical requirements: $V_{cc}=2.0V$, $R_L=2.2K\Omega$

Items	Description	Min	TYP	Max	Unit
Sensitivity	$f=1KHz$, $P_{in}=1Pa$	-43	-40	-37	dB
Output impedance	$f=1KHz$, $P_{in}=1Pa$			2.2K	Ω
Directivity	Omni-directional				
Power consumption				500	μA
S/N ratio	A-weight, at 1Pa	60			dB
Max. input SPL	THD<1%		120		dB
Sensitivity reduction	V_{cc} from 2.0V to 1.0V			-3	dB
Operating voltage range		1.0		10	V

2、Frequency response

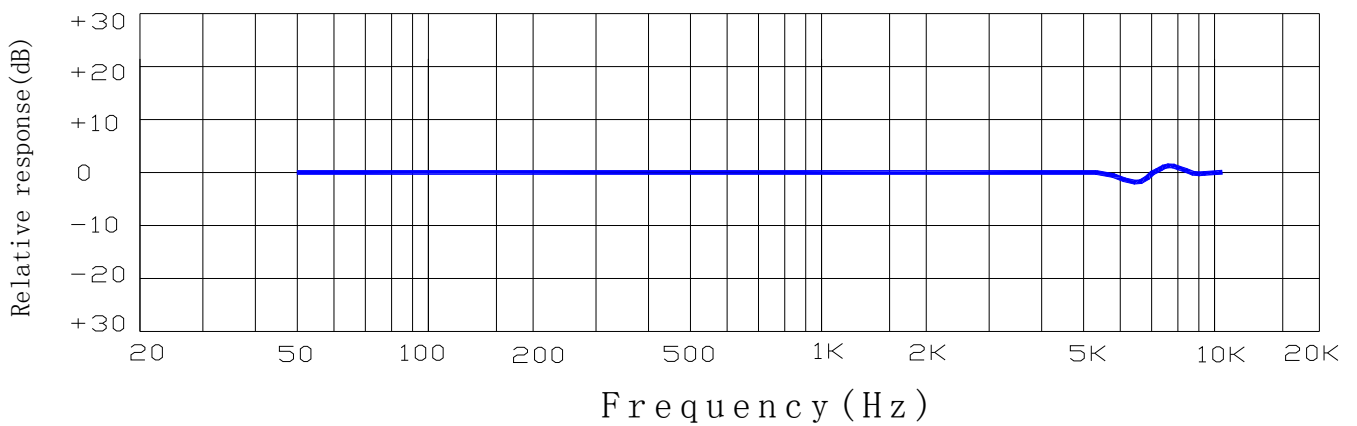

3、Measurement schematic :

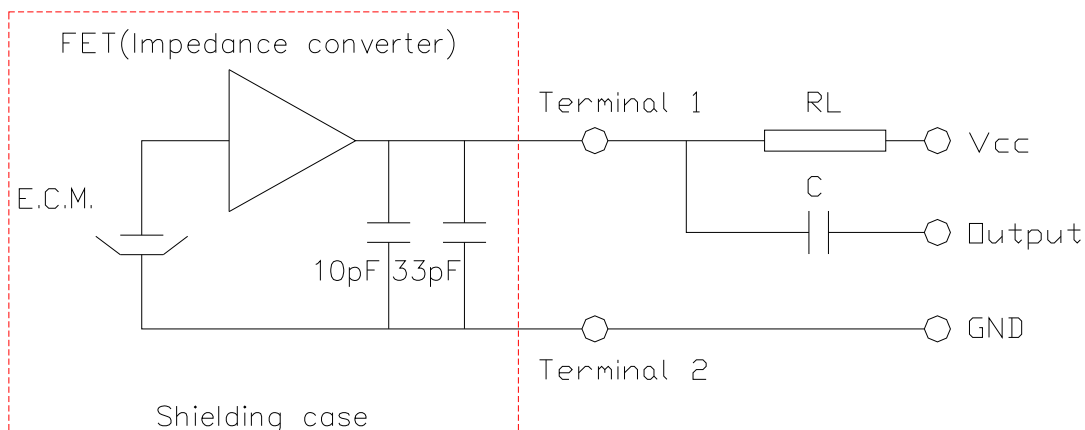

4 · Mechanical requirements :

3-1 · Dimension : $\varnothing 6.0 \times 2.2$ mm3-3 · Soldering heat shock : After soldering heat shock at $310 \pm 5^\circ\text{C}$ for 2 ± 1 seconds.
The microphone should be without damage.3-4 · Terminal strength : After applied a 1 Kg force on terminal for 1 minute.
The microphone should be without damage.3-5 · Operating temperature range : $-20^\circ\text{C} \sim 70^\circ\text{C}$ 3-6 · Storage temperature range : $-30^\circ\text{C} \sim 85^\circ\text{C}$

5 · Reliability test :

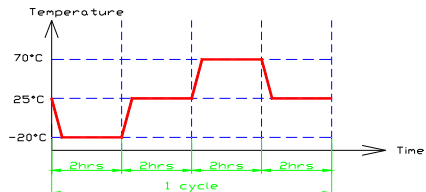
Vibration test	After vibrations with 10Hz~55Hz , full amplitude 2mm to each 3 per-pendicular directions for 30 minutes at three axes. The sensitivity should be within ± 3 dB form initial value.
Drop test	After drop from 1 meter height to concrete floor , each 5 face for 5 times with packing. The sensitivity should be with ± 3 dB from initial value.
Humidity test	After exposure at $40 \pm 2^\circ\text{C}$ and 90%~95% humidity for 48 hours. The sensitivity should be with ± 3 dB form initial value. (The measurement should be done after 3 hours at conditioning $25 \pm 2^\circ\text{C}$.)
High temperature test	After exposure at $85 \pm 2^\circ\text{C}$ for 72 hours. The sensitivity should be with ± 3 dB from initial value. (The measurement should be done after 3 hours at conditioning $25 \pm 2^\circ\text{C}$.)
Low temperature test	After exposure at $-30 \pm 2^\circ\text{C}$ for 72 hours. The sensitivity should be with ± 3 dB from initial value. (The measurement should be done after 3 hours at conditioning $25 \pm 2^\circ\text{C}$.)
Temperature cycle test	After exposure at $-20 \pm 2^\circ\text{C}$ for 2 hours , at $25 \pm 2^\circ\text{C}$ for 2 hours , at $70 \pm 2^\circ\text{C}$ for 2 hours , 5 cycles. The sensitivity should be with ± 3 dB from initial value. (The measurement should be done after 3 hours at conditioning $25 \pm 2^\circ\text{C}$.) 

6 · Microphone dimension :

Unit : mm

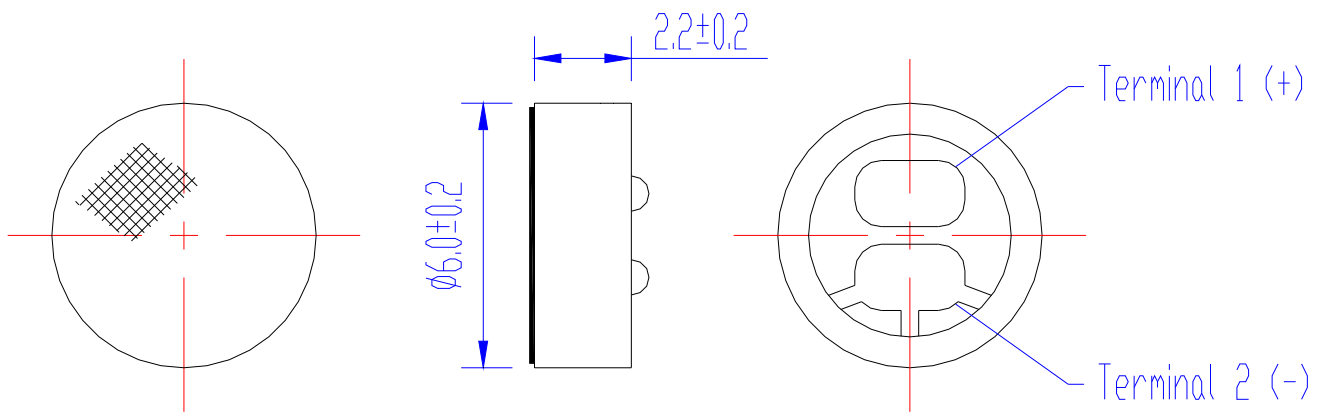

7 · Packing

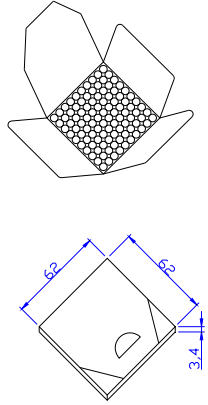
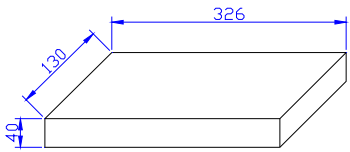
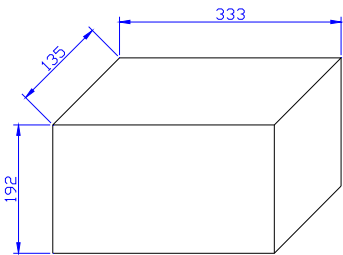
	Drawing	Quantity	Material	Re-mark
Inner packing		100 pcs / box	Box White paper 62x62x3.4mm	Label: Model No. Q'ty: QC mark RoHS mark
Middle box		100x7x10 =7,000pcs	White paper 326x130x40mm	Label: Model No.: Q'ty: RoHS mark
Outer carton		7,000x4 =28,000 pcs	Paper 333x135x192mm	Label Model No.: Q'ty: RoHS mark