

# KW1-521CBB

## DATA SHEET

QC:

ENG:

Prepared By:

Part No.	KW1-521CBB	Spec No.	S/N-050127003D	Page	1 of 4
----------	------------	----------	----------------	------	--------

## Package Dimension:

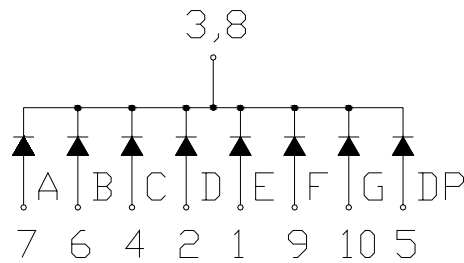
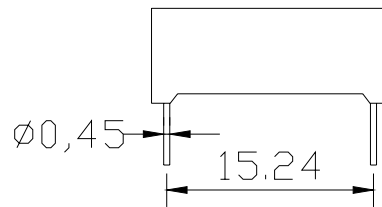
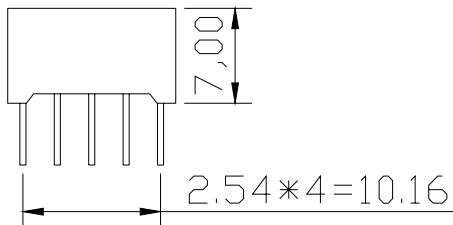
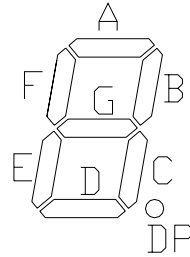
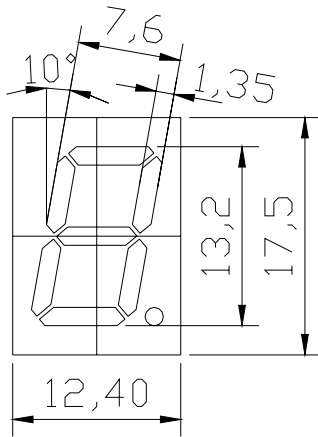

Part NO.	Chip Material	Source Color
KW1-521CBB	GaInN	Blue

### Notes:

1. All dimensions are in millimeters (inches).
2. Tolerance is  $\pm 0.25(.010)$  mm unless otherwise noted.
3. Specifications are subject to change without notice.

## Absolute Maximum Ratings at Ta=25

Parameter	MAX.	Unit
Power Dissipation	100	mW
Peak Forward Current (1/10 Duty Cycle, 0.1ms Pulse Width)	100	mA
Continuous Forward Current	35	mA
Derating Linear From 50	0.4	mA/
Reverse Voltage	5	V
Operating Temperature Range	-40 to +80	
Storage Temperature Range	-40 to +80	
Lead Soldering Temperature [1.6mm(.063") From Body]	260 for 5 Seconds	

## Electrical Optical Characteristics at Ta=25

Parameter	Symbol	Min.	Typ.	Max.	Unit	Test Condition
Luminous Intensity	I <sub>v</sub>	15	30	45	mcd	I <sub>F</sub> =20mA (Note 1)
Peak Emission Wavelength	λ <sub>p</sub>	460	468	472	nm	I <sub>F</sub> =20mA
Spectral Line Half-Width		35	40	45	nm	I <sub>F</sub> =20mA
Forward Voltage	V <sub>F</sub>	3.0	3.5	4.0	V	I <sub>F</sub> =20mA
Reverse Current	I <sub>R</sub>	---	---	100	μA	V <sub>R</sub> =5V

### Note:

1. Luminous intensity is measured with a light sensor and filter combination that approximates the CIE eye-response curve.

### Typical Electrical / Optical Characteristics Curves

Part No.	KW1-521CBB	Spec No.	S/N-050127003D	Page	3 of 4
----------	------------	----------	----------------	------	--------

(25 Ambient Temperature Unless Otherwise Noted)

**Spectral Radiance (Peak @ 468nm)**

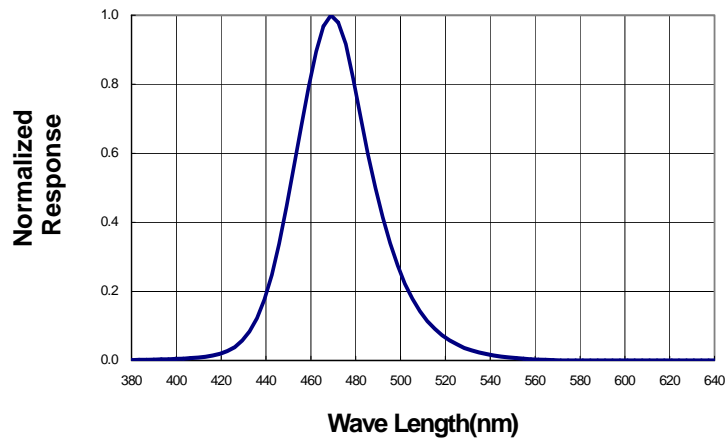

**Forward Current vs Forward Voltage**

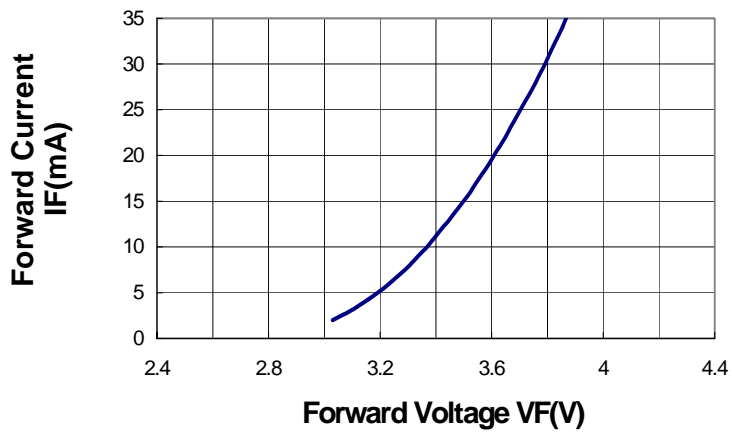

**Relative Luminous Intensity vs Forward Current**

