

LENNOO 聯宇電子股份有限公司

LENNOO ELECTRONICS CO., LTD.

新北市土城區永豐路 187 號

NO. 187, Yung Feng Road, Tucheng Dist.,

New Taipei City, Taiwan (R.O.C).

TEL:886-2-22619999 (REP.) FAX:886-2-22616699 (REP.)

APPROVAL SHEET

CUSTOMER: _____

CUSTOMER PART NO. _____

TYPE NO.: LIR053

PACKAGE SIZE: 5mm Round Type Infrared LED

DICE MATERIAL: GaAlAs / GaAs **PEAK WAVE LENGTH(nm)** 940

EMITTED COLOR: Invisible **VIEWING ANGLE (deg):** 16

LENS COLOR: Blue Transpaent

RADIANT INTENSITY(mW/sr): 14

**CUSTOMER
ENGINEERING DEPARTMENT**

**LENNOO ELECTRCNICS CO., LTD.
ENGINEERING DEPARTMENT**

(Authorized Signature)

APPROVED DATE _____

ISSUED DATE _____

LENOO ELECTRONICS CO., LTD.

INFRARED EMITTING DIODE

TYPE NO.:LIR053

GENERAL DESCRIPTION

THE LIR034, LIR034C AND LIR053, LIR053C ARE HIGH INTENSITY GALLIUM ARSENIDE INFRARED EMITTING DIODES ENCAPSULATED IN BLUE TRANSPARENT OR WATER CLEAR PLASTIC PACKAGE IN T-1 OR T-13/4 DIVIDUALLY

APPLICATION

- 1 REMOTE CONTROL
- 2 SMOKE DETECTOR
- 3 PHOTO DETECTOR
- 4 BURGLAR ALARM
- 5 COMPUTER I/O PERIPHERAL
- 6 AUTOMATIC CONTROL SYSTEM
- 7 INDUSTRIAL USE

FEATURES

- 1 HI-RADIANT INTENSITY
- 2 LOW-AVERAGE DEGRADATION
- 3 MECHANICALLY AND SPECTRALLY MATCHED TO THE LPT051 , LPT032 SERIES OF PHOTOTRANSISTOR AND THE LPD923K,LPD913K SERIES OF PHOTO DIODES.

ELECTRICAL CHARACTERISTICS

| Parameter | Symbol | Min | Typ | Max | Unit | Test |
|----------------------------|-----------------|-----|------|-----|--------------------|---------|
| Aperture Radiant incidence | Ee | 0.2 | 0.35 | — | mW/cm ² | If=20mA |
| Radiant intensity | Ie | 10 | 14 | — | mW/sr | If=20mA |
| Peak Emission Wavelength | λ_p | — | 940 | — | nm | If=20mA |
| Forward Voltage | V _F | — | 1.2 | 1.4 | v | If=20mA |
| Spectral Line Half-Width | $\Delta\lambda$ | — | 50 | — | nm | If=20mA |
| Reverse Current | I _R | — | 0 | 100 | uA | VR=5V |
| Viewing Angle | 2 θ 1/2 | — | 16 | — | Degree | |
| Rise Time | T _R | — | — | 600 | nS | — |
| Fall Time | T _F | — | — | 600 | nS | — |

ABSOLUTE MAXIMUM RATING

| Parameter | Maximum Rating | Unit |
|---|-----------------|------|
| Power Dissipation | 100 | mW |
| Peak Forward Current(Pulse width = 10us 1% duty cycle) | 1 | A |
| Continuous Forward Current | 50 | mA |
| Reverse Voltage | 5 | V |
| Operating Temperature Range | -40°C to +85°C | |
| Storage Temperature Range | -40°C to +100°C | |
| Lead Soldering Temperature (1/16 inch from Body for 5sec) | 260°C | |

LENOO

INFRARED LED PACKAGE DIMENSIONS

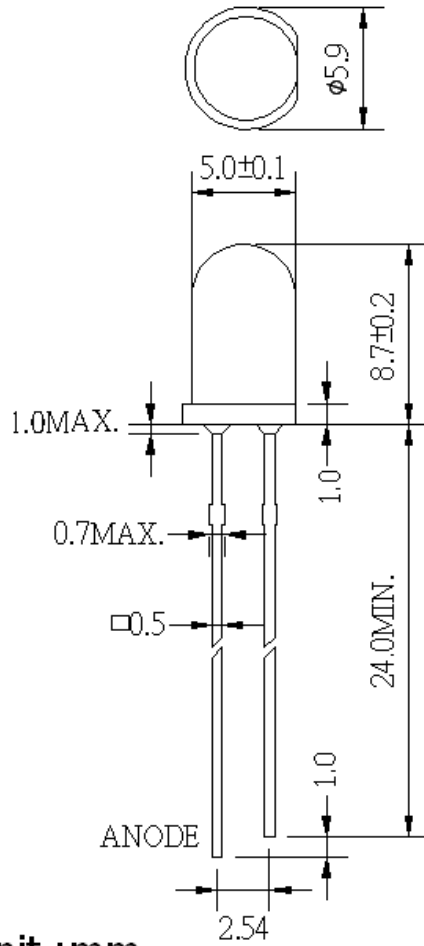

Unit : mm

| | | |
|--|---------------------|-----------------|
| DEVICE NO.:LIR053 | DRAWING NO. | ENGINEER |
| ALL TOLERANCE SHALL BE ± 0.01 inch/0.25mm UNLESS OTHERWISE NOTED | DRAWING DATE | APPROVER |

Typical Electro-Optical Characteristics Curves

Infrared (GaAs $\lambda_P=940\text{nm}$)

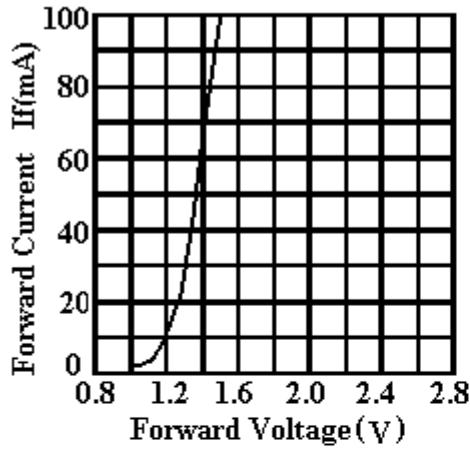

Forward current vs. Forward Voltage

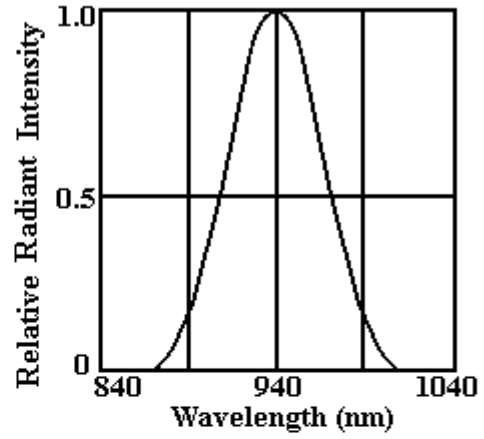

Spectral Distribution

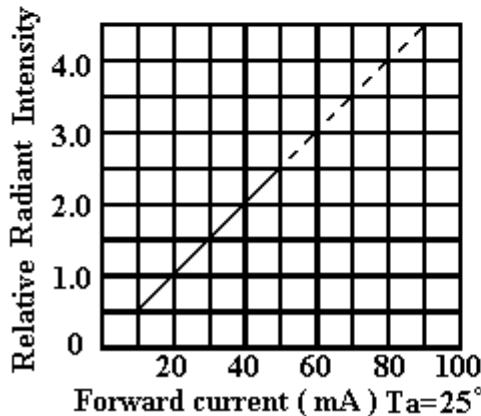

Radiant Intensity vs. Forward current

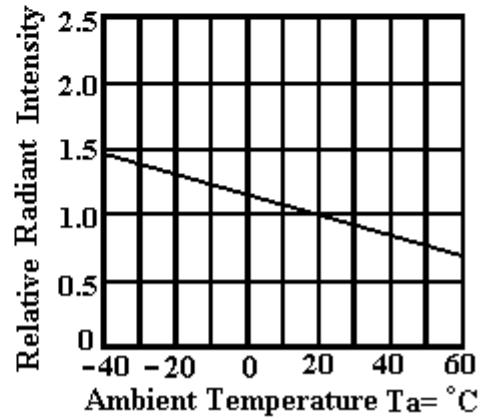

Radiant Intensity vs. Ambient Temperature

LED Infrared (None-Visible)

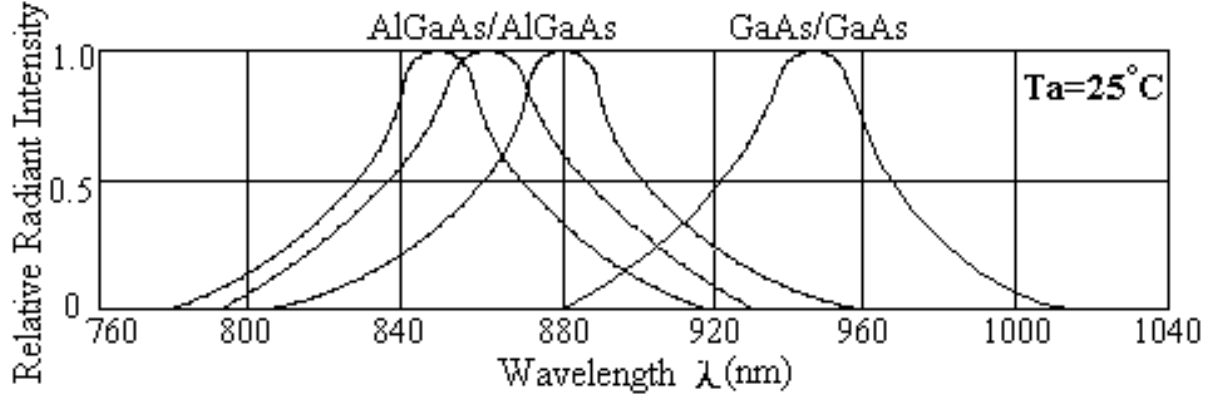

Relative Intensity Vs. Wavelength

Reliability test For LED Lamps

Type No. :LIR053

| NO. | Item | Test Conditions | Test Time/ Cycle | Sample Size | Ac/Re |
|------------|-----------------------------------|--|-----------------------------|--------------------|--------------|
| 1 | DC Operating Life | Temperature:25°C IF:20mA | 1000HRS | 20PCS | 0/1 |
| 2 | High Temperature High Humidity | Temperature:85°C 85%RH | 1000HRS | 20PCS | 0/1 |
| 3 | High Temperature Storage | Temperature:100°C | 1000HRS | 20PCS | 0/1 |
| 4 | Low Temperature Storage | Temperature: - 40°C | 1000HRS | 20PCS | 0/1 |
| 5 | Temperature Cycling | 85°C ~ 25°C ~ - 35°C 15min ~ 5min ~ 15min | 15Cycles | 20PCS | 0/1 |
| 6 | Thermal Shock | 85°C ~ 25°C ~ - 10°C 5min ~ 10sec ~ 5min | 15Cycles | 20PCS | 0/1 |
| 7 | Solder Heat | Temperature:260°C±5°C | 10SEC. | 20PCS | 0/1 |

Precautions For Use LED**1. Drive Method**

LED is current-operated device. In order to ensure intensity uniformity on multiple LEDs connected in parallel in a application, it is recommended that a current limiting resistor be incorporated in the drive circuit.

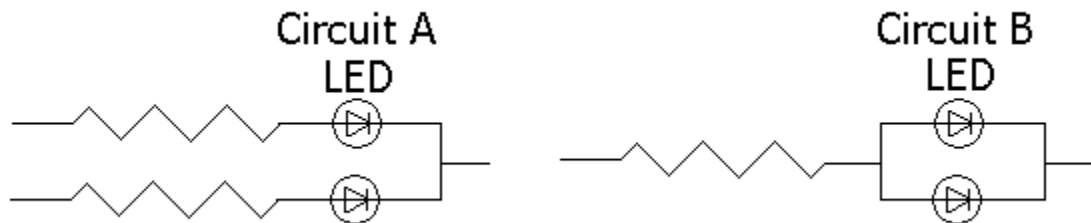

(a) Circuit A it is recommended circuit.

(b) Circuit B the brightness of each LED might appear different due to the differences in the I-V characteristics of those LEDs.

2. Over-current-proof

Customer must apply resistors for protection , otherwise slight voltage shift will cause big current change(Burn out will happen).

3. Storage

The Storage Temperature and RH are: $5^{\circ}\text{C} \sim 30^{\circ}\text{C}$, RH 60% or less.

Once the package is opened, the products should be used with in a week. Otherwise, they should be kept in moisture proof package with moisture absorbent material (silica gel). we suggest our customers to use our products within a year.

If the moisture absorbent material (silica gel) has faded away or the LEDs exceeded the storage time , baking treatment should be performed using the following conditions.

Baking treatment: more than 24 hours at $60^{\circ}\text{C} \pm 5^{\circ}\text{C}$.

4. Electrostatic Discharge (ESD)

Static electricity or surge voltage will damage the LEDs

Suggestions to prevent ESD damage:

Use of a conductive wrist band or ante-electrostatic glove when handing these LEDs

All devices, equipment, and machinery must be properly grounded.

Work tables storage racks, etc. should be properly grounded

In the events of manual working in process, make sure the devices are well protected from ESD at any time.

5. Others

- (a) If want to have the uniform luminance and color, please use the same binning number, and avoid using intermix to cause the differences of luminance and color.
- (b) The appearance and specifications of the product may be modified for improvement without prior notice.

6. Soldering

Recommended soldering condition as shown below:

Soldering heat (DIP)

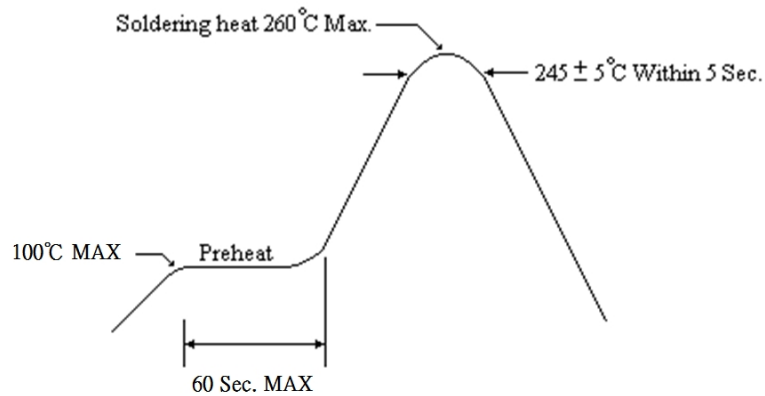

Soldering Iron

Temperature at tip of iron : 350°C Max.

Soldering Time: 3 sec. ± 1 sec. (one time only)

If temperature is higher, time should be shorter

Reflow Temp./Time(SMD)

