

LENOO 聯宇電子股份有限公司

LENOO ELECTRONICS CO., LTD.

新北市土城區永豐路 187 號

NO. 187, Yung Feng Road, Tucheng Dist.,

New Taipei City, Taiwan (R.O.C.)

TEL:886-2-22619999 (REP.) FAX:886-2-22616699 (REP.)

APPROVAL SHEET

CUSTOMER: _____

CUSTOMER PART NO. _____

TYPE NO.: LSIR034

PACKAGE SIZE: 3mm Round Type Super Infrared LED

DICE MATERIAL: GaAlAs / GaAlAs PEAK WAVE LENGTH(nm) 880

EMITTED COLOR: Invisible VIEWING ANGLE (deg): 30

LENS COLOR: Blue Transparent

RADIANT INTENSITY (mW/sr): 14

CUSTOMER
ENGINEERING DEPARTMENT

LENOO ELECTRONICS CO., LTD.
ENGINEERING DEPARTMENT

(Authorized Signature)

APPROVED DATE _____

ISSUED DATE _____

LENOO ELECTRONICS CO., LTD.

SUPER INFRARED EMITTING DIODE

TYPE NO.:LSIR034

GENERAL DESCRIPTION

THE LSIR034, LSIR034C AND LSIR053, LSIR053C ARE SUPER INTENSITY GALLIUM ALUMINUM ARSENIDE INFRARED EMITTING DIODES ENCAPSULATED IN BLUE TRANSPARENT OR WATER CLEAR PLASTIC PACKAGE IN T-1 OR T-13/4 DIVIDUALLY

APPLICATION

- 1 REMOTE CONTROL
- 2 SMOKE DETECTOR
- 3 PHOTO DETECTOR
- 4 BURGLAR ALARM
- 5 COMPUTER I/O PERIPHERAL
- 6 AUTOMATIC CONTROL SYSTEM
- 7 INDUSTRIAL USE

FEATURES

- 1 HI-RADIANT INTENSITY
- 2 LOW-AVERAGE DEGRADATION
- 3 MECHANICALLY AND SPECTRALLY MATCHED TO THE LPT051 , LPT032 SERIES OF PHOTOTRANSISTOR AND THE LPD923K,LPD913K SERIES OF PHOTO DIODES.

ELECTRICAL CHARACTERISTICS

Parameter	Symbol	Min	Typ	Max	Unit	Test
Aperture Radiant incidence	Ee	0.2	0.5	—	mW/cm ²	If=20mA
Radiant intensity	Ie	10	14	—	mW/sr	If=20mA
Peak Emission Wavelength	λ_p	—	880	—	nm	If=20mA
Forward Voltage	V _F	—	1.3	1.6	v	If=20mA
Spectral Line Half-Width	$\Delta\lambda$	—	70	—	nm	If=20mA
Reverse Current	I _R	—	0	100	uA	VR=5V
Viewing Angle	2 θ 1/2	—	30	—	Degree	
Rise Time	T _R	—	—	500	nS	—
Fall Time	T _F	—	—	500	nS	—

ABSOLUTE MAXIMUM RATING

Parameter	Maximum Rating	Unit
Power Dissipation	100	mW
Peak Forward Current(Pulse width = 10us 1% duty cycle)	1	A
Continuous Forward Current	60	mA
Reverse Voltage	5	V
Operating Temperature Range	-40°C to +85°C	
Storage Temperature Range	-40°C to +100°C	
Lead Soldering Temperature (1/16 inch from Body for 5sec)	260°C	

LENOO *SUPER INFRARED LED PACKAGE DIMENSIONS*

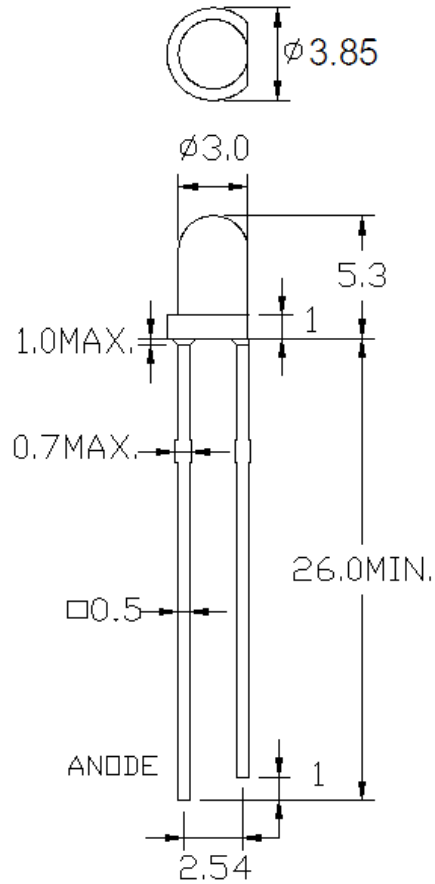

DEVICE NO.:LSIR034	DRAWING NO.	ENGINEER
ALL TOLERANCE SHALL BE $\pm 0.01 \text{ inch}/0.25 \text{ mm}$ UNLESS OTHERWISE NOTED	DRAWING DATE	APPROVER

LENOO ELECTRONICS CO., LTD.

Typical Electro-Optical Characteristics Curves

Infrared (GaAlAs $\lambda_P=880\text{nm}$)

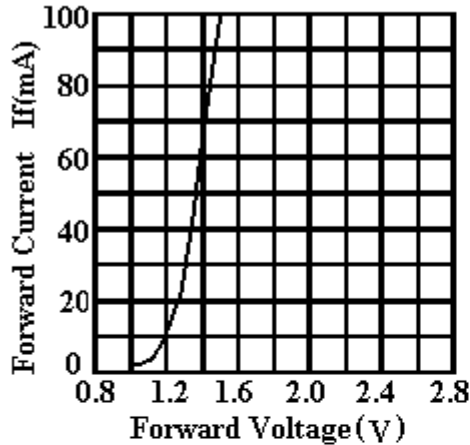

Forward current vs. Forward Voltage

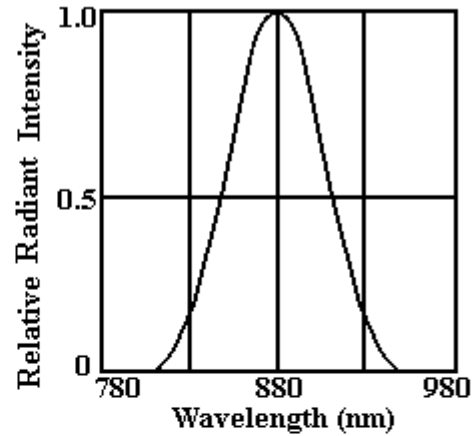

Spectral Distribution

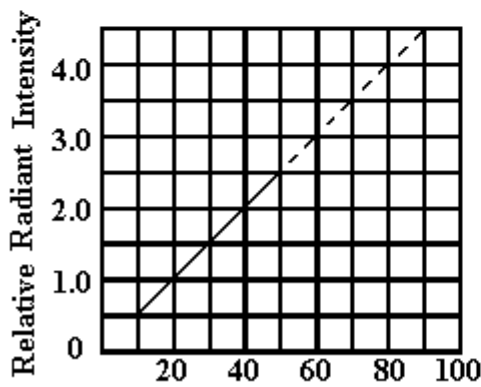

Radiant Intensity vs. Forward current

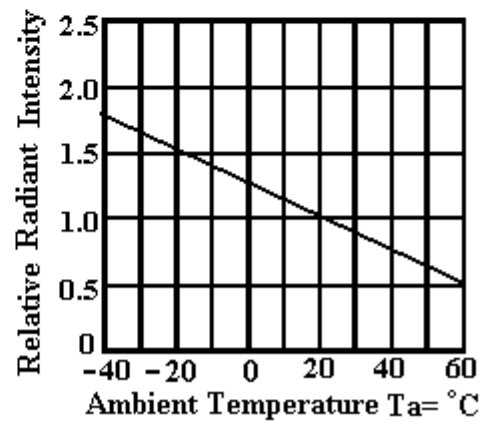

Radiant Intensity vs. Ambient Temperature

LED Infrared (None-Visible)

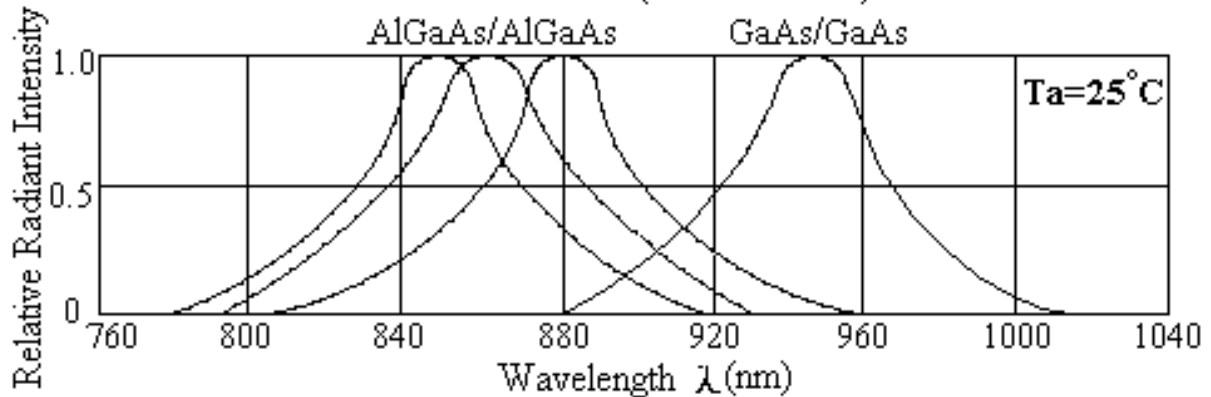

Relative Intensity Vs. Wavelength

Reliability test For LED Lamps

Type No. :LSIR034

NO.	Item	Test Conditions	Test Time/ Cycle	Sample Size	Ac/Re
1	DC Operating Life	Temperature:25°C IF:20mA	1000HRS	20PCS	0/1
2	High Temperature High Humidity	Temperature:85°C 85%RH	1000HRS	20PCS	0/1
3	High Temperature Storage	Temperature:100°C	1000HRS	20PCS	0/1
4	Low Temperature Storage	Temperature: - 40°C	1000HRS	20PCS	0/1
5	Temperature Cycling	85°C ~ 25°C ~ - 35°C 15min ~ 5min ~ 15min	15Cycles	20PCS	0/1
6	Thermal Shock	85°C ~ 25°C ~ - 10°C 5min ~ 10sec ~ 5min	15Cycles	20PCS	0/1
7	Solder Heat	Temperature:260°C±5°C	10SEC.	20PCS	0/1

Precautions For Use LED**1. Drive Method**

LED is current-operated device. In order to ensure intensity uniformity on multiple LEDs connected in parallel in a application, it is recommended that a current limiting resistor be incorporated in the drive circuit.

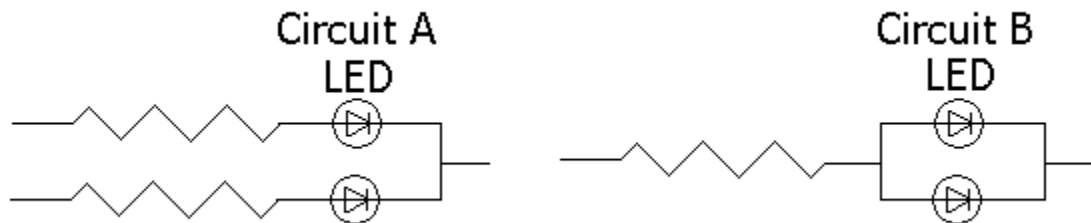

(a) Circuit A it is recommended circuit.

(b) Circuit B the brightness of each LED might appear different due to the differences in the I-V characteristics of those LEDs.

2. Over-current-proof

Customer must apply resistors for protection , otherwise slight voltage shift will cause big current change(Burn out will happen).

3. Storage

The Storage Temperature and RH are: $5^{\circ}\text{C} \sim 30^{\circ}\text{C}$, RH 60% or less.

Once the package is opened, the products should be used with in a week. Otherwise, they should be kept in moisture proof package with moisture absorbent material (silica gel). we suggest our customers to use our products within a year.

If the moisture absorbent material (silica gel) has faded away or the LEDs exceeded the storage time , baking treatment should be performed using the following conditions.

Baking treatment: more than 24 hours at $60^{\circ}\text{C} \pm 5^{\circ}\text{C}$.

4. Electrostatic Discharge (ESD)

Static electricity or surge voltage will damage the LEDs

Suggestions to prevent ESD damage:

Use of a conductive wrist band or ante-electrostatic glove when handing these LEDs

All devices, equipment, and machinery must be properly grounded.

Work tables storage racks, etc. should be properly grounded

In the events of manual working in process, make sure the devices are well protected from ESD at any time.

5. Others

- (a) If want to have the uniform luminance and color, please use the same binning number, and avoid using intermix to cause the differences of luminance and color.
- (b) The appearance and specifications of the product may be modified for improvement without prior notice.

6. Soldering

Recommended soldering condition as shown below:

Soldering heat (DIP)

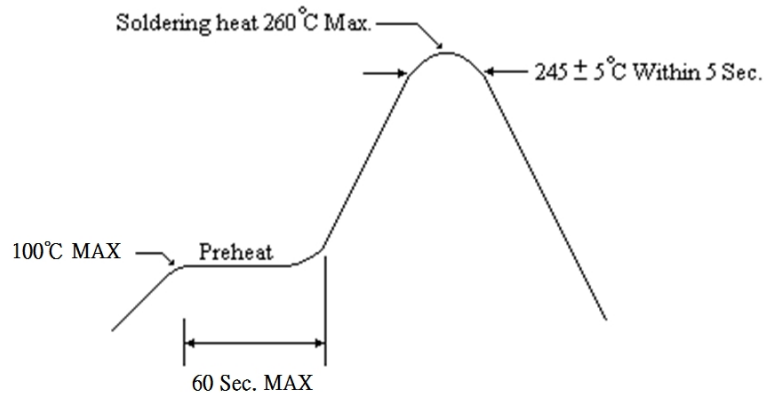

Soldering Iron

Temperature at tip of iron : 350°C Max.

Soldering Time: 3 sec. ± 1 sec. (one time only)

If temperature is higher, time should be shorter

Reflow Temp./Time(SMD)

