

# APPROVAL SHEET

**DESCRIPTION:** PUSH BUTTON SWITCH LED

**PART NO:** PS004-L22NPS2HKKUWXX

<b>CUSTOMER:</b> <u>Martsu</u>	<b>CUSTOMER'S PART NO:</b> _____
<b>CUSTOMER SIGNATURE</b>	<b>COMMENTS</b>

<b>APPROVAL</b>	<b>REVIEW</b>	<b>PREPARE</b>
<i>Kaven</i>	<i>Tereance</i>	<i>Gina</i>

DIMENSION	TOLERANCE
BELOW 10 mm	± 0.3
10~100 mm	± 0.5
ABOVE 100 mm	± 0.8
ANGLE	± 3°

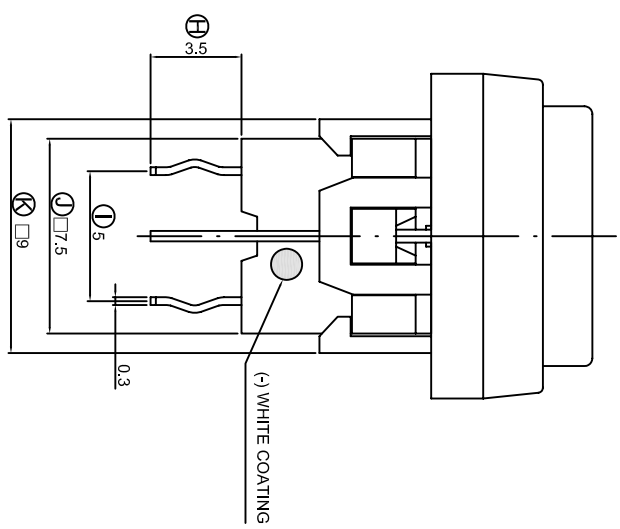
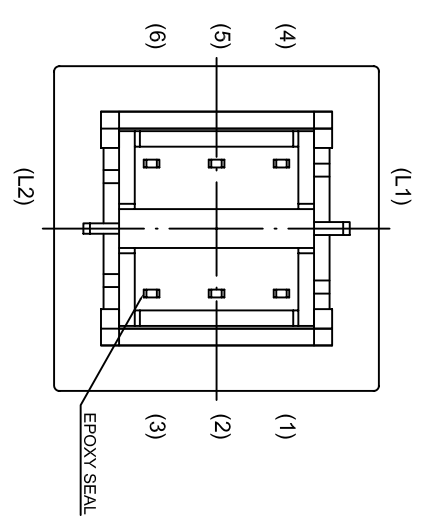
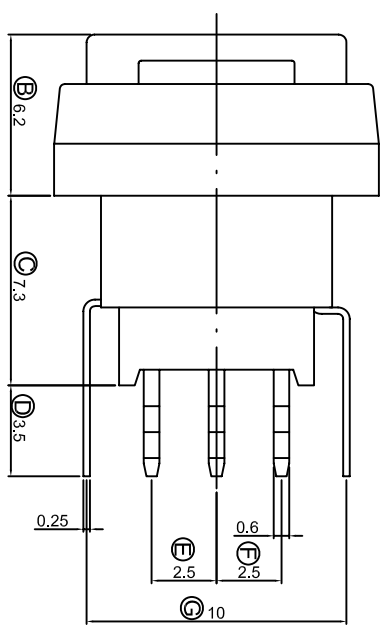
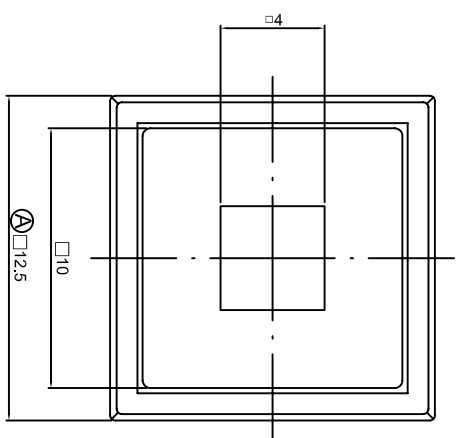

**CIRCUIT DIAGRAMS**

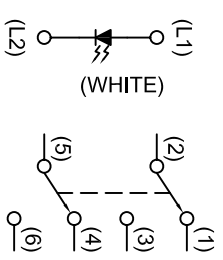

**PCB LAYOUT**

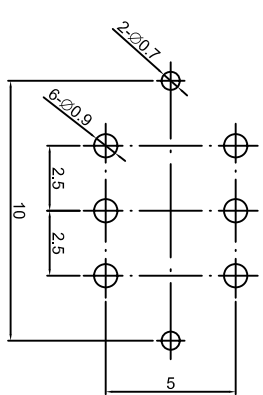

1. 2P2T , LOCK TYPE .
2. RATING : 0.1A 30VDC MAX ; 0.1mA 5VDC MIN .
3. CONTACT RESISTANCE : 50 mΩ MAX .
4. INSULATION RESISTANCE : 500 V DC , 100 MΩ MIN .
5. OPERATING TEMPERATURE : -20°C ~ 70°C .
6. OPERATING FORCE : 250± 100 gf .
7. OPERATING LIFE : 50,000 CYCLES .
8. CRITICAL DIMENSIONS : 'A' ~ 'K' .

DATE	APPROVAL	DESIGN	ENGINEERING CHANGE DESCRIPTION	DATE	UNIT	MODE	PUSHBUTTON SWITCH WITH LED		
				2014/04/17	mm				
				APPROVAL	KAVEN	SCALE	1 : 1	PART	PS004-L22NPS2HKKUWXX
				CONFIRM	TERENCE	VIEW		2D FILE NAME	PS004-L22NPS2HKKUWXX
				DESIGN	BRILLY	VER.	01	3D FILE NAME	

## SPECIFICATIONS OF PS004 SERIES

### PUSH BUTTON SWITCH

1. POLE - POSITION : DPDT
2. OPERATING TEMPERATURE RANGE : -20°C ~ 70°C
3. RATING : 0.1A 30 VDC Max / 0.1mA 5 VDC Min .
4. ELECTRICAL PERFORMANCE

	ITEM	TEST CONDITIONS	CRITERIA
4-1	CONTACT RESISTANCE	DC 1.5V 100 mA , BY METHOD OF VOLTAGE DROP.	50 mΩ MAX.
4-2	INSULATION RESISTANCE	DC 500V	100 MΩ MIN.
4-3	DIELECTRIC STRENGTH	AC 500V FOR 1 MINUTE	BREAKDOWN IS NOT ALLOWABLE

#### 5. MECHANICAL PERFORMANCE

	ITEM	TEST CONDITIONS	CRITERIA
5-1	OPERATING FORCE	ALONG THE DIRECTION TO APPLY A STATIC LOAD AT END OF ACTUATOR.	250±100 gf
5.2	TRAVEL	1. FULL TRAVEL 2. CONTACT TRAVEL	1. 1.5 ± 0.3 mm 2. 0.7 ± 0.3 mm
5-3	SOLDERABILITY	260±5°C IN 3 SECONDS	SOLDER COVERAGE 75% MIN.

#### 6. SOLDERING HEAT RESISTANCE

- 6.1 MANUAL: 300±5°C IN 3 SECONDS.
- 6.2 WAVE SOLDERING: 260±5°C IN 3 SECONDS.

## 7. DURABILITY:

OPERATING LIFE WITH LOAD AFTER 50,000 CYCLES AT SPEED 15 ~ 20 CYCLES / MINUTE, 1.5 VDC 100 mA RESISTANCE LOAD , AFTER THAT THE SWITCH SHOULD MEET FOLLOWING SPECIFICATIONS.

7.1 CONTACT RESISTANCE : 100 m $\Omega$  MAX.

7.2 OPERATING FORCE : WITHIN THE RANGE  $\pm 30\%$  OF SPECIFICATION.

7.3 INSULATION RESISTANCE : 500V DC 100 M $\Omega$  MIN.

7.4 DIELECTRIC STRENGTH : 500V AC FOR 1 MINUTE, BREAKDOWN IS NOT ALLOWABLE.

## 8. ENVIRONMENTAL PERFORMANCE

	ITEM	TEST CONDITIONS	CRITERIA
8-1	COLD	-20 $\pm 2^{\circ}\text{C}$ FOR 96 HOURS	1. SWITCH SHOULD MEET REQUIREMENTS OF ITEM 4. 2. MECHANICAL PERFORMANCE SHOULD REMAIN TO NORMAL.
8-2	DRY HEAT	70 $\pm 2^{\circ}\text{C}$ FOR 96 HOURS	1. SWITCH SHOULD MEET REQUIREMENTS OF ITEM 4. 2. MECHANICAL PERFORMANCE SHOULD REMAIN TO NORMAL.
8-3	DAMP HEAT	40 $\pm 2^{\circ}\text{C}$ 90% ~ 95% RH FOR 96 HOURS	1. SWITCH SHOULD MEET REQUIREMENTS OF ITEM 4. 2. MECHANICAL PERFORMANCE SHOULD REMAIN TO NORMAL.

## 9. LED SPECIFICATIONS

LED SPECIFICATIONS WILL BE FURNISHED DEPENDING ON DIFFERENT LED COLOR DEMAND.

# SUBMINIATURE SOLID STATE LAMP

## PRELIMINARY SPEC

Part Number: KM-26APWF-A-01-WBY-DOTB White



**ATTENTION**  
OBSERVE PRECAUTIONS  
FOR HANDLING  
ELECTROSTATIC  
DISCHARGE  
SENSITIVE  
DEVICES

### Features

- Subminiature package.
- Wide viewing angle.
- Long life-solid state reliability.
- Low package profile.
- Moisture sensitivity level : level 3.
- RoHS compliant.

### Description

The source color devices are made with InGaN on SiC Light Emitting Diode.

Static electricity and surge damage the LEDs.

It is recommended to use a wrist band or anti-electrostatic glove when handling the LEDs.

All devices, equipment and machinery must be electrically grounded.

### Package Dimensions

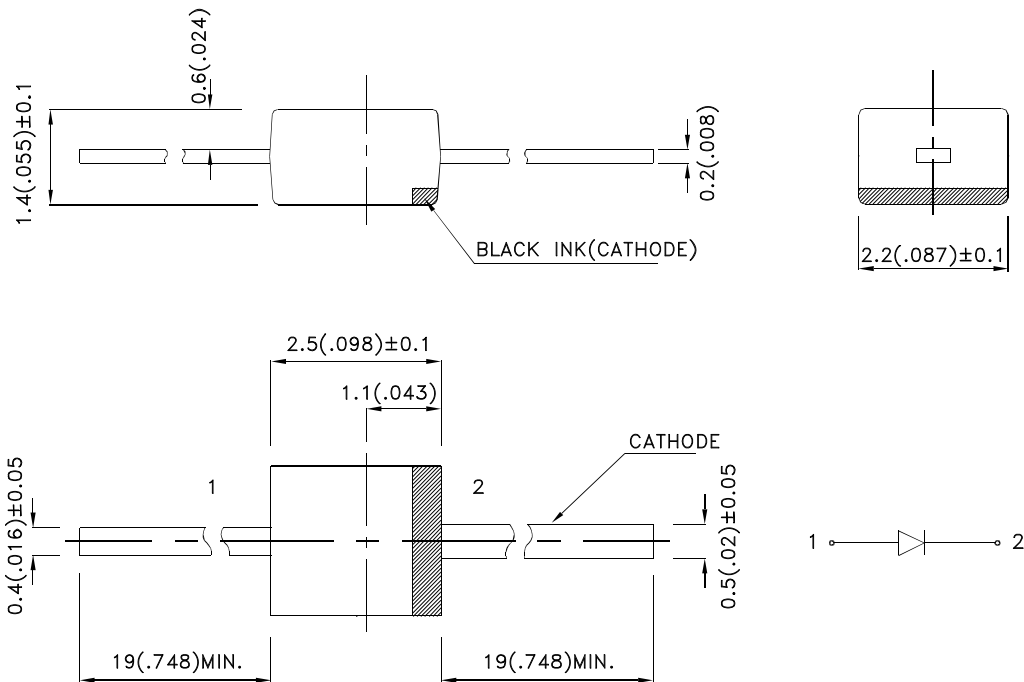

#### Notes:

1. All dimensions are in millimeters (inches).
2. Tolerance is  $\pm 0.25(0.01)$ " unless otherwise noted.
3. Lead spacing is measured where the leads emerge from the package.
4. Specifications are subject to change without notice.



## Selection Guide

Part No.	Dice	Lens Type	Iv (mcd) [2] @ 20mA		Viewing Angle [1]
			Min.	Typ.	2 $\theta$ 1/2
	White (InGaN)	YELLOW FLUORESCENT	110	250	140°

Notes:

1.  $\theta$ 1/2 is the angle from optical centerline where the luminous intensity is 1/2 the optical centerline value.
2. Luminous intensity/ luminous Flux: +/-15%.

## Electrical / Optical Characteristics at TA=25°C

Symbol	Parameter	Device	Typ.	Max.	Units	Test Conditions
V <sub>F</sub> [1]	Forward Voltage	White	3.2	4.0	V	I <sub>F</sub> =20mA
I <sub>R</sub>	Reverse Current	White		10	uA	V <sub>R</sub> = 5V
x [2]	Chromaticity Coordinates	White	0.31			
y [2]			0.31			
C	Capacitance	White	100		pF	V <sub>F</sub> =0V;f=1MHz

Notes:

1. Forward Voltage: +/-0.1V.
2. Measurement tolerance of the chromaticity coordinates is  $\pm$ 0.01.

## Absolute Maximum Ratings at TA=25°C

Parameter	White	Units
Power dissipation	120	mW
DC Forward Current	30	mA
Peak Forward Current [1]	100	mA
Reverse Voltage	5	V
Operating/Storage Temperature	-40°C To +85°C	
Lead Solder Temperature [2]	260°C For 3 Seconds	
Lead Solder Temperature [3]	260°C For 5 Seconds	

Notes:

1. 1/10 Duty Cycle, 0.1ms Pulse Width.
2. 2mm below package base.
3. 5mm below package base.

**White**

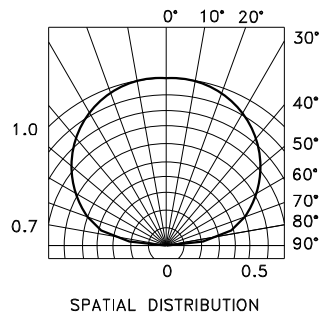
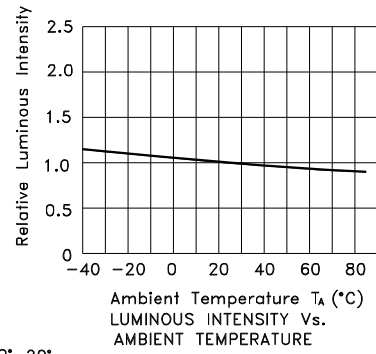
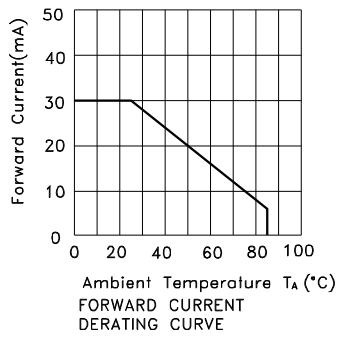
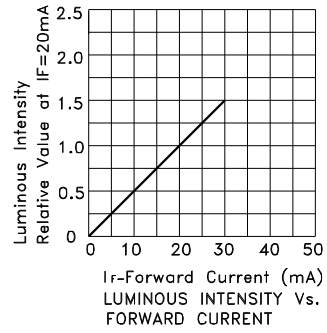
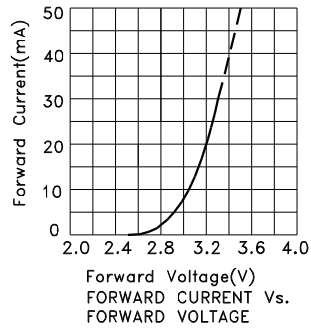

### White CIE

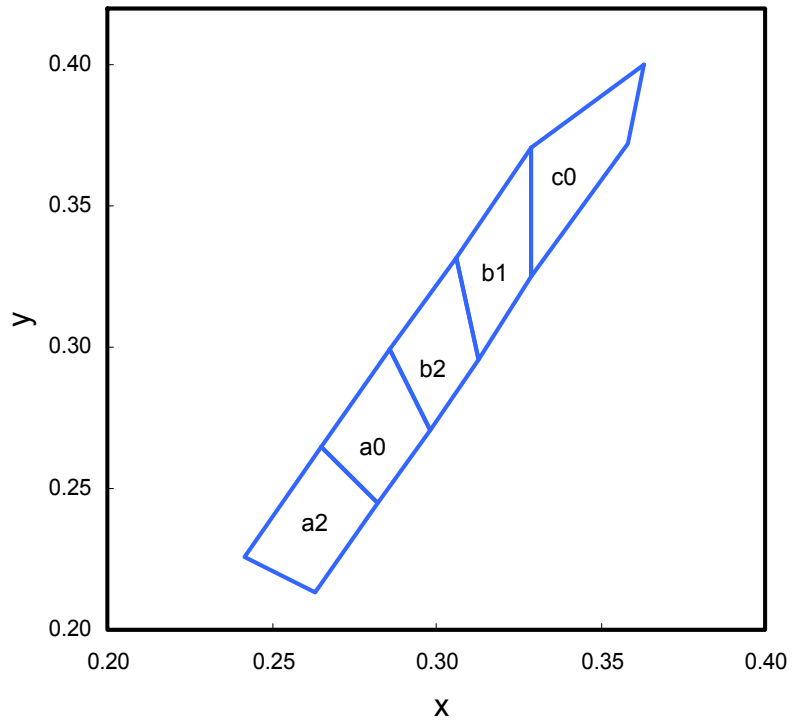

Rank a2				
x	0.263	0.282	0.265	0.242
y	0.213	0.245	0.265	0.226

Rank a0				
x	0.282	0.298	0.286	0.265
y	0.245	0.271	0.299	0.265

Rank b2				
x	0.298	0.313	0.306	0.286
y	0.271	0.296	0.332	0.299

Rank b1				
x	0.313	0.329	0.329	0.306
y	0.296	0.325	0.371	0.332

Rank c0				
x	0.329	0.358	0.363	0.329
y	0.325	0.372	0.400	0.371



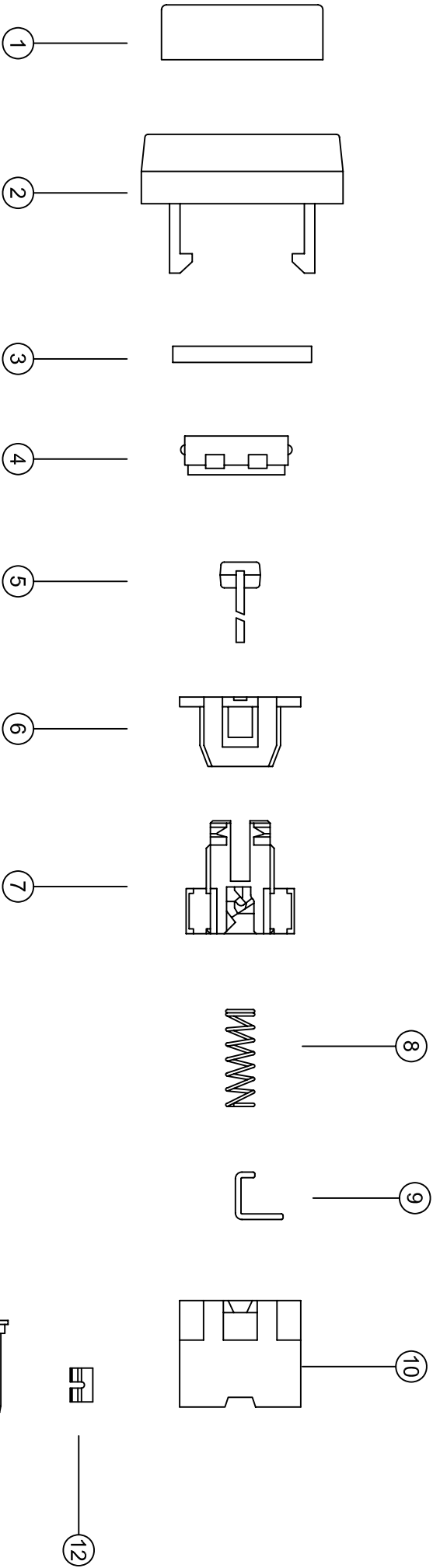

NO.	PART NAME	QTY	MATERIAL	SPECIAL DEAL	RoHS REPORT No.
1	LED COVER	1	PC-143R111	BLACK	TWNC00277207S1
2	KNOB FRAME	1	PA66+33%GF	BLACK	CE/2014/25430; CANEC1403097001
3	FLUORESCENT PLATE	1	PC-143R111	WHITE TRANSPARENT	TWNC00277207S1
4	KNOB	1	PA66+33%GF	WHITE	CE/2014/25430; CANEC1311693101; CANEC1311693102
5	LED	1		ULTRA WHITE	SZHH0084529102S1; SZHH00853916
6	COVER	1	PA66+33%G	BLACK	CE/2014/25430; CANEC1403097001
7	ACTUATOR	1	PA66+33%G	WHITE	CE/2014/25430; CANEC1311693101; CANEC1311693102
8	SPRING	1	STAINLESS STEEL		F690101-L-F-CTSA YAA14-03884
9	LOCK PIN	1	STAINLESS STEEL		CE/2013/70869A
10	BASE FRAME	1	PA66+33%G	BLACK	CE/2014/25430; CANEC1403097001
11	BOARD WITH TERMINAL	2	PA66+33%G	BLACK	CE/2014/25430; CANEC1403097001
12	CLIP	2	PHOSPHOR BRONZE	SILVER CLAD	CE/2014/11747; CANEC1401599601
13	TERMINAL	2	BRASS	SILVER PLATING	CE/2014/11738; CANEC1401599601

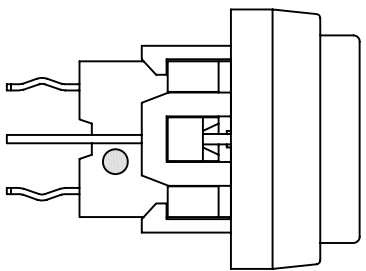

DATE	APPROVAL	DESIGN	ENGINEERING CHANGE DESCRIPTION	DESIGN	BRULLY	VER.	01	3D FILE NAME	
				DATE	2014/04/17	UNIT	mm	MODE	PUSHBUTTON SWITCH WITH LED
				APPROVAL	KAVEN	SCALE	1:1	PART	PS004L22NP52HKKUWXX
				CONFIRM	TERENCE	VIEW		2D FILE NAME	PS004L22NP52HKKUWXX
				DESIGN		VER.		MATERIAL LIST	