

APPROVAL SHEET

DESCRIPTION: PUSH BUTTON SWITCH LED

PART NO: PS004-N22NPS2HKKUGXX

CUSTOMER: MARUTSU _____	CUSTOMER'S PART NO: _____
CUSTOMER SIGNATURE	COMMENTS

APPROVAL	REVIEW	PREPARE
<i>Kaven</i>	<i>Tereance</i>	<i>Gina</i>

DIMENSION	TOLERANCE
BELOW 10 mm	± 0.3
10~100 mm	± 0.5
ABOVE 100 mm	± 0.8
ANGLE	± 3°

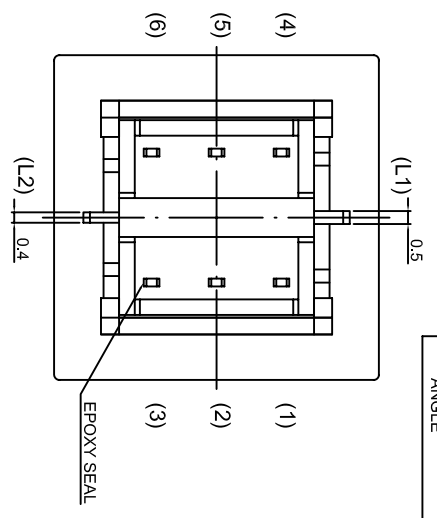
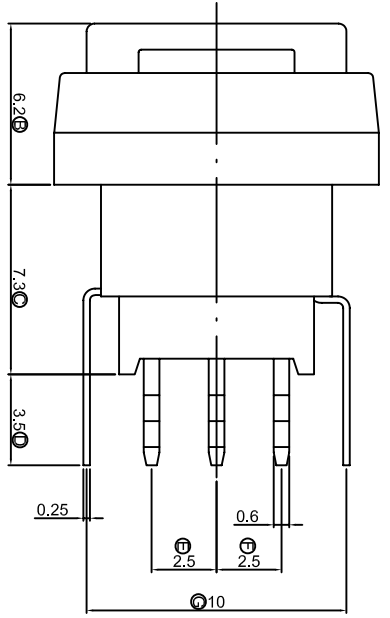
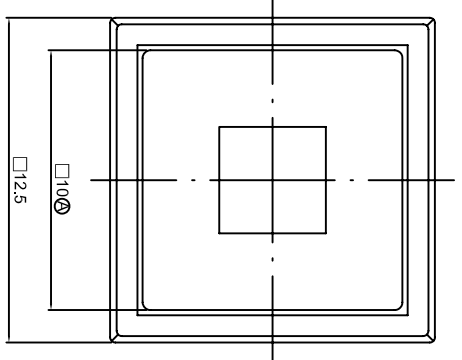

CIRCUIT DIAGRAMS

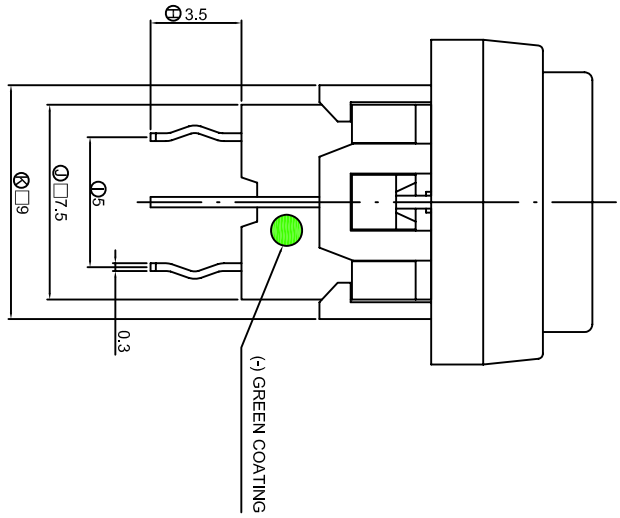
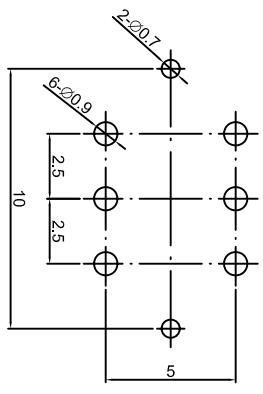
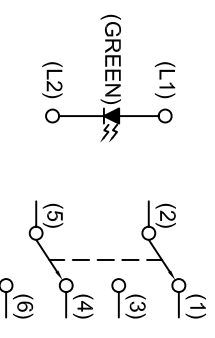

1. 2P2T , NON-LOCK TYPE .
2. RATING : 0.1A 30VDC MAX ; 0.1mA 5VDC MIN .
3. CONTACT RESISTANCE : 50 mΩ MAX .
4. INSULATION RESISTANCE : 500 V DC , 100 MΩ MIN .
5. OPERATING TEMPERATURE : -20°C ~ 70°C .
6. OPERATING FORCE : 250±100 gf .
7. OPERATING LIFE : 50,000 CYCLES .
8. CRITICAL DIMENSIONS : 'A' ~ 'K' .

DATE	UNIT	MODE	PUSHBUTTON SWITCH WITH LED
2008/1/1/17	mm	PART	PS004-N22NPS2HKKUGXX
APPROVAL	SCALE	2D FILE NAME	PS004-N22NPS2HKKUGXX
CONFIRM	VIEW	3D FILE NAME	
ANDY	VER.		
01			

SPECIFICATIONS OF PS004 SERIES

PUSH BUTTON SWITCH

1. POLE - POSITION : DPDT
2. OPERATING TEMPERATURE RANGE : -20°C ~ 70°C
3. RATING : 0.1A 30 VDC Max / 0.1mA 5 VDC Min .
4. ELECTRICAL PERFORMANCE

	ITEM	TEST CONDITIONS	CRITERIA
4-1	CONTACT RESISTANCE	DC 1.5V 100 mA , BY METHOD OF VOLTAGE DROP.	50 mΩ MAX.
4-2	INSULATION RESISTANCE	DC 500V	100 MΩ MIN.
4-3	DIELECTRIC STRENGTH	AC 500V FOR 1 MINUTE	BREAKDOWN IS NOT ALLOWABLE

5. MECHANICAL PERFORMANCE

	ITEM	TEST CONDITIONS	CRITERIA
5-1	OPERATING FORCE	ALONG THE DIRECTION TO APPLY A STATIC LOAD AT END OF ACTUATOR.	250±100 gf
5.2	TRAVEL	1. FULL TRAVEL 2. CONTACT TRAVEL	1. 1.5 ± 0.3 mm 2. 0.7 ± 0.3 mm
5-3	SOLDERABILITY	245±5°C IN 5 SECONDS	SOLDER COVERAGE 75% MIN.

6. SOLDERING HEAT RESISTANCE

- 6.1 MANUAL: 300±5°C IN 3 SECONDS.
- 6.2 WAVE SOLDERING: 260±5°C IN 3 SECONDS.

7. DURABILITY:

OPERATING LIFE WITH LOAD AFTER 50,000 CYCLES AT SPEED 15 ~ 20 CYCLES / MINUTE, 1.5 VDC 100 mA RESISTANCE LOAD , AFTER THAT THE SWITCH SHOULD MEET FOLLOWING SPECIFICATIONS.

7.1 CONTACT RESISTANCE : 100 m Ω MAX.

7.2 OPERATING FORCE : WITHIN THE RANGE $\pm 30\%$ OF SPECIFICATION.

7.3 INSULATION RESISTANCE : 500V DC 100 M Ω MIN.

7.4 DIELECTRIC STRENGTH : 500V AC FOR 1 MINUTE, BREAKDOWN IS NOT ALLOWABLE.

8. ENVIRONMENTAL PERFORMANCE

	ITEM	TEST CONDITIONS	CRITERIA
8-1	COLD	-20 $\pm 2^{\circ}\text{C}$ FOR 96 HOURS	1. SWITCH SHOULD MEET REQUIREMENTS OF ITEM 4. 2. MECHANICAL PERFORMANCE SHOULD REMAIN TO NORMAL.
8-2	DRY HEAT	70 $\pm 2^{\circ}\text{C}$ FOR 96 HOURS	1. SWITCH SHOULD MEET REQUIREMENTS OF ITEM 4. 2. MECHANICAL PERFORMANCE SHOULD REMAIN TO NORMAL.
8-3	DAMP HEAT	40 $\pm 2^{\circ}\text{C}$ 90% ~ 95% RH FOR 96 HOURS	1. SWITCH SHOULD MEET REQUIREMENTS OF ITEM 4. 2. MECHANICAL PERFORMANCE SHOULD REMAIN TO NORMAL.

9. LED SPECIFICATIONS

LED SPECIFICATIONS WILL BE FURNISHED DEPENDING ON DIFFERENT LED COLOR DEMAND.

SUBMINIATURE SOLID STATE LAMP

Part Number:

Mega Green

Features

- Subminiature package.
- Wide viewing angle.
- Long life-solid state reliability.
- Low package profile.
- Moisture sensitivity level : level 3.
- RoHS compliant.

Description

The Mega Green source color devices are made with Al-GaN on GaAs substrate Light Emitting Diode.

Package Dimensions

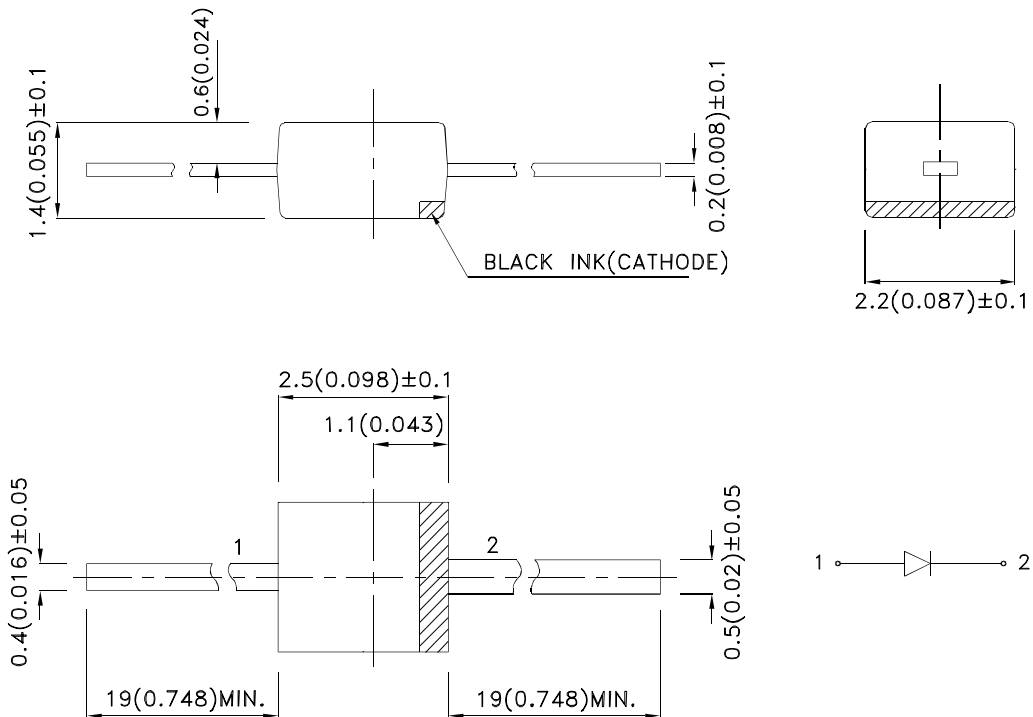

Notes:

1. All dimensions are in millimeters (inches).
2. Tolerance is $\pm 0.25(0.01)$ " unless otherwise noted.
3. Lead spacing is measured where the leads emerge from the package.
4. The specifications, characteristics and technical data described in the datasheet are subject to change without prior notice.



Selection Guide

Part No.	Dice	Lens Type	Iv (mcd) [2] @ 20mA			Viewing Angle [1]
			Min.	Typ.	Max.	2θ1/2 .
	Mega Green (AlGaInP)	Water Clear	20	55	100	140°

Notes:

1. θ1/2 is the angle from optical centerline where the luminous intensity is 1/2 of the optical peak value.
2. Luminous intensity/ luminous Flux: +/-15%.

Electrical / Optical Characteristics at TA=25°C

Symbol	Parameter	Device	Min.	Typ.	Max.	Units	Test Conditions
λ _{peak}	Peak Wavelength	Mega Green		574		nm	I _F =20mA
λ _D [1]	Dominant Wavelength	Mega Green	561	567	571	nm	I _F =20mA
Δλ _{1/2}	Spectral Line Half-width	Mega Green		20		nm	I _F =20mA
C	Capacitance	Mega Green		15		pF	V _F =0V;f=1MHz
V _F [2]	Forward Voltage	Mega Green	1.6	2.1	2.5	V	I _F =20mA
I _R	Reverse Current	Mega Green			10	uA	V _R = 5V

Notes:

- 1.Wavelength: +/-1nm.
2. Forward Voltage: +/-0.1V.

Absolute Maximum Ratings at TA=25°C

Parameter	Mega Green	Units
Power dissipation	75	mW
DC Forward Current	30	mA
Peak Forward Current [1]	150	mA
Reverse Voltage	5	V
Electrostatic Discharge Threshold (HBM)	3000	V
Operating/Storage Temperature	-40°C To +85°C	
Lead Solder Temperature [2]	260°C For 3 Seconds	
Lead Solder Temperature [3]	260°C For 5 Seconds	

Notes:

1. 1/10 Duty Cycle, 0.1ms Pulse Width.
2. 2mm below package base.
3. 5mm below package base.

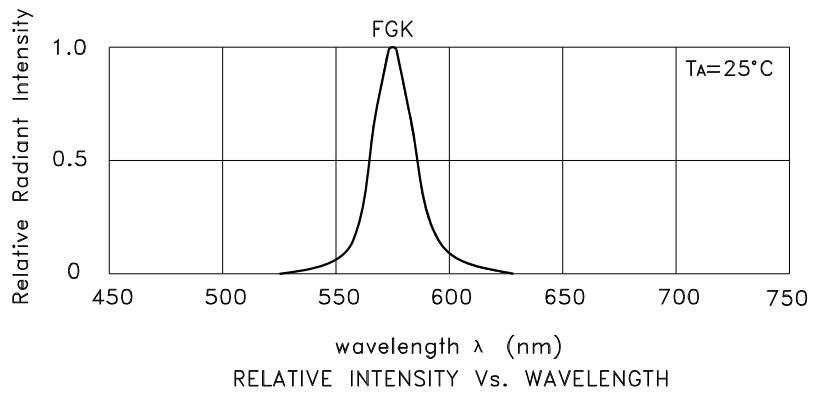

Mega Green

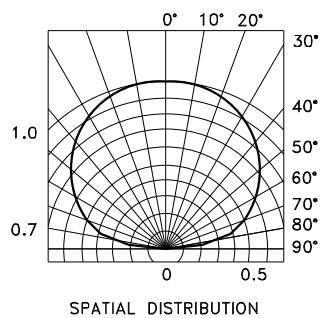
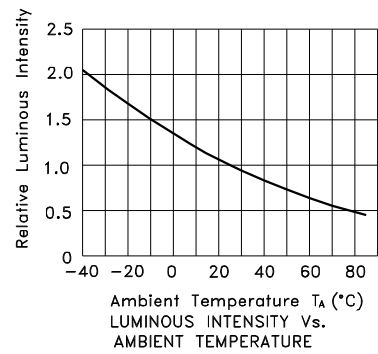
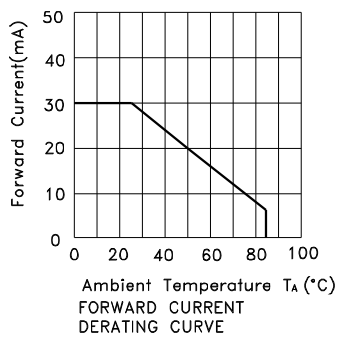
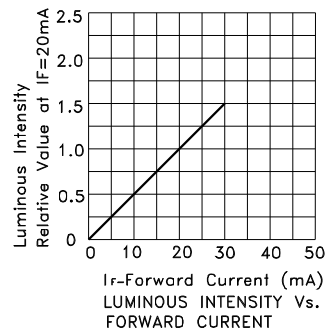
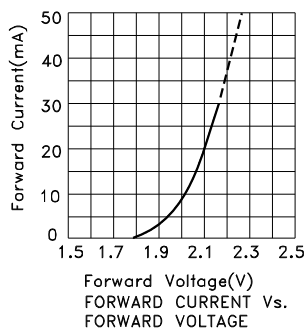

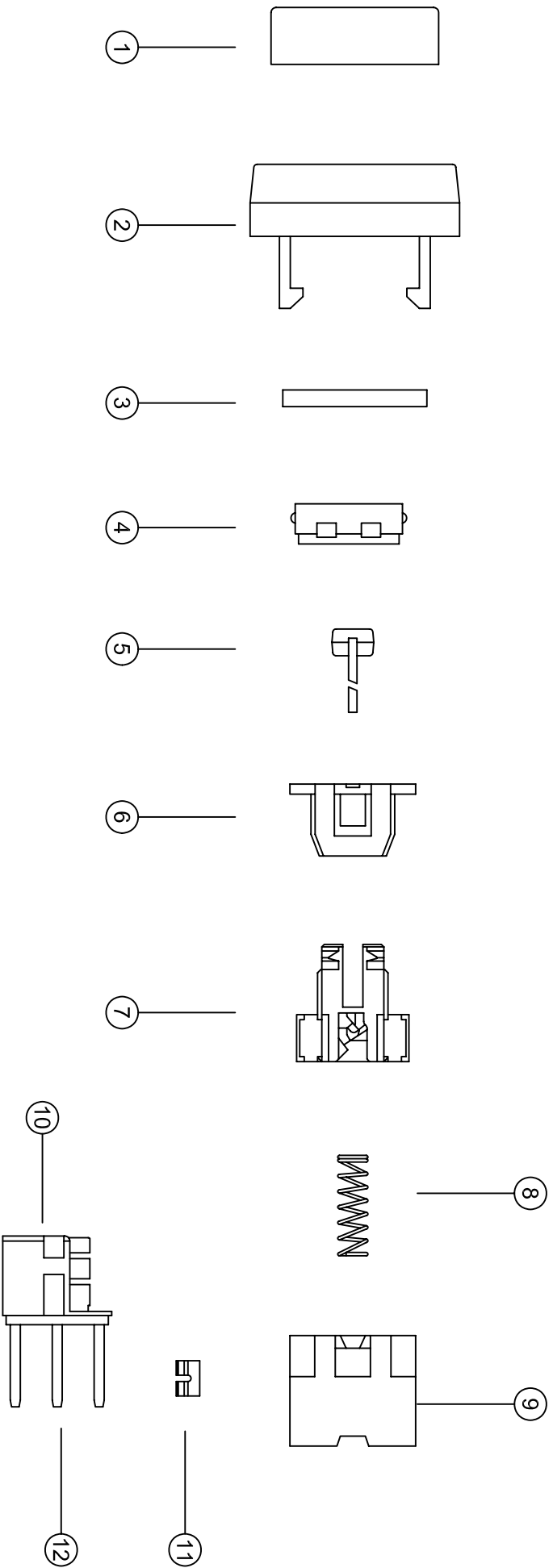

NO.	PART NAME	QTY	MATERIAL	SPECIAL DEAL	ROHS REPORT No.
1	LED COVER	1	PC-143R111	BLACK	TWNC00277207S1
2	KNOB FRAME	1	PA66+33%GF	BLACK	CE/2014/25430; CANEC1403097001
3	FLUORESCENT PLATE	1	PC-143R111	WHITE TRANSPARENT	TWNC00277207S1
4	KNOB	1	PA66+33%GF	WHITE	CE/2014/25430; CANEC1311693101; CANEC1311693102
5	LED	1		ULTRA GREEN	SZH0084529102S1; SZHH00853916
6	COVER	1	PA66+33%G	BLACK	CE/2014/25430; CANEC1403097001
7	ACTUATOR	1	PA66+33%G	WHITE	CE/2014/25430; CANEC1311693101; CANEC1311693102
8	SPRING	1	STAINLESS STEEL		F690101-LF-C-TSAYAA14-03884
9	BASE FRAME	1	PA66+33%G	BLACK	CE/2014/25430; CANEC1403097001
10	BOARD WITH TERMINAL	2	PA66+33%G	BLACK	CE/2014/25430; CANEC1403097001
11	CLIP	2	PHOSPHOR BRONZE	SILVER CLAD	CE/2014/11747; CANEC1401599601
12	TERMINAL	2	BRASS	SILVER PLATING	CE/2014/11738; CANEC1401599601

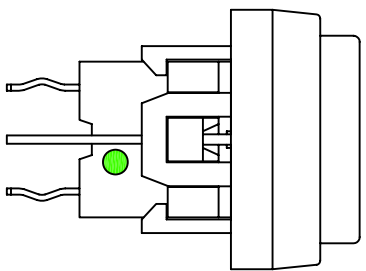

DATE	APPROVAL	DESIGN	ENGINEERING CHANGE DESCRIPTION	DESIGN	ANDY	VER.	01	3D FILE NAME	
				DATE	2010/01/19	UNIT	mm	MODE	PUSHBUTTON SWITCH WITH LED
				APPROVAL	KAIVEN	SCALE	1:1	PART	PS004-N22NP52HKKUGXX
				CONFIRM	ALAN	VIEW		2D FILE NAME	PS004-N22NP52HKKUGXX MATERIAL LIST