

Rating	10A 125V, 6A 250V AC 		
Contact Resistance	50m ohm Max.		
Insulation Resistance	DC 500V 100M ohm Min.		
Dielectric Strength	AC 1000V 1 minute		
Switch Function	3P SPDT ON-ON		

1 HEX NUT ASSY  
 1 SPRING WASHER ASSY  
 1 KNURL NUT ASSY

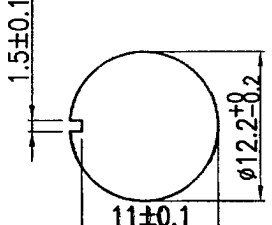
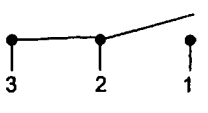
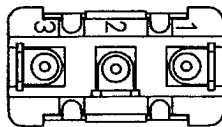
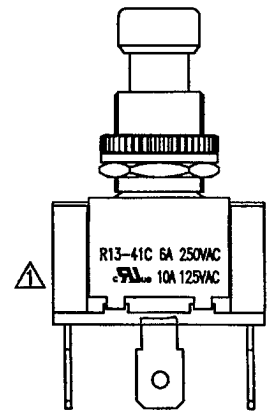
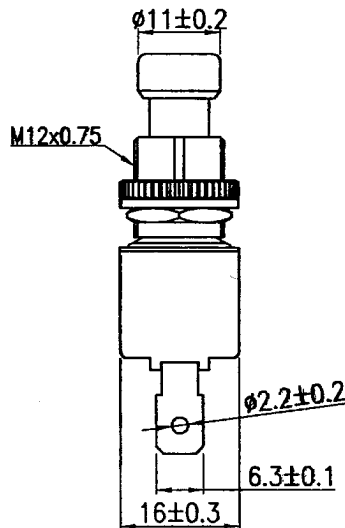
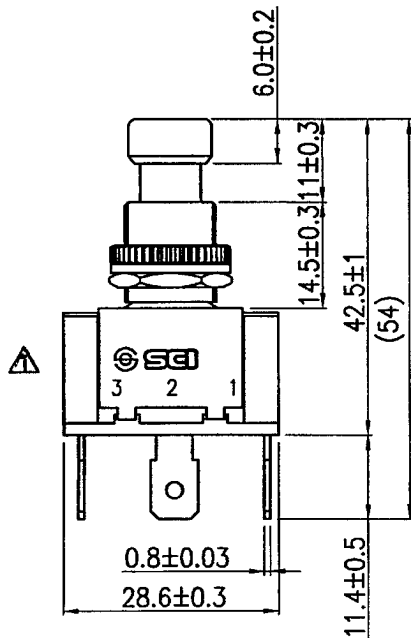
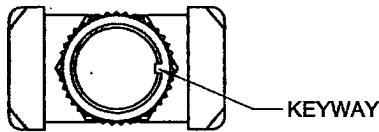
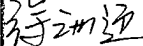
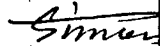

09/25/13	柳新強								△
Date	Name	Description						No.	△
Drawn	Checked	Approved	SCI BOM No.	1830687	Model Name	PUSH SWITCH			
柳新強			Customer No.		Model No.	R13-41C	Rev.	1	
09/25/13	9/25-13	9/25-13	Unit	mm					