

12mm Square TACT Switch (Snap-in) SKHC Series

Details

Product No.	Type	Operating force	Operating direction	Travel	Operating life (5mA 5V DC)	Initial contact resistance	Stem color	Variety	Minimum packing unit (pcs.)
SKHCAEA010	Snap-in	0.74N	Vertical	0.3mm	500,000 cycles	100mΩ max.	Blue	Joint stem	1,000

Products Specifications

Series type	Operating temperature range	Rating (max.)	Rating (min.)	Electrical performance	
				Insulation resistance	Voltage proof
Sharp feeling type	-20° C to +70° C	50mA 12V DC	10μA 1V DC	100MΩmin. 100V DC	250V AC for 1min.

Durability	Environmental test		
Vibration	Cold	Dry heat	Damp heat
10 to 55 to 10Hz/min., the amplitude is 1.5mm for all the frequencies, in the 3 direction of X, Y and Z and for 2 hours respectively	-30±2° C for 96h	80±2° C for 96h	60±2° C, 90 to 95%RH for 96h

1. Place your purchase order in N minimum package units (N: integer).
2. Ask us for the export packaging unit.
3. Using a 1.6mm thick PC board is recommended.

Dimensions

Joint stem type

Unit : mm

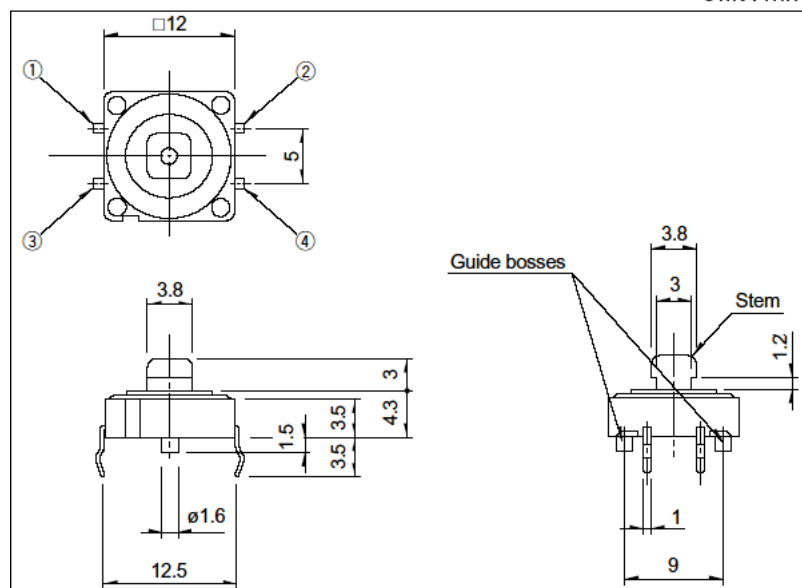

■ PC board Mounting Hole Dimensions
(Viewed from Mounting Face)

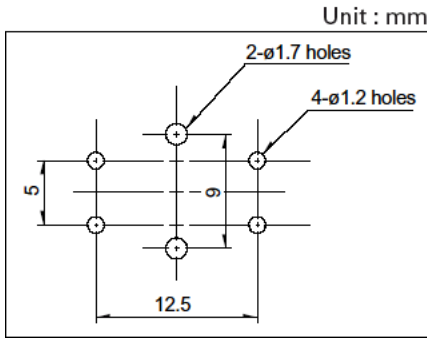

■ Circuit Diagram

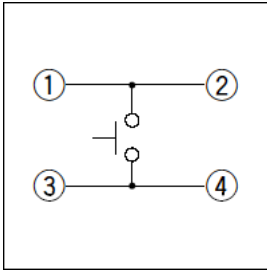

■ Soldering Conditions

Conditions for Auto-dip

Items	Condition
Flux built-up	Mounting surface should not be coated with flux
Preheating temperature	Ambient temperature of the soldered surface of PC board. 100°C max.
Preheating time	45s max.
Soldering temperature	255°C max.
Continuous dipping time	5s max.
Number of soldering	2times max.

Manual Soldering

Items	Condition
Soldering temperature	350°C max.
Continuous soldering time	3s max.

CAUTION

1. Consult with us for TACT switch washing conditions.
2. Prevent flux penetration from the top side of the TACT switch.
3. Switch terminals and a PC board should not be coated with flux prior to soldering.
4. The second soldering should be done after the switch returns to normal temperature.
5. Use the flux with a specific gravity of at least 0.83.
(MH-820V or CF220V by TAMURA Corporation, or their equivalents.)

Products Line of Knob

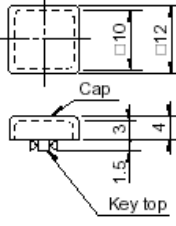
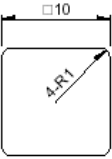
Dimensions (Unit: mm)	Cap		Keytop		Keytop + Cap		Label dimensions (Unit: mm)
	Color	Model	Color	Model	Color	Model	
 	Clear	SK2AA00510	Red SK2AA00010 Blue SK2AA00020 Ivory SK2AA00030 Black SK2AA00040 Yellow SK2AA00050	Red SK2AA00060 Blue SK2AA00070 Ivory SK2AA00080 Black SK2AA00090 Yellow SK2AA00100			 <p>Thickness 0.1</p>

- **Notes**
1. The knob will be delivered with the switch, unmounted.
 2. The label is not included.
 3. For SK2AA00010 to SK2AA00100 type, check its mounting direction.

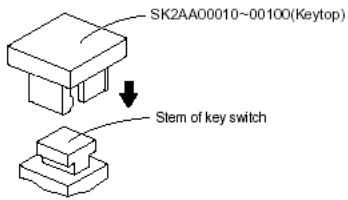

Caution

1. Note that terminals might suffer deformation of the switch and the defects in electrical performance, if the load is applied to the terminals during soldering.
2. If you use a through-hole PC board or a PC board thinner or thicker than the recommendation, there may be greater heat stress. Verify the soldering conditions thoroughly before use.
3. When soldering twice, wait until the first soldered portion cools to normal temperature. Continuous heating will deform the external portions, loosen or dislodge terminals, or may deteriorate their electrical characteristics.
4. Verify soldering conditions under actual mass production conditions.
5. This product is designed and manufactured assuming that it is to be used with the resistance for direct current. If you use other kinds of resistance [inductive (L) or capacitive (C)], consult with us beforehand.
6. For the sizes of holes and patterns on a PC board for mounting a switch, refer to the recommended dimensions in the outline drawings.
7. This switch is designed for manually operated units. Do not use this switch in a mechanical detection unit. For detection purposes, please use our detection switch.
8. The switch will break if you apply a greater stress than that specified. Take great care not to let the switch be subject to greater stress than specified.
9. Do not press the side of the stem.
10. Be sure to push the center position of a flat stem switch. Extreme care is required for a hinge structure type because the stem press position moves when it is pressed.
11. If you put the board with the switch in the oven so as to harden adhesive for other parts, consult with us.
12. When corrosive gas is generated by a peripheral material of a product using the TACT switch, malfunctions such as imperfect contacts can occur. Check this point thoroughly in advance.
13. The contact resistance of a rubber contact type changes depending on pressure load. Confirm that it functions sufficiently when you use this TACT switch with a voltage divider circuit.
14. Be aware of dust intrusion into an unsealed-type TACT switch.
15. Storage method
 - (1) If you do not use the product immediately, store it just as delivered in the following environment : with neither direct sunshine nor corrosive gas and in normal temperatures. However, it is recommended that you should use it as soon as possible or within six months from the date of delivery at the most.
 - (2) After you break the seal, you should put the remainder in a plastic bag to shut out outside air, and store it in the same environment mentioned above. You should use it up as soon as possible.
 - (3) Do not stack too many switches for safety.
 - (4) Store the key switches with the switch in the released position.

Measurement and Test Methods

[Rotational Torque (Operating Force)]

Measures the torque (operating force) necessary to rotate (move) the shaft (lever) . Unless otherwise specified, measurement shall be made at ambient temperature of 5 to 35° C, the shaft rotational speed shall be 60° per second, and the lever traveling speed shall be 20mm per second.

[Withstand Voltage]

Applies AC voltage to the specified spot for a minute and then checks for arc, burning, dielectric breakdown and other abnormalities. Respective terminals may be tested as a group. The sections described below shall be tested unless otherwise specified. However, if the section concerned is so constructed as to conduct, that particular part shall not be tested.

[Insulation Resistance]

Applies specified voltage to the specified locations and then measures the insulation resistance with a megger. The locations described below shall be tested unless otherwise specified. However, if the section concerned is so constructed as to conduct, that particular part shall not be tested.

[Sections to be Tested for Withstand Voltage and Insulation Resistance]

- Between terminal and shaft(lever).
- Between terminal and metal cover(frame).

[Shaft (Lever) Strength against Push/Pull Actions]

Applies a specified force in the axial direction of the shaft (lever) for 10 seconds and then checks the operating part and other sections for deformation, breakage, operating condition, etc.