

## Turbo 2 ultrafast high voltage rectifier

Datasheet - production data

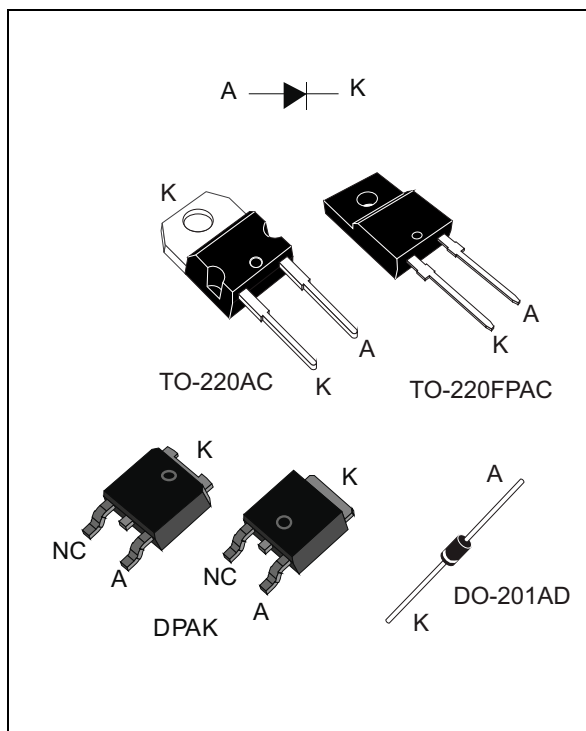

### Description

The STTH5L06 is developed using St's Turbo 2 600 V technology. It is well-suited as a boost diode, especially for use in continuous mode power factor corrections and hard switching conditions. This device is also intended for use as a free wheeling diode in power supplies and other power switching applications.

**Table 1. Device summary**

Symbol	Value
$I_{F(AV)}$	5 A
$V_{RRM}$	600 V
$I_R(max)$	125 $\mu$ A/ 150 $\mu$ A
$T_J(max)$	175 °C
$V_F$ (typ)	0.85 V
$t_{rr}$ (typ)	65 ns

### Features

- Ultrafast switching
- Low reverse recovery current
- Reduces switching losses
- Low thermal resistance
- Insulated package: TO-220FPAC
  - Insulation voltage: 2000  $V_{RMS}$  sine
- ECOPACK<sup>®</sup>2 compliant component for DPAK on demand

# 1 Characteristics

**Table 2. Absolute ratings (limiting values at 25 °C unless otherwise specified)**

Symbol	Parameter		Value	Unit	
$V_{RRM}$	Repetitive peak reverse voltage		600	V	
$I_{F(RMS)}$	Forward rms current	TO-220AC / TO-220FPAC / DO-201AD	20	A	
		DPAK	10		
$I_{F(AV)}$	Average forward current $\delta = 0.5$ , square wave	TO-220AC / DPAK	$T_C = 150\text{ °C}$	A	
		DO-201AD	$T_I = 50\text{ °C}$		
		TO-220FPAC	$T_C = 135\text{ °C}$		
$I_{FRM}$	Repetitive peak forward current		$t_p = 5\ \mu s, F = 5\text{ kHz square}$	65	A
$I_{FSM}$	Surge non repetitive forward current	$t_p = 10\text{ ms}$ sinusoidal	TO-220AC / TO-220FPAC	90	A
			DO-201AD	110	
			DPAK	60	
$T_{stg}$	Storage temperature range		-65 to + 175	°C	
$T_j$	Maximum operating junction temperature		175	°C	

**Table 3. Thermal parameter**

Symbol	Parameter		Value	Unit
$R_{th(j-c)}$	Junction to case	TO-220AC / DPAK	3.5	°C/W
		TO-220FPAC	6	
$R_{th(j-l)}$	Junction to lead	L = 10 m, DO-201AD	20	
$R_{th(j-a)}$	Junction to ambient <sup>(1)</sup>		75	

1. With recommended pad layout (see [Figure 15](#))

**Table 4. Static electrical characteristics**

Symbol	Parameter	Test conditions		Min.	Typ	Max.	Unit
$I_R^{(1)}$	Reverse leakage current	$T_j = 25\text{ °C}$	$V_R = 600\text{ V}$			5	$\mu A$
		$T_j = 150\text{ °C}$	$V_R = 600\text{ V}$	TO-220AC TO-220FPAC DPAK	10	125	
				DO-201AD	25	150	
$V_F^{(2)}$	Forward voltage drop	$T_j = 25\text{ °C}$	$I_F = 5\text{ A}$			1.3	V
		$T_j = 150\text{ °C}$		0.85	1.05		

1. Pulse test:  $t_p = 5\text{ ms}, \delta < 2\%$

2. Pulse test:  $t_p = 380\ \mu s, \delta < 2\%$

To evaluate the maximum conduction losses use the following equation:

$$P = 0.89 \times I_{F(AV)} + 0.033 I_{F(RMS)}^2$$

**Table 5. Dynamic electrical characteristics**

Symbol	Parameter	Test conditions		Min.	Typ	Max.	Unit
$t_{rr}$	Reverse recovery time	$T_j = 25\text{ }^\circ\text{C}$	$I_F = 1\text{ A}$ , $di_F/dt = -50\text{ A}/\mu\text{s}$ , $V_R = 30\text{ V}$		65	95	ns
$t_{fr}$	Forward recovery time	$T_j = 25\text{ }^\circ\text{C}$	$I_F = 5\text{ A}$ , $di_F/dt = 100\text{ A}/\mu\text{s}$ , $V_{FR} = 1.1 \times V_{Fmax}$			150	ns
$V_{FP}$	Forward recovery voltage					7	V

**Figure 1. Conduction losses versus average current**

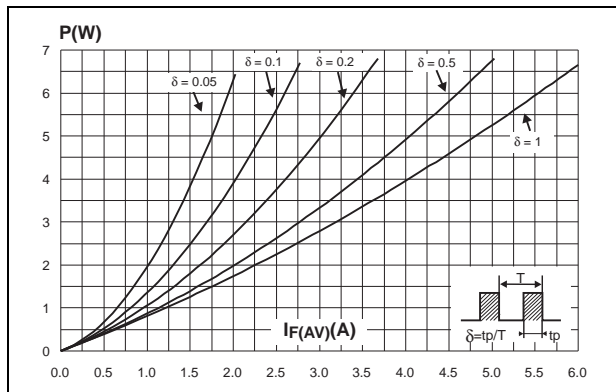

**Figure 2. Forward voltage drop versus forward current**

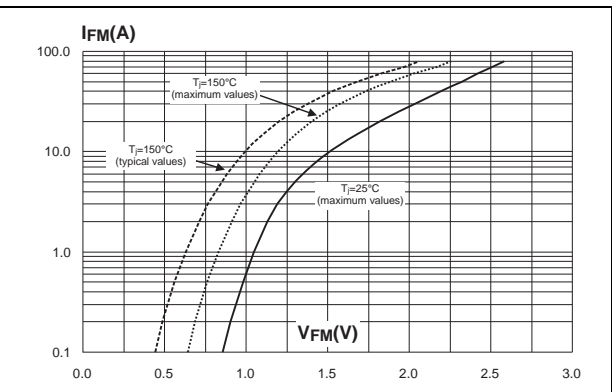

**Figure 3. Relative variation of thermal impedance junction to case versus pulse duration (TO-220AC, DPAK)**

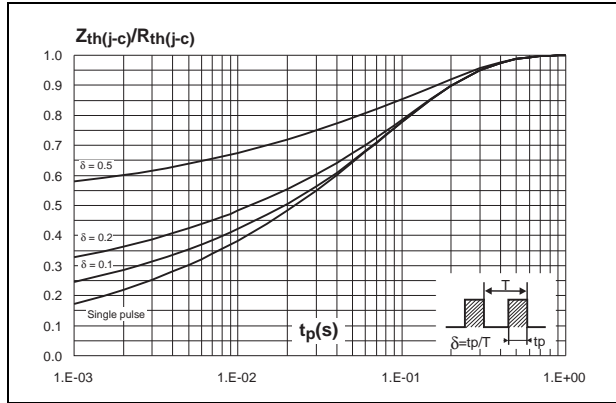

**Figure 4. Relative variation of thermal impedance junction to case versus pulse duration (TO-220FPAC)**

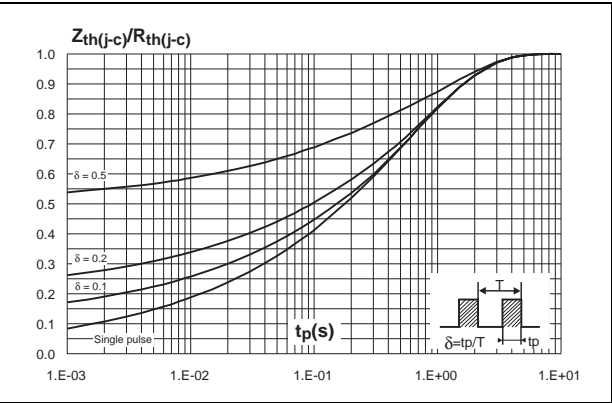

Figure 5. Relative variation of thermal impedance junction to ambient versus pulse duration (DO-201AD)

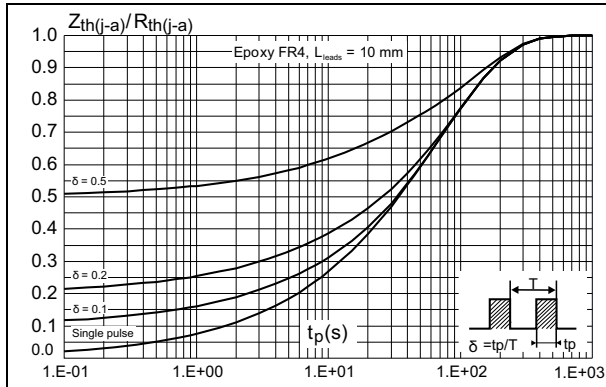

Figure 6. Peak reverse recovery current versus  $di_F/dt$  (typical values)

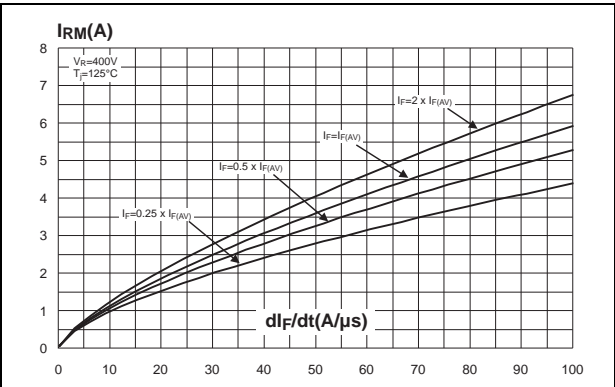

Figure 7. Reverse recovery time versus  $di_F/dt$  (typical values)

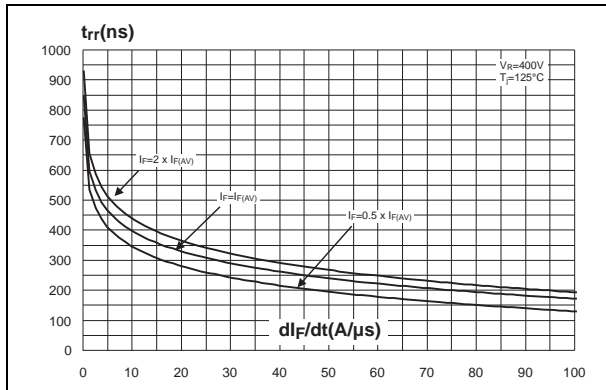

Figure 8. Reverse recovery charges versus  $di_F/dt$  (typical values)

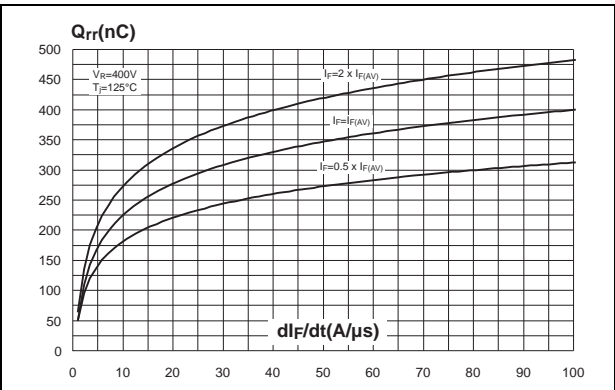

Figure 9. Softness factor versus  $di_F/dt$  (typical values)

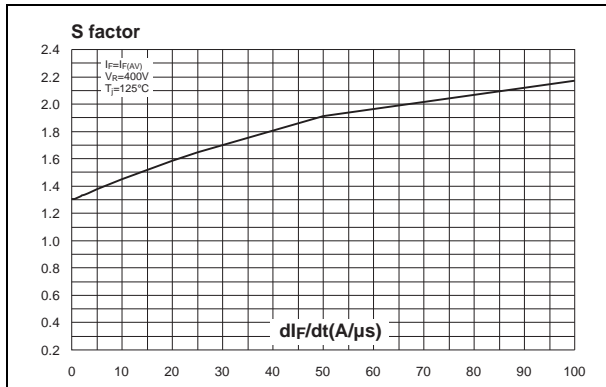

Figure 10. Relative variations of dynamic parameters versus junction temperature

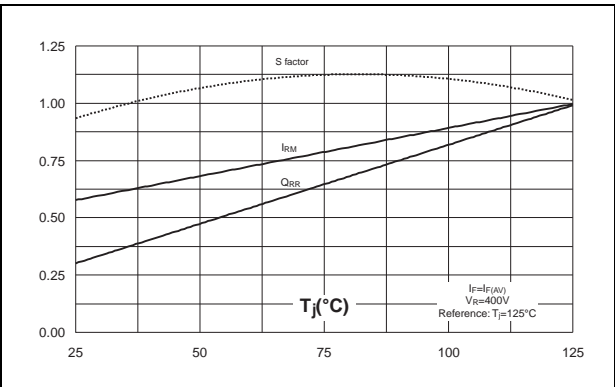

Figure 11. Transient peak forward voltage versus  $di_F/dt$  (typical values)

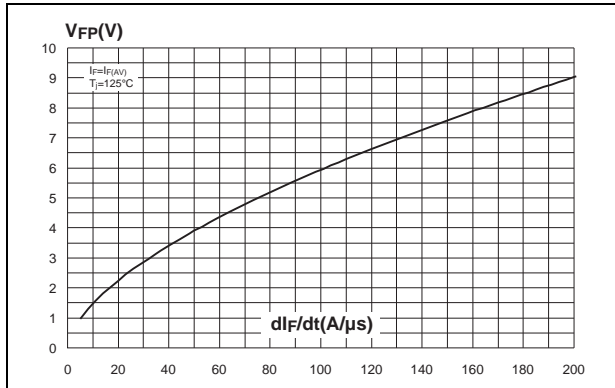

Figure 12. Forward recovery time versus  $di_F/dt$  (typical values)

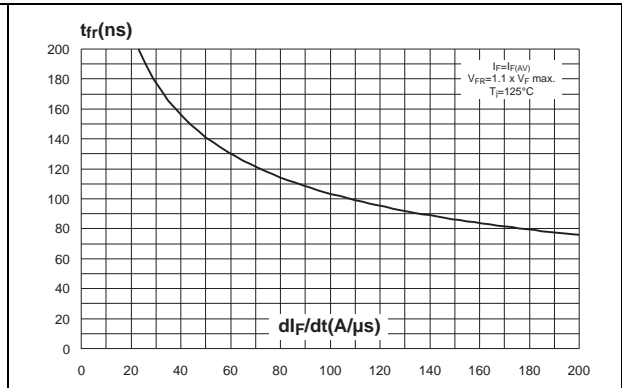

Figure 13. Junction capacitance versus reverse voltage applied (typical values)

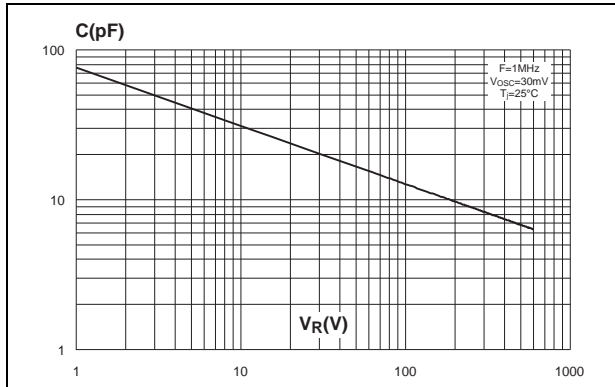

Figure 14. Thermal resistance junction to ambient versus copper surface under tab

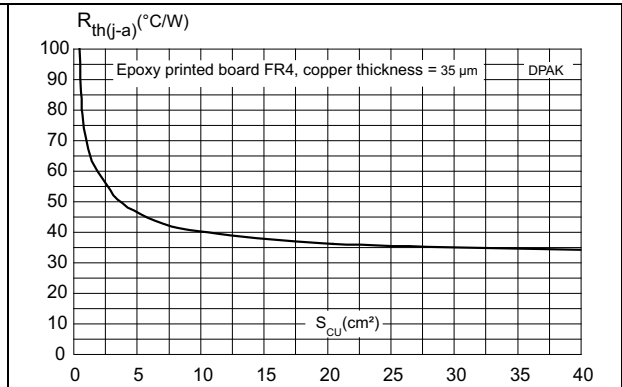
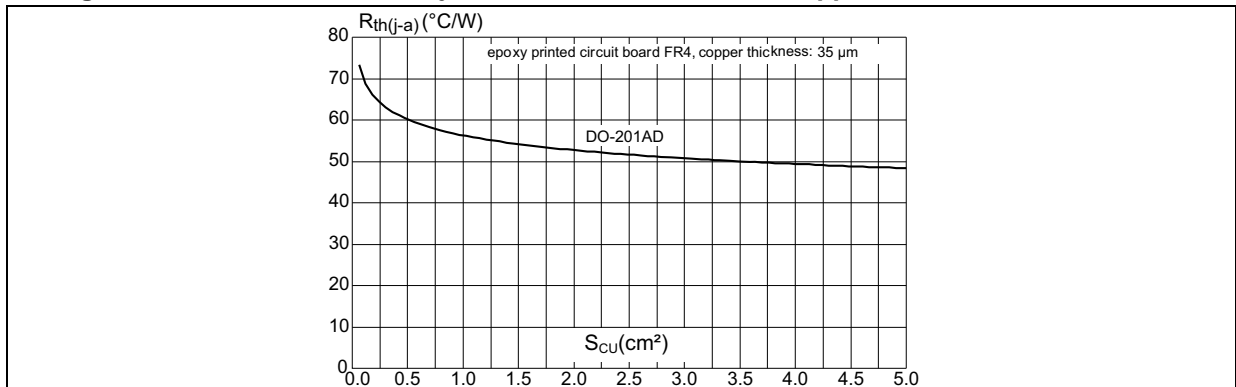

Figure 15. Thermal resistance junction to ambient versus copper surface under each lead



## 2 Package information

- Epoxy meets UL94, V0
- Cooling method: by conduction (C)
- Recommended torque value: 0.55 N·m (TO-220FPAC / TO-220AC)
- Maximum torque value: 0.7 N·m (TO-220FPAC / TO-220AC)

In order to meet environmental requirements, ST offers these devices in different grades of ECOPACK® packages, depending on their level of environmental compliance. ECOPACK® specifications, grade definitions and product status are available at: [www.st.com](http://www.st.com). ECOPACK® is an ST trademark.

Figure 16. TO-220AC dimension definitions

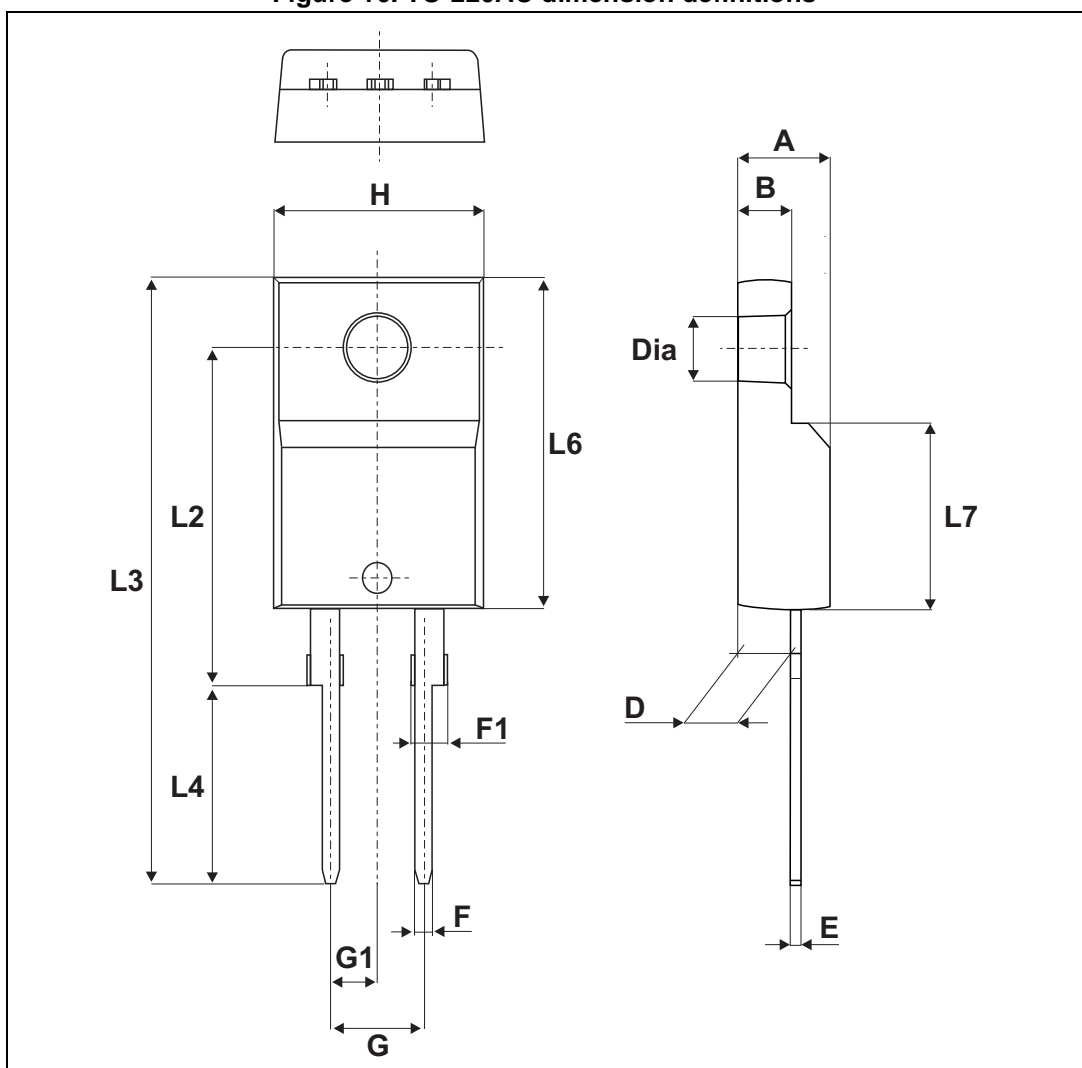

Table 6. TO-220AC dimension values

Ref.	Dimensions			
	Millimeters		Inches	
	Min.	Max.	Min.	Max.
A	4.40	4.60	0.173	0.181
C	1.23	1.32	0.048	0.051
D	2.40	2.72	0.094	0.107
E	0.49	0.70	0.019	0.027
F	0.61	0.88	0.024	0.034
F1	1.14	1.70	0.044	0.066
G	4.95	5.15	0.194	0.202
H2	10.00	10.40	0.393	0.409
L2	16.40 typ.		0.645 typ.	
L4	13.00	14.00	0.511	0.551
L5	2.65	2.95	0.104	0.116
L6	15.25	15.75	0.600	0.620
L7	6.20	6.60	0.244	0.259
L9	3.50	3.93	0.137	0.154
M	2.6 typ.		0.102 typ.	
Diam. I	3.75	3.85	0.147	0.151

Figure 17. TO-220FPAC dimension definitions

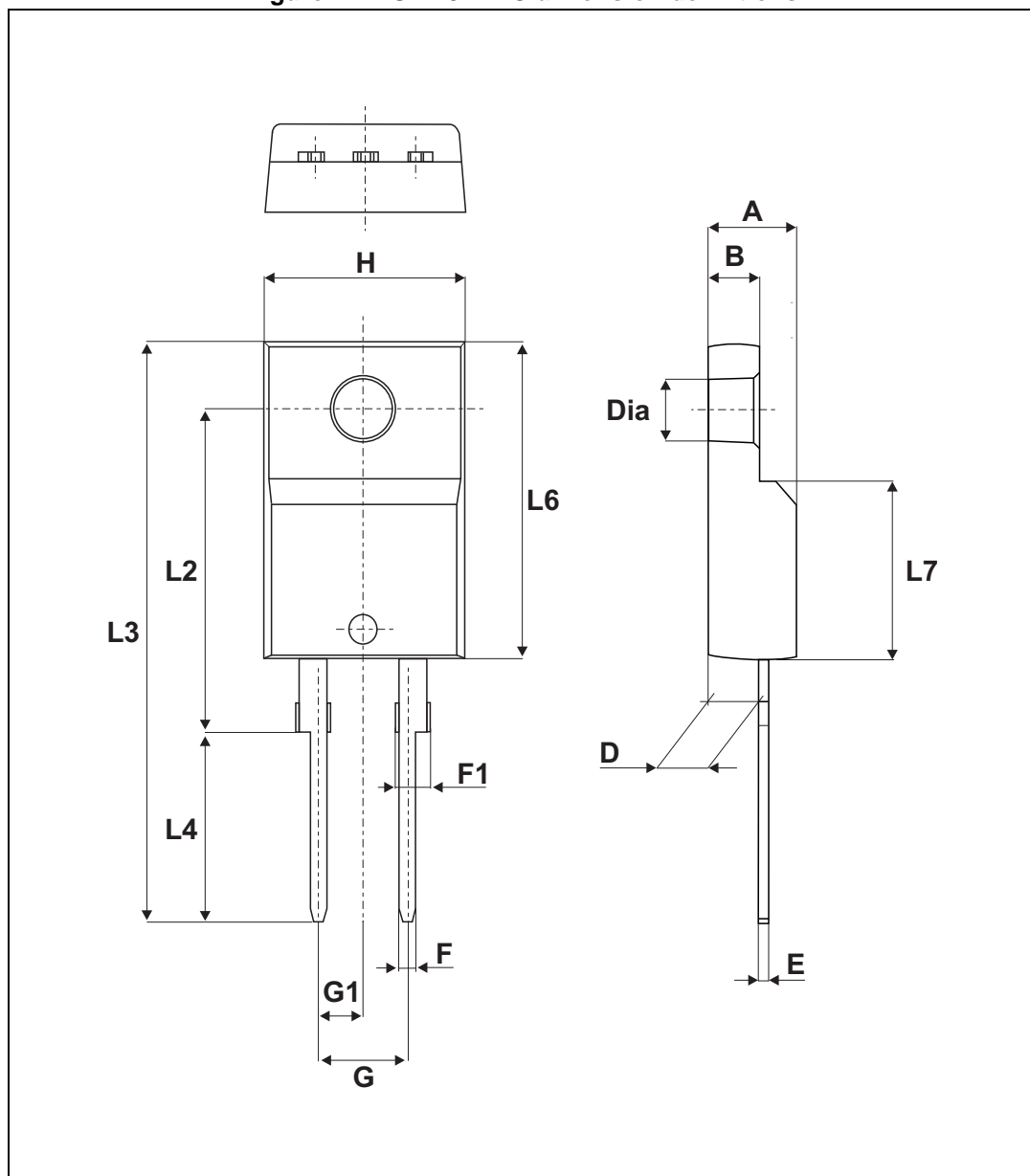



Table 7. TO-220FPAC dimension values

Ref.	Dimensions			
	Millimeters		Inches	
	Min.	Max.	Min.	Max.
A	4.4	4.6	0.173	0.181
B	2.5	2.7	0.098	0.106
D	2.5	2.75	0.098	0.108
E	0.45	0.70	0.018	0.027
F	0.75	1	0.030	0.039
F1	1.15	1.70	0.045	0.067
G	4.95	5.20	0.195	0.205
G1	2.4	2.7	0.094	0.106
H	10	10.4	0.393	0.409
L2	16 Typ.		0.63 Typ.	
L3	28.6	30.6	1.126	1.205
L4	9.8	10.6	0.386	0.417
L6	15.9	16.4	0.626	0.646
L7	9.00	9.30	0.354	0.366
Diam.	3.00	3.20	0.118	0.126

Figure 18. DO-201AD dimensions (definitions)

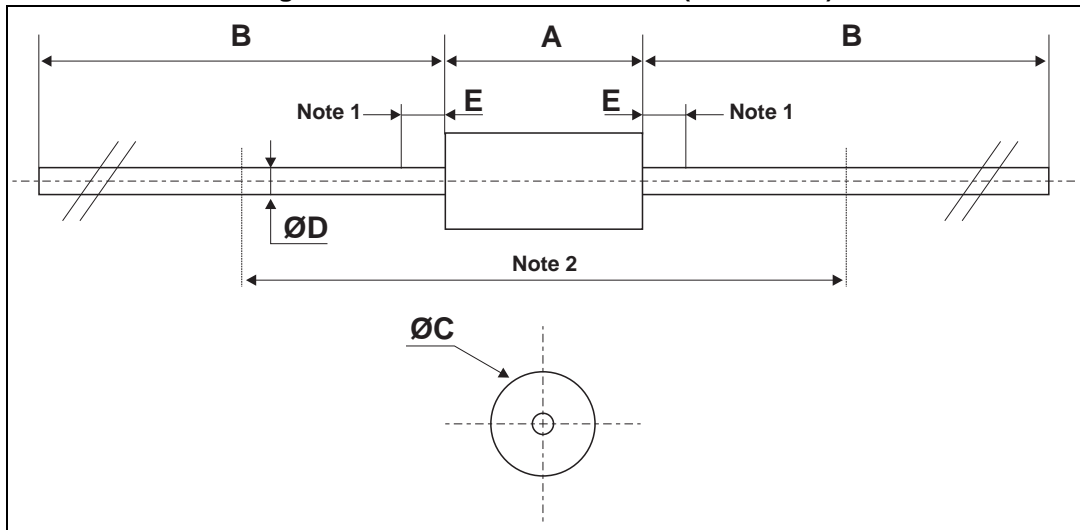
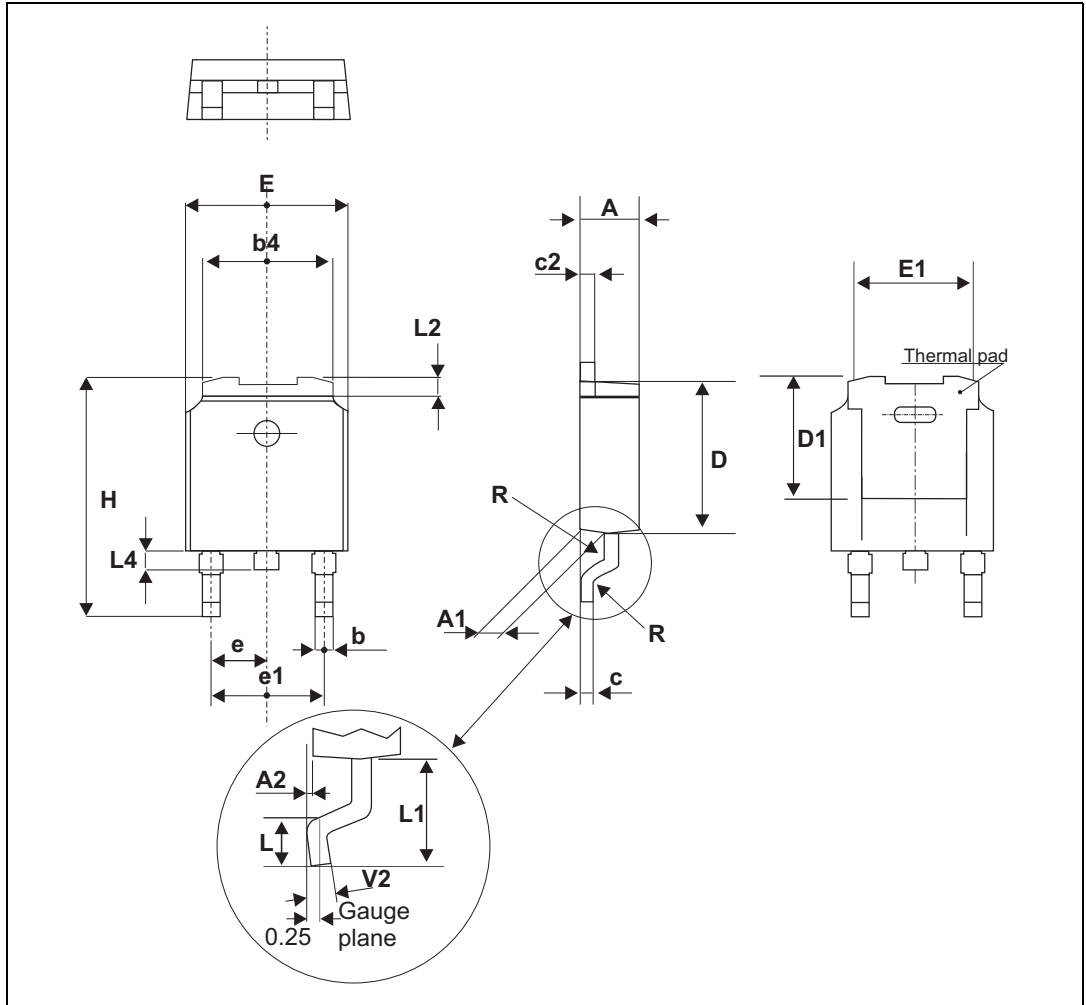

Table 8. DO-201AD dimensions (values)

Ref.	Dimensions			
	Millimeters		Inches	
	Min.	Max.	Min.	Max.
A		9.50		0.374
B	25.40		1.000	
C		5.30		0.209
D <sup>(1)</sup>		1.30		0.051
E		1.25		0.049
Note 2 <sup>(2)</sup>	15		0.59	

1. The lead diameter D is not controlled over zone E
2. The minimum length, which must stay straight between the right angles after bending, is 15 mm (0.59")

Figure 19. DPAK dimension definitions



Note: This package drawing may slightly differ from the physical package. However, all the specified dimensions are guaranteed.

Table 9. DPAK dimension values

Ref.	Dimensions					
	Millimeters			Inches		
	Min.	Typ.	Max.	Min.	Typ.	Max.
A	2.18		2.40	0.085		0.094
A1	0.90		1.1	0.035		0.043
A2	0.03		0.23	0.001		0.01
b	0.64		0.90	0.025		0.035
b4	4.95		5.46	0.195		0.215
c	0.46		0.61	0.018		0.024
c2	0.46		0.60	0.018		0.024
D	5.97		6.22	0.235		0.245
D1	5.10			0.201		
E	6.35		6.73	0.250		0.265
E1	4.32			0.170		
e1	4.4		4.7	0.173		0.185
H	9.35		10.40	0.368		0.407
L	1.0		1.78	0.039		0.070
L2			1.27			0.05
L4	0.6		1.02	0.024		0.040
V2	0°		8°	0°		8°

Figure 20. Footprint (dimensions in mm)

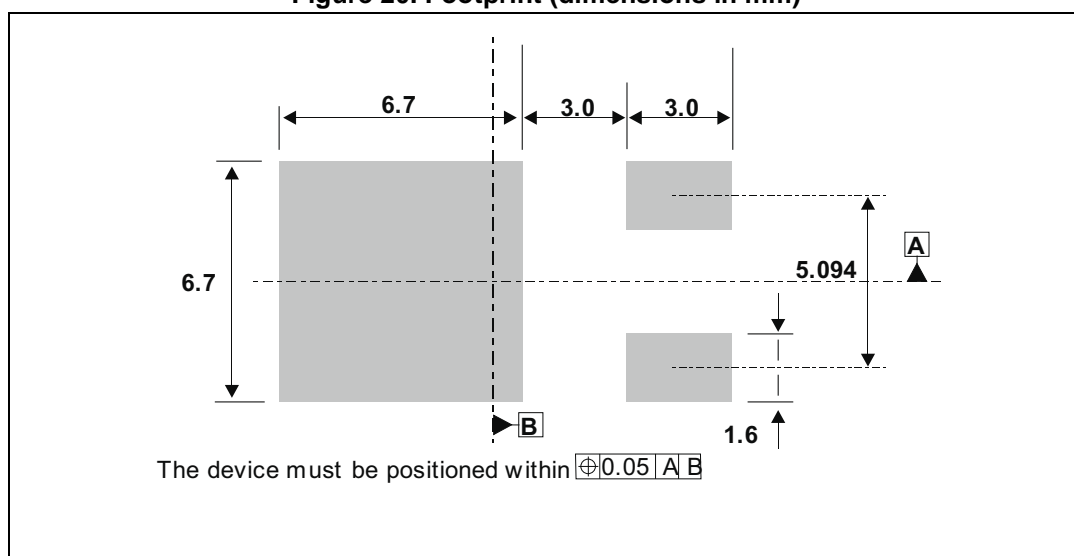

### 3 Ordering information

**Table 10. Ordering information**

Order code	Marking	Package	Weight	Base qty	Delivery mode
STTH5L06	STTH5L06	DO-201AD	1.16 g	600	Ammopack
STTH5L06RL	STTH5L06			1900	Tape and reel
STTH5L06D	STTH5L06D	TO-220AC	1.9 g	50	Tube
STTH5L06B-TR	STTH5L06B	DPAK	0.32 g	2500	Tape and reel
STTH5L06FP	STTH5L06FP	TO-220FPAC	1.9 g	50	Tube

### 4 Revision history

**Table 11. Document revision history**

Date	Revision	Changes
16-Nov-2001	1	Last release.
31-Mar-2007	2	Merged with TO-220AC, TO-220FPAC and DPAK version.
26-Nov-2014	3	Updated DPAK and reformatted to current standard.

**IMPORTANT NOTICE – PLEASE READ CAREFULLY**

STMicroelectronics NV and its subsidiaries ("ST") reserve the right to make changes, corrections, enhancements, modifications, and improvements to ST products and/or to this document at any time without notice. Purchasers should obtain the latest relevant information on ST products before placing orders. ST products are sold pursuant to ST's terms and conditions of sale in place at the time of order acknowledgement.

Purchasers are solely responsible for the choice, selection, and use of ST products and ST assumes no liability for application assistance or the design of Purchasers' products.

No license, express or implied, to any intellectual property right is granted by ST herein.

Resale of ST products with provisions different from the information set forth herein shall void any warranty granted by ST for such product.

ST and the ST logo are trademarks of ST. All other product or service names are the property of their respective owners.

Information in this document supersedes and replaces information previously supplied in any prior versions of this document.

© 2014 STMicroelectronics – All rights reserved