

## Basic Characteristics Data

Model	Circuit method	Switching frequency [kHz]	Input current [A] *1	Inrush current protection circuit	PCB/Pattern			Series/Parallel operation availability	
					Material	Single sided	Double sided	Series operation	Parallel operation
TUNS50F	Active filter	80-600	0.67	Thermistor	Aluminum	Yes		Yes	*2
	Flyback converter	100-300							
TUNS100F	Active filter	80-600	1.3	Thermistor	Aluminum	Yes		Yes	*2
	Forward converter	300							
TUNS300F	Active filter	100	3.6	SCR	Aluminum	Yes		Yes	*2
	Half-bridge converter	400							
TUNS500F	Active filter	100	6.0	SCR	Aluminum	Yes		Yes	*2
	Half-bridge converter	400							

\*1 The value of input current is at ACIN 100V and rated load.

\*2 Refer to instruction manual.

## TUNS50F, TUNS100F

**1** Pin Connection TUNS-12

**2** Connection for Standard Use TUNS-12

**3** Wiring Input/Output Pin TUNS-13

- 3.1 Wiring input pin ..... TUNS-13
- 3.2 Wiring output pin ..... TUNS-13
- 3.3 Wiring +BC/-BC pins ..... TUNS-13

**4** Function TUNS-14

- 4.1 Input voltage range ..... TUNS-14
- 4.2 Overcurrent protection ..... TUNS-14
- 4.3 Overvoltage protection ..... TUNS-14
- 4.4 Thermal protection ..... TUNS-14
- 4.5 Remote sensing ..... TUNS-14
- 4.6 Adjustable voltage range ..... TUNS-15
- 4.7 Withstanding Voltage/Isolation Voltage .. TUNS-15

**5** Series and Parallel Operation TUNS-15

- 5.1 Series operation ..... TUNS-15
- 5.2 Parallel operation ..... TUNS-15

**6** Implementation · Mounting Method TUNS-16

- 6.1 Mounting method ..... TUNS-16
- 6.2 Stress to the pins ..... TUNS-16
- 6.3 Cleaning ..... TUNS-16
- 6.4 Soldering temperature ..... TUNS-16
- 6.5 Derating ..... TUNS-16
- 6.6 Heat sink (Optional parts) ..... TUNS-17

**7** Lifetime expectancy depends on stress by temperature difference TUNS-18

## TUNS300F, TUNS500F

**1** Pin Connection TUNS-19

**2** Connection for Standard Use TUNS-19

**3** Wiring Input/Output Pin TUNS-20

- 3.1 Wiring input pin ..... TUNS-20
- 3.2 Wiring output pin ..... TUNS-20
- 3.3 Wiring +BC/-BC pins ..... TUNS-20

**4** Function TUNS-21

- 4.1 Input voltage range ..... TUNS-21
- 4.2 Overcurrent protection ..... TUNS-21
- 4.3 Peak current protection ..... TUNS-21
- 4.4 Overvoltage protection ..... TUNS-21
- 4.5 Thermal protection ..... TUNS-21
- 4.6 Remote sensing ..... TUNS-21
- 4.7 Adjustable voltage range ..... TUNS-22
- 4.8 Inverter operation monitor (IOG) ..... TUNS-22
- 4.9 Withstanding Voltage/Isolation Voltage .. TUNS-22

**5** Series and Parallel Operation TUNS-22

- 5.1 Series operation ..... TUNS-22
- 5.2 Parallel operation ..... TUNS-22

**6** Implementation · Mounting Method TUNS-23

- 6.1 Mounting method ..... TUNS-23
- 6.2 Stress to the pins ..... TUNS-23
- 6.3 Cleaning ..... TUNS-23
- 6.4 Soldering temperature ..... TUNS-23
- 6.5 Derating ..... TUNS-23

**7** Peak current TUNS-24

**8** Lifetime expectancy depends on stress by temperature difference TUNS-24

## 1 Pin Connection

### ●TUNS50F

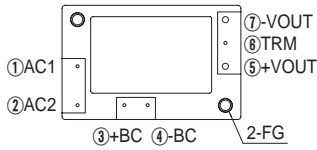

### ●TUNS100F

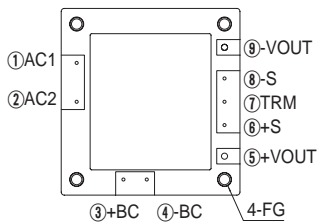

Fig.1.1 Pin connection (bottom view)

Table 1.1 Pin connection and function

No.		Pin Connection	Function
TUNS50F	TUNS100F		
①	①	AC1	AC input
②	②	AC2	
③	③	+BC	+BC output
④	④	-BC	-BC output
⑤	⑤	+VOUT	+DC output
⑦	⑨	-VOUT	-DC output
-	⑧	-S	Remote sensing (-)
-	⑥	+S	Remote sensing (+)
⑥	⑦	TRM	Adjustment of output voltage
-	-	FG	Mounting hole (FG)

## 2 Connection for Standard Use

■To use TUNS series, connection shown in Fig.2.1 and external components are required.

■This product uses conduction cooling method (e.g. heat radiation from the aluminum base plate to the attached heat sink).  
Reference: 6.5 "Derating"

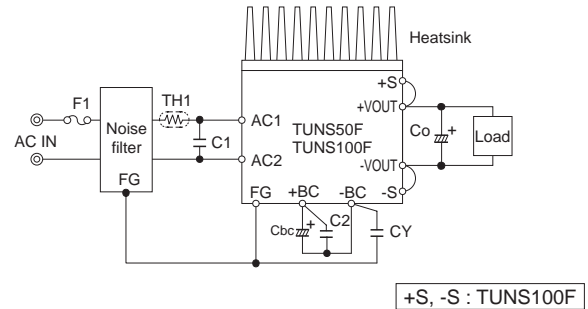

Fig.2.1 Connection for standard use

Table 2.1 External components

No.	Symbol	Components	Reference
1	F1	Input fuse	3.1 "Wiring input pin (1)"
2	C1	Input Capacitor	3.1 "Wiring input pin (2)"
3	-	Noise Filter	3.1 "Wiring input pin (3)"
4	CY	Y capacitor	3.1 "Wiring input pin (3)"
5	TH1	Inrush current protection thermistor	3.1 "Wiring input pin (4)"
6	Co	Output capacitor	3.2 "Wiring output pin (1)"
7	Cbc	Smoothing Capacitor for boost voltage	3.3 "Wiring +BC/-BC pins (1)"
8	C2	Capacitor for boost voltage	3.3 "Wiring +BC/-BC pins (2)"
9	-	Heatsink	6.6 "Heat sink"

## 3 Wiring Input/Output Pin

### 3.1 Wiring input pin

#### (1) F1 : External fuse

■ Fuse is not built-in on input side. In order to protect the unit, install the slow-blow type fuse on input side (as shown in Table 3.1).

Table 3.1 Recommended fuse (Slow-blow type)

Model	TUNS50F	TUNS100F
Rated current	2A	3.15A

#### (2) C1 : External Capacitor for input side

■ Install a film capacitor as input capacitor C1 of which the capacitance and ripple current capability are above the values shown in Table 3.2.

■ Use a safety approved capacitor with 250V ac rated voltage.

■ If C1 is not connected, it may cause the failure of the power supply or external components.

Table 3.2 Input Capacitor C1

No.	Model	Voltage	Capacitance	Rated ripple current
1	TUNS50F	AC250V	1 $\mu$ F or more	3A or more
2	TUNS100F		1 $\mu$ F or more	3A or more

#### (3) CY : Noise filter/Decoupling capacitor

■ The product doesn't have noise filter internally.

Please connect external noise filter and primary decoupling capacitor CY for low line noise and stable operation of the power supply.

■ The operation of the power supply may be unstable due to the resonance of the filter or inductance.

■ Install a correspondence filter, if it is required to meet a noise standard or if the surge voltage may be applied to the unit.

■ Install a primary decoupling capacitor CY, with more than 470pF, near the input pins (within 50mm from the pins).

■ When the total capacitance of the primary decoupling capacitor is more than 8800pF, the nominal value in the specification may not be met by the Hi-Pot test between input and output. A capacitor should be installed between output and FG.

#### (4) TH1 : Inrush current limiting thermistor

■ It has a possibility that internal components fail by inrush current, so please use power thermistor or inrush current limiting circuit to keep input current below 60A.

■ If you use power thermistor and turn the power ON/OFF repeatedly within a short period of time, please have enough intervals so that a power supply cools down before being turned on. And appropriate intervals should be set even if inrush current limiting circuit except power thermistor is used.

■ The output voltage may become unstable at low temperature due to the ESR of power thermistor. In this case, increase the capacitance of Cbc more than recommended value or connect same capacitors in parallel. Please evaluate before use.

### 3.2 Wiring output pin

#### (1) Co : Output capacitor

■ Install an external capacitor Co between +VOUT and -VOUT pins for stable operation of the power supply (Fig.2.1).

Recommended capacitance of Co is shown in Table 3.3.

■ Select the high frequency type capacitor. Output ripple and start-up waveform may be influenced by ESR-ESL of the capacitor and the wiring impedance.

■ Install a capacitor Co near the output pins (within 50mm from the pins).

■ When the power supply is used under 0°C ambient temperature, output ripple voltage increases. In this case, connect 3 capacitors Co in parallel connection.

Table 3.3 Recommended capacitance Co[ $\mu$ F]

Model	Temperature of base plate			
	Tc=0 to +100°C		Tc=-40 to +100°C	
Output voltage (V)	TUNS50F	TUNS100F	TUNS50F	TUNS100F
5	2200	2200	2200x3	2200x3
12	470	470	470x3	470x3
24	220	220	220x3	220x3

The specified ripple and ripple noise are measured by the method introduced in Fig.3.1.

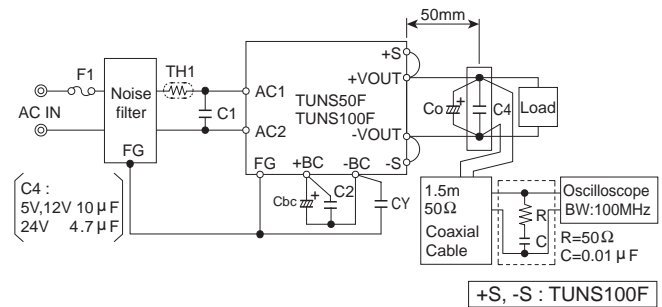

Fig.3.1 Method of Measuring Output Ripple and Ripple Noise

### 3.3 Wiring +BC/-BC pins

#### (1) Cbc : Smoothing capacitor for boost voltage

■ In order to smooth boost voltage, connect Cbc between +BC and -BC. Recommended capacitance of Cbc is shown in Table 3.4.

■ Note that +BC and -BC terminals have high voltage (DC385V typ).

■ Keep the capacitance within the allowable external capacitance.

■ Select a capacitor of which the boost voltage ripple voltage does not exceed 30Vp-p.

■ When the power supply is operated under -20°C, it may make the boost voltage unstable due to the characteristic of equivalent series resistor. Please choose the capacitor which has more than recommended capacitance.

Table 3.4 Recommended capacitance Cbc

No.	Model	Voltage	Cbc	Allowable capacitance range
1	TUNS50F	DC420V	82 $\mu$ F	47 to 150 $\mu$ F
2	TUNS100F	or more	120 $\mu$ F	68 to 220 $\mu$ F

(2) C2 : Capacitor for boost voltage

- Install external capacitors C2 with capacitance shown in table 3.5.
- If capacitors C2 are not installed, it may cause the failure of the power supply or external components.

Table 3.5 Recommended capacitance C2

No.	Model	Voltage	Capacitance	Rated ripple current
1	TUNS50F	DC450V	0.47 $\mu$ F or more	1A or more
2	TUNS100F		0.47 $\mu$ F or more	1A or more

## 4 Function

### 4.1 Input voltage range

- The input voltage range is from 85 VAC to 264 VAC.
- In cases that conform with safety standard, input voltage range is AC100-AC240V(50/60Hz).
- Be aware that use of voltages other than those listed above may result in the unit not operating according to specifications, or may cause damage. Avoid square waveform input voltage, commonly used in UPS units and inverters.

### 4.2 Overcurrent protection

- Overcurrent protection is built-in and comes into effect at over 105% of the rated current. Overcurrent protection prevents the unit from short circuit and overcurrent condition. The unit automatically recovers when the fault condition is cleared.
- When the output voltage drops at overcurrent, the average output current is reduced by intermittent operation of power supply.

### 4.3 Overvoltage protection

- Overvoltage protection circuit is built-in. If the overvoltage protection circuit is activated, shut down the input voltage, wait more than 3 minutes and turn on the AC input again to recover the output voltage. Recovery time varies depending on such factors as input voltage value at the time of the operation.

#### Remarks:

Please note that devices inside the power supply might fail when voltage of more than rated output voltage is applied to output terminal of the power supply. This could happen when the customer tests the overvoltage performance of the unit. To check the function of overvoltage protection, adjust the output voltage by changing TRM voltage. Please contact us for details.

### 4.4 Thermal protection

- When the power supply temperature is kept above 100°C, the thermal protection will be activated and simultaneously shut down the output.

When the thermal protection is activated, shut off the input voltage and eliminate all the overheating conditions. To recover the output voltage, keep enough time to cool down the power supply before turning on the input voltage again.

### 4.5 Remote sensing

#### ● TUNS50F

- Remote sensing is not built-in.

#### ● TUNS100F

- Remote sensing is built-in.

(1) When the remote sensing function is not in use

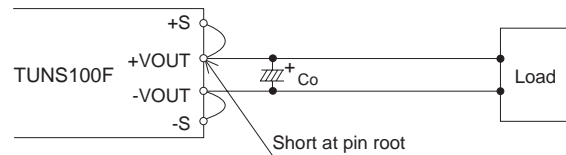

Fig. 4.1 Connection when the remote sensing is not in use

- When the remote sensing function is not in use, it is necessary to confirm that pins are shorted between +S & +VOUT and between -S & -VOUT.

- Wire between +S & +VOUT and between -S & -VOUT as short as possible.

Loop wiring should be avoided.

This power supply might become unstable by the noise coming from poor wiring.

(2) When the remote sensing function is in use

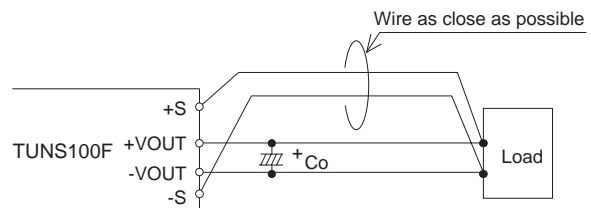

Fig. 4.2 Connection when the remote sensing is in use

- Twisted-pair wire or shield wire should be used for sensing wire.

- Thick wire should be used for wiring between the power supply and a load.

Line drop should be less than 0.5V.

Voltage between +VOUT and -VOUT should remain within the output voltage adjustment range.

- If the sensing patterns are short, heavy-current is drawn and the pattern may be damaged.

The pattern disconnection can be prevented by installing the protection parts as close as a load.

■As wiring or load impedance may generate oscillation or large fluctuations in output voltage, make sure enough evaluation is given advance.

### 4.6 Adjustable voltage range

■Output voltage between +VOUT and -VOUT can be adjusted by connecting external resistors to TRM.

■When the output voltage adjustment is not used, open the TRM pin respectively.

■When the output voltage adjustment is used, note that the over-voltage protection circuit operates when output voltage is set too high.

■The wiring to the potentiometer should be as short as possible.

As the ambient temperature fluctuation characteristics deteriorate depending on the types of resistors and potentiometers, please use resistors and potentiometers of the following specifications:

Resistors..... Metal film type, coefficient less than  $\pm 100\text{ppm}/^\circ\text{C}$

Potentiometers ... Cermet type, coefficient less than  $\pm 300\text{ppm}/^\circ\text{C}$

■Output voltage can be adjusted by connecting an external potentiometer (VR1) and resistors (R1 and R2) as shown in Fig. 4.3.

Output voltage will increase if the resistance between ② and ③ is reduced by turning the potentiometer.

Recommended values for external components are shown in Table 4.1.

Consult us if the power module is used in a different configuration.

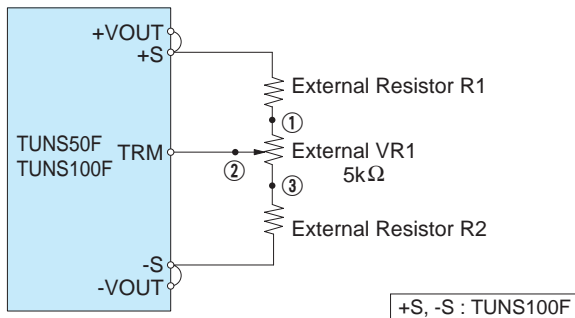

Fig. 4.3 Connecting External Devices (TUNS50F/TUNS100F)

Table 4.1 Recommended Values of External Resistors (TUNS50F, TUNS100F)

No.	Output Voltage	Adjustable Range			
		$V_{OUT} \pm 5\%$		$V_{OUT} \pm 10\%$	
		R1	R2	R1	R2
1	5V	10kΩ	2.7kΩ	4.7kΩ	1kΩ
2	12V	12kΩ	2.2kΩ	5.6kΩ	560Ω
3	24V	27kΩ	1.8kΩ	15kΩ	470Ω

### 4.7 Withstanding Voltage / Isolation Voltage

■When testing the withstanding voltage, make sure the voltage is increased gradually. When turning off, reduce the voltage gradually by using the dial of the hi-pot tester. Do not use a voltage tester with a timer as it may generate voltage several times as large as the applied voltage.

## 5 Series and Parallel Operation

### 5.1 Series operation

■Series operation is available by connecting the outputs of two or more power supplies as shown below. Output current in series connection should be lower than the lowest rated current in each unit.

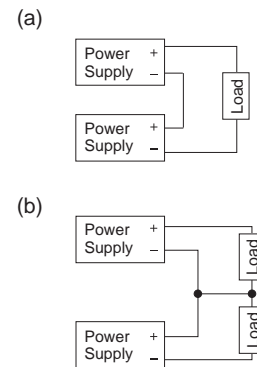

Fig. 5.1 Examples of series operation

### 5.2 Parallel operation

■Parallel operation is not possible.

■Redundancy operation is available by wiring as shown below.

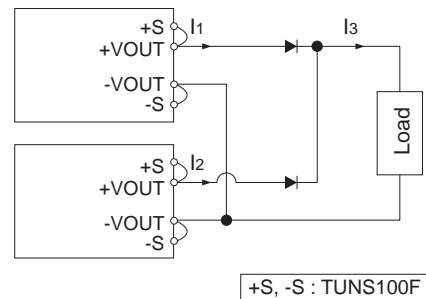

Fig. 5.2 Example of Redundancy Operation

■Even a slight difference in output voltage can affect the balance between the values of  $I_1$  and  $I_2$ .

Please make sure that the value of  $I_3$  does not exceed the rated current of a power supply.

$$I_3 \leq \text{the rated current value}$$

## 6 Implementation · Mounting Method

### 6.1 Mounting method

- The unit can be mounted in any direction. When two or more power supplies are used side by side, position them with proper intervals to allow enough air ventilation. Aluminum base plate temperature of each power supply should not exceed the temperature range shown in derating curve.
- Avoid placing the AC input line pattern layout underneath the unit. It will increase the line conducted noise. Make sure to leave an ample distance between the line pattern layout and the unit. Also avoid placing the DC output line pattern underneath the unit because it may increase the output noise. Lay out the pattern away from the unit.
- Avoid placing the signal line pattern layout underneath the unit because the power supply might become unstable. Lay out the pattern away from the unit.
- High-frequency noise radiates directly from the unit to the atmosphere. Therefore, design the shield pattern on the printed circuit board and connect it to FG. The shield pattern prevents noise radiation.

### 6.2 Stress to the pins

- When too much stress is applied to the pins may damage internal connections. Avoid applying stress in excess of that shown in Fig. 6.1.
- The pins are soldered onto the internal PCB. Therefore, Do not bend or pull the leads with excessive force.
- Mounting hole diameter of PCB should be 3.5mm to reduce the stress to the pins.
- Fix the unit on PCB (fixing fittings) by screws to reduce the stress to the pins. Be sure to mount the unit first, then solder the unit.

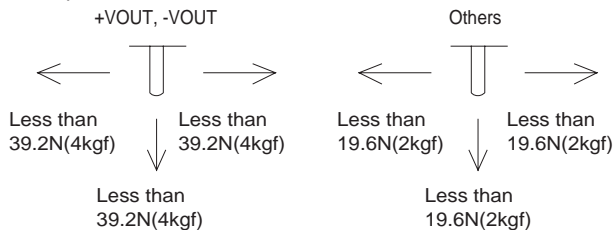

Fig. 6.1 Stress to the pins

### 6.3 Cleaning

- Clean the product with a brush. Prevent liquid from getting into the product. Do not soak the product into liquid.
- Do not stick solvent to a name plate or a resin case. (If solvent sticks to a name plate or a resin case, it will cause to change the color of the case or to fade letters on name plate away.)
- After cleaning, dry them enough.

### 6.4 Soldering temperature

- Flow soldering: 260°C for up to 15 seconds.
- Soldering iron (26W): 450°C for up to 5 seconds.

### 6.5 Derating

#### (1) Input voltage derating curve

Input voltage derating curve is shown in Fig.6.2.

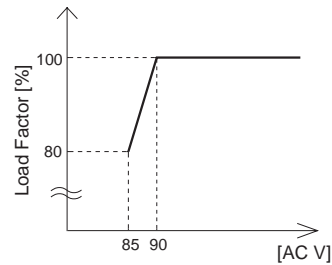

Fig. 6.2 Input voltage derating curve

#### (2) Output voltage derating curve

- Use the power modules with conduction cooling (e.g. heat dissipation from the aluminum base plate to the attached heat sink). Fig. 6.3 shows the derating curves with respect to the aluminum base plate temperature. Note that operation within the hatched areas will cause a significant level of ripple and ripple noise.
- Please measure the temperature on the aluminum base plate edge side when you cannot measure the temperature of the center part of the aluminum base plate. In this case, please take 5deg temperature margin from the derating characteristics shown in Fig.6.3. Please reduce the temperature fluctuation range as much as possible when the up and down of the temperature are frequently generated. Contact us for more information on cooling methods.

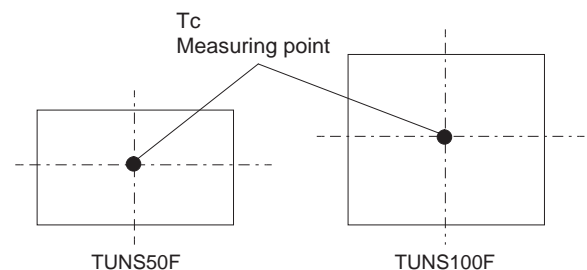
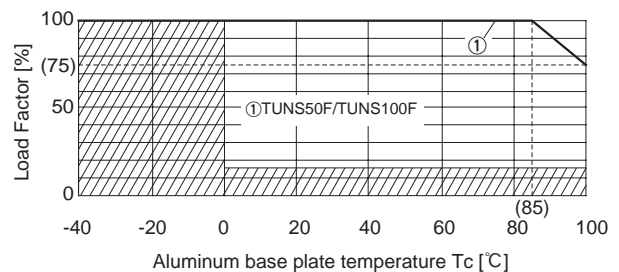

Fig.6.3 Derating curve



### 6.6 Heat sink (Optional parts)

The power module works with conduction cooling and needs heat dissipation using heat sinks. Optional heat sinks are available for TUNS50F/TUNS100F Series. Refer to Table 6.1 and Table 6.2 for details on the thermal resistance of heat sinks.

#### TUNS50F

Table 6.1 Types of Heat Sinks Available

No.	Model	Size[mm]			Thermal resistance[°C/W]		Style
		H	W	D	Convection (0.1m/s)	Forced Air	
1	F-QB-F1	12.7	58.4	37.6	14.0	Refer Fig.6.5	Horizontal
2	F-QB-F2	12.7	58.7	37.3			Vertical
3	F-QB-F3	25.4	58.4	37.6	7.5		Horizontal
4	F-QB-F4	25.4	58.7	37.3			Vertical
5	F-QB-F5	38.1	58.4	37.6	5.0		Horizontal
6	F-QB-F6	38.1	58.7	37.3			Vertical

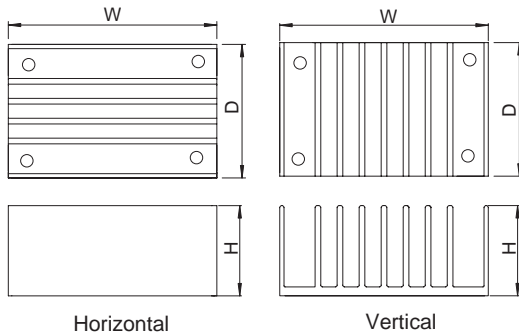

Fig.6.4 Heat Sink Types

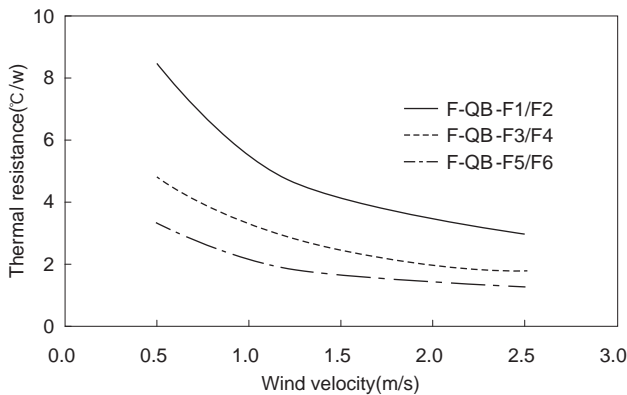

Fig.6.5 Thermal Resistance of Heat Sink(Forced Air)

#### TUNS100F

Table 6.2 Types of Heat Sinks Available

No.	Model	Size[mm]			Thermal resistance[°C/W]		Style
		H	W	D	Convection (0.1m/s)	Forced Air	
1	F-CBS-F1	12.7	57.9	61.5	7.5	Refer Fig.6.7	Horizontal
2	F-CBS-F2	12.7	58.4	61.0			Vertical
3	F-CBS-F3	25.4	57.9	61.5	4.6		Horizontal
4	F-CBS-F4	25.4	58.4	61.0			Vertical
5	F-CBS-F5	38.1	57.9	61.5	3.0		Horizontal
6	F-CBS-F6	38.1	58.4	61.0			Vertical

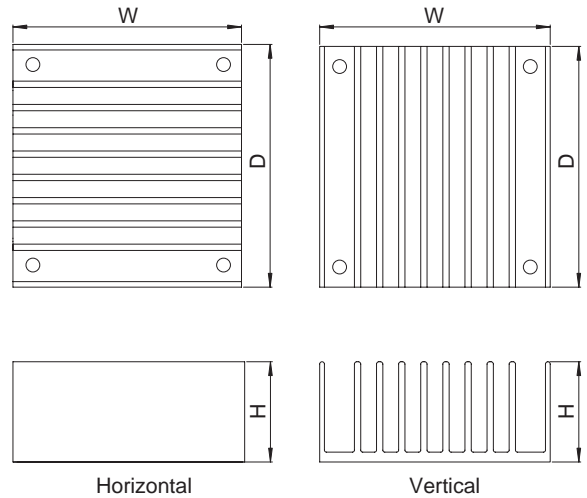

Fig.6.6 Heat Sink Types

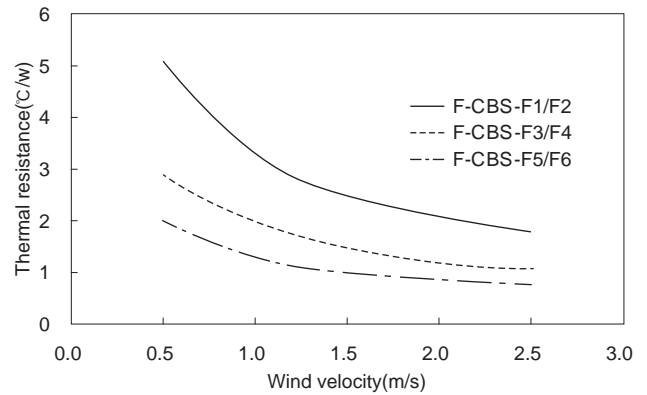

Fig.6.7 Thermal Resistance of Heat Sink(Forced Air)



## 7 Lifetime expectancy depends on stress by temperature difference

■ Regarding lifetime expectancy design of solder joint, following contents must be considered.

It must be careful that the soldering joint is stressed by temperature rise and down which is occurred by self-heating and ambient temperature change.

The stress is accelerated by thermal-cycling, therefore the temperature difference should be minimized as much as possible if temperature rise and down is occurred frequently.

■ Product lifetime expectancy depends on the aluminum base plate central temperature difference ( $\Delta T_c$ ) and number of cycling in a day is shown in Fig.7.1.

If the aluminum base plate center part temperature changes frequently by changing output load factor etc., the above the lifetime expectancy design should be applied as well.

Please contact us for details.

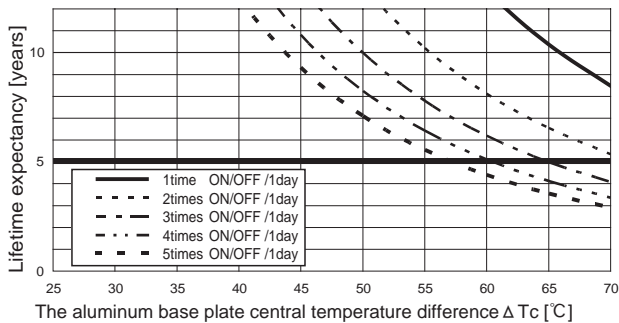

Fig.7.1 Lifetime expectancy against rise/fall temperature difference

Application manuals available at our website.

Recommended external components are also introduced for your reference.

# 1 Pin Connection

## ●TUNS300F/TUNS500F

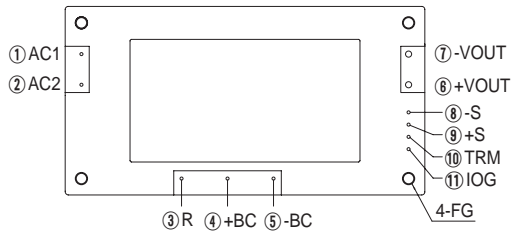

Fig.1.1 Pin connection (bottom view)

Table 1.1 Pin connection and function

No.	Pin Connection	Function
①	AC1	AC input
②	AC2	
③	R	External resistor for inrush current protection
④	+BC	+BC output
⑤	-BC	-BC output
⑥	+VOUT	+DC output
⑦	-VOUT	-DC output
⑧	-S	Remote sensing (-)
⑨	+S	Remote sensing (+)
⑩	TRM	Adjustment of output voltage
⑪	IOG	Inverter operation monitor
-	FG	Mounting hole (FG)

# 2 Connection for Standard Use

■To use TUNS series, connection shown in Fig.2.1 and external components are required.

■This product uses conduction cooling method (e.g. heat radiation from the aluminum base plate to the attached heat sink).  
Reference: 6.5 "Derating"

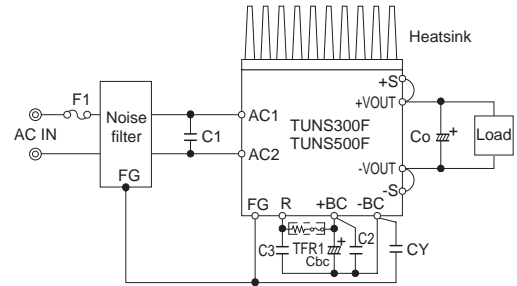

Fig.2.1 Connection for standard use

Table 2.1 External components

No.	Symbol	Components	Reference
1	F1	Input fuse	3.1 "Wiring input pin (1)"
2	C1	Input Capacitor	3.1 "Wiring input pin (2)"
3	-	Noise Filter	3.1 "Wiring input pin (3)"
4	CY	Y capacitor	3.1 "Wiring input pin (3)"
5	Co	Output capacitor	3.2 "Wiring output pin (1)"
6	Cbc	Smoothing Capacitor for boost voltage	3.3 "+BC/-BC pins (1)"
7	C2,C3	Capacitor for boost voltage	3.3 "+BC/-BC pins (2)"
8	TFR1	Inrush current protection resistor	3.3 "+BC/-BC pins (3)"
9	-	Heatsink	-

## 3 Wiring Input/Output Pin

### 3.1 Wiring input pin

#### (1) F1 : External fuse

■ Fuse is not built-in on input side. In order to protect the unit, install the slow-blow type fuse on input side (as shown in Table 3.1).

Table 3.1 Recommended fuse (Slow-blow type)

Model	TUNSS300F	TUNSS500F
Rated current	10A	15A

#### (2) C1 : External Capacitor for input side

■ Install a film capacitor as input capacitor C1 of which the capacitance and ripple current capability are above the values shown in Table 3.2.

■ Use a safety approved capacitor with 250V ac rated voltage.

■ If C1 is not connected, it may cause the failure of the power supply or external components.

Table 3.2 Input Capacitor C1

No.	Model	Voltage	Capacitance	Rated ripple current
1	TUNSS300F	AC250V	2 $\mu$ F or more	5A or more
2	TUNSS500F		2 $\mu$ F or more	5A or more

#### (3) CY : Noise filter/Decoupling capacitor

■ The product doesn't have noise filter internally.

Please connect external noise filter and primary decoupling capacitor CY for low line noise and stable operation of the power supply.

■ The operation of the power supply may be unstable due to the resonance of the filter or inductance.

■ Install a correspondence filter, if it is required to meet a noise standard or if the surge voltage may be applied to the unit.

■ Install a primary decoupling capacitor CY, with more than 470pF, near the input pins (within 50mm from the pins).

■ When the total capacitance of the primary decoupling capacitor is more than 8800pF, the nominal value in the specification may not be met by the Hi-Pot test between input and output. A capacitor should be installed between output and FG.

### 3.2 Wiring output pin

#### (1) Co : Output capacitor

■ Install an external capacitor Co between +VOUT and -VOUT pins for stable operation of the power supply (Fig.2.1).

Recommended capacitance of Co is shown in Table 3.3.

■ Select the high frequency type capacitor. Output ripple and start-up waveform may be influenced by ESR-ESL of the capacitor and the wiring impedance.

■ Install a capacitor Co near the output pins (within 50mm from the pins).

■ When the power supply is used under 0°C ambient temperature, output ripple voltage increases. In this case, connect 3 capacitors Co in parallel connection.

Table 3.3 Recommended capacitance Co[ $\mu$ F]

Model	Temperature of base plate	
	Tc=0 to +100°C	Tc=-40 to +100°C
Output voltage (V)	TUNSS300F/TUNSS500F	TUNSS300F/TUNSS500F
12	2200	2200x3
28	1000	1000x3
48	470	470x3

The specified ripple and ripple noise are measured by the method introduced in Fig.3.1.

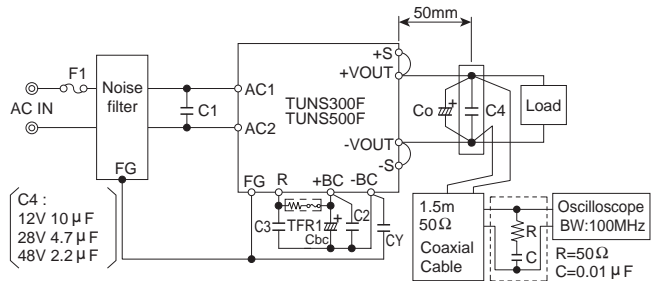

Fig.3.1 Method of Measuring Output Ripple and Ripple Noise

### 3.3 Wiring +BC/-BC pins

#### (1) Cbc : Smoothing capacitor for boost voltage

■ In order to smooth boost voltage, connect Cbc between +BC and -BC. Recommended capacitance of Cbc is shown in Table 3.4.

■ Note that +BC and -BC terminals have high voltage (DC380V typ).

■ Keep the capacitance within the allowable external capacitance.

■ Select a capacitor of which the boost voltage ripple voltage does not exceed 30Vp-p.

■ When the power supply is operated under -20°C, it may make the boost voltage unstable due to the characteristic of equivalent series resistor. Please choose the capacitor which has more than recommended capacitance.

Table 3.4 Recommended capacitance Cbc

No.	Model	Voltage	Cbc	Allowable capacitance range
1	TUNSS300F	DC420V	470 $\mu$ F	390 to 2200 $\mu$ F
2	TUNSS500F	or more	390 $\mu$ F X 2	390 to 2200 $\mu$ F

#### (2) C2, C3 : Capacitor for boost voltage

■ Install external capacitors C2, C3 with capacitance shown in table 3.5.

■ If capacitors C2, C3 are not installed, it may cause the failure of the power supply or external components.

Table 3.5 Recommended capacitance C2 and C3

No.	Model	Voltage	Capacitance	Rated ripple current
1	TUNSS300F	DC450V	1 $\mu$ F or more	3A or more
2	TUNSS500F		1 $\mu$ F or more	3A or more

(3) TFR1 : Inrush current limiting resistor 4.7ohm - 22ohm

■ Connect a resistor between R pin and +BC pin for inrush current protection. The surge capacity is required for TFR1, please contact component mfg. Wirewound resistor with thermal cut-offs type is required.

## 4 Function

### 4.1 Input voltage range

- The input voltage range is from 85 VAC to 264 VAC.
- In cases that conform with safety standard, input voltage range is AC100-AC240V(50/60Hz).
- Be aware that use of voltages other than those listed above may result in the unit not operating according to specifications, or may cause damage. Avoid square waveform input voltage, commonly used in UPS units and inverters.

### 4.2 Overcurrent protection

#### ● TUNS300F

- Overcurrent protection is built-in and comes into effect at over 105% of the rated current.  
Overcurrent protection prevents the unit from short circuit and overcurrent condition. The unit automatically recovers when the fault condition is cleared.
- When the output voltage drops at overcurrent, the average output current is reduced by intermittent operation of power supply.

#### ● TUNS500F

- Overcurrent protection is built-in and comes into effect at over 101% of the peak current.  
Overcurrent protection prevents the unit from short circuit and overcurrent condition. The unit automatically recovers when the fault condition is cleared.
- When the output voltage drops at overcurrent, the average output current is reduced by intermittent operation of power supply.

### 4.3 Peak current protection

#### ● TUNS500F

- Peak current protection is built-in. When the power supply is operated at over peak load based on section 7 (Peak current), this function comes into effect and reduce the output.
- A few seconds later, a unit automatically recovers. But if the over-current condition has not been released, the output will reduced again (intermittent operation mode).

### 4.4 Overvoltage protection

- Overvoltage protection circuit is built-in. If the overvoltage protection circuit is activated, shut down the input voltage, wait more than 3 minutes and turn on the AC input again to recover the output voltage. Recovery time varies depending on such factors as input voltage value at the time of the operation.

#### Remarks:

Please note that devices inside the power supply might fail when voltage of more than rated output voltage is applied to output terminal of the power supply. This could happen when the customer tests the overvoltage performance of the unit.

### 4.5 Thermal protection

- When the power supply temperature is kept above 100°C, the thermal protection will be activated and simultaneously shut down the output.  
When the thermal protection is activated, shut off the input voltage and eliminate all the overheating conditions. To recover the output voltage, keep enough time to cool down the power supply before turning on the input voltage again.

### 4.6 Remote sensing

- Remote sensing is built-in.

(1) When the remote sensing function is not in use

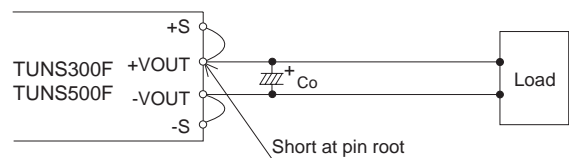

Fig. 4.1 Connection when the remote sensing is not in use

- When the remote sensing function is not in use, it is necessary to confirm that pins are shorted between +S & +VOUT and between -S & -VOUT.
- Wire between +S & +VOUT and between -S & -VOUT as short as possible.  
Loop wiring should be avoided.  
This power supply might become unstable by the noise coming from poor wiring.

(2) When the remote sensing function is in use

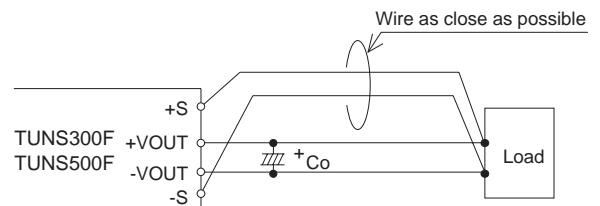

Fig. 4.2 Connection when the remote sensing is in use

- Twisted-pair wire or shield wire should be used for sensing wire.
- Thick wire should be used for wiring between the power supply and a load.  
Line drop should be less than 0.5V.  
Voltage between +VOUT and -VOUT should remain within the output voltage adjustment range.
- If the sensing patterns are short, heavy-current is drawn and the pattern may be damaged.  
The pattern disconnection can be prevented by installing the protection parts as close as a load.

■As wiring or load impedance may generate oscillation or large fluctuations in output voltage, make sure enough evaluation is given advance.

## 4.7 Adjustable voltage range

■Output voltage between +VOUT and -VOUT can be adjusted by connecting external resistors to TRM.

■When the output voltage adjustment is not used, open the TRM pin respectively.

■When the output voltage adjustment is used, note that the overvoltage protection circuit operates when output voltage is set too high.

■The wiring to the potentiometer should be as short as possible. As the ambient temperature fluctuation characteristics deteriorate depending on the types of resistors and potentiometers, please use resistors and potentiometers of the following specifications:  
Resistors..... Metal film type, coefficient less than  $\pm 100\text{ppm}/^\circ\text{C}$   
Potentiometers ... Cermet type, coefficient less than  $\pm 300\text{ppm}/^\circ\text{C}$

■Output voltage can be adjusted by connecting an external potentiometer (VR1) and resistors (R1 and R2) as shown in Fig. 4.3.

Output voltage will increase if the resistance between ② and ③ is reduced by turning the potentiometer.

Recommended values for external components are shown in Table 4.1.

Consult us if the power module is used in a different configuration.

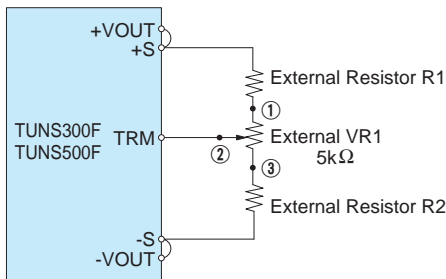

Fig. 4.3 Connecting External Devices (TUNS300F/TUNS500F)

Table 4.1 Recommended Values of External Resistors (TUNS300F, TUNS500F)

No.	Output Voltage	Adjustable Range			
		$V_{\text{OUT}} \pm 5\%$		$V_{\text{OUT}} \pm 10\%$	
		R1	R2	R1	R2
1	12V	12k $\Omega$	2.2k $\Omega$	6.8k $\Omega$	1.0k $\Omega$
2	28V	39k $\Omega$		27k $\Omega$	
3	48V	68k $\Omega$		47k $\Omega$	

## 4.8 Inverter operation monitor (IOG)

■By using the inverter operation monitor (IOG), condition of the inverter can be monitored.

The following ① or ② conditions make the IOG signal turns "H" from "L" within 1 second.

① Malfunction of inverter

② Output voltage is rapidly dropped by adjusting output voltage

Specification of IOG is shown in Table 4.2.

Table 4.2 Specification of IOG

No.	Item	IOG
1	Function	Normal operation "L"
		Malfunction of inverter "H"
2	Base pin	-S
3	Level voltage "L"	0.5V max at 10mA
4	Level voltage "H"	Open corrector
5	Maximum sink current	10mA max
6	Maximum applied voltage	35V max

## 4.9 Withstanding Voltage / Isolation Voltage

■When testing the withstanding voltage, make sure the voltage is increased gradually. When turning off, reduce the voltage gradually by using the dial of the hi-pot tester. Do not use a voltage tester with a timer as it may generate voltage several times as large as the applied voltage.

# 5 Series and Parallel Operation

## 5.1 Series operation

■Series operation is available by connecting the outputs of two or more power supplies as shown below. Output current in series connection should be lower than the lowest rated current in each unit.

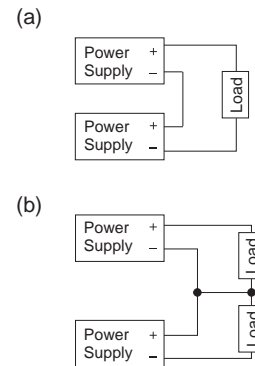

Fig. 5.1 Examples of series operation

## 5.2 Parallel operation

■Parallel operation is not possible.

■Redundancy operation is available by wiring as shown below.

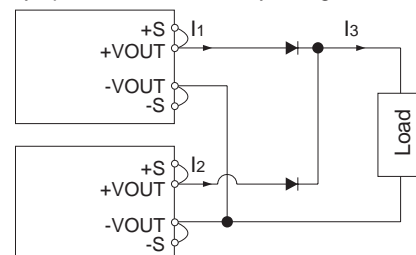

Fig. 5.2 Example of Redundancy Operation

- Even a slight difference in output voltage can affect the balance between the values of I<sub>1</sub> and I<sub>2</sub>. Please make sure that the value of I<sub>3</sub> does not exceed the rated current of a power supply.

$$I_3 \leq \text{the rated current value}$$

## 6 Implementation · Mounting Method

### 6.1 Mounting method

- The unit can be mounted in any direction. When two or more power supplies are used side by side, position them with proper intervals to allow enough air ventilation. Aluminum base plate temperature of each power supply should not exceed the temperature range shown in derating curve.
- Avoid placing the AC input line pattern layout underneath the unit. It will increase the line conducted noise. Make sure to leave an ample distance between the line pattern layout and the unit. Also avoid placing the DC output line pattern underneath the unit because it may increase the output noise. Lay out the pattern away from the unit.
- Avoid placing the signal line pattern layout underneath the unit because the power supply might become unstable. Lay out the pattern away from the unit.
- High-frequency noise radiates directly from the unit to the atmosphere. Therefore, design the shield pattern on the printed circuit board and connect it to FG. The shield pattern prevents noise radiation.

### 6.2 Stress to the pins

- When too much stress is applied to the pins may damage internal connections. Avoid applying stress in excess of that shown in Fig. 6.1.
- The pins are soldered onto the internal PCB. Therefore, Do not bend or pull the leads with excessive force.
- Mounting hole diameter of PCB should be 3.5mm to reduce the stress to the pins.
- Fix the unit on PCB (fixing fittings) by screws to reduce the stress to the pins. Be sure to mount the unit first, then solder the unit.

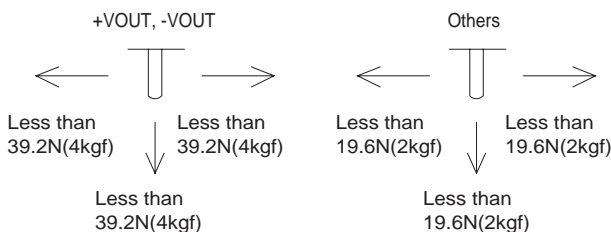

Fig. 6.1 Stress to the pins

### 6.3 Cleaning

- Clean the product with a brush. Prevent liquid from getting into the product. Do not soak the product into liquid.
- Do not stick solvent to a name plate or a resin case. (If solvent sticks to a name plate or a resin case, it will cause to change the color of the case or to fade letters on name plate away.)
- After cleaning, dry them enough.

### 6.4 Soldering temperature

- Flow soldering: 260°C for up to 15 seconds.
- Soldering iron (26W): 450°C for up to 5 seconds.

### 6.5 Derating

(1) Output voltage derating curve

- Use the power modules with conduction cooling (e.g. heat dissipation from the aluminum base plate to the attached heat sink). Fig.6.2 shows the derating curves with respect to the aluminum base plate temperature. Note that operation within the hatched areas will cause a significant level of ripple and ripple noise.
- Please measure the temperature on the aluminum base plate edge side when you cannot measure the temperature of the center part of the aluminum base plate. In this case, please take 5deg temperature margin from the derating characteristics shown in Fig.6.2. Please reduce the temperature fluctuation range as much as possible when the up and down of the temperature are frequently generated. Contact us for more information on cooling methods.

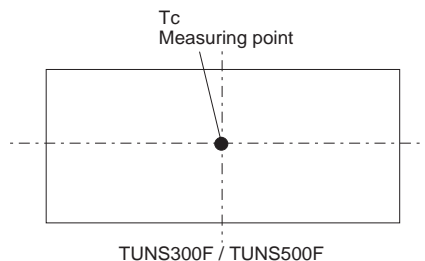
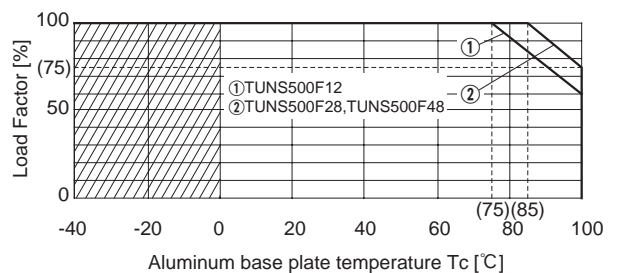
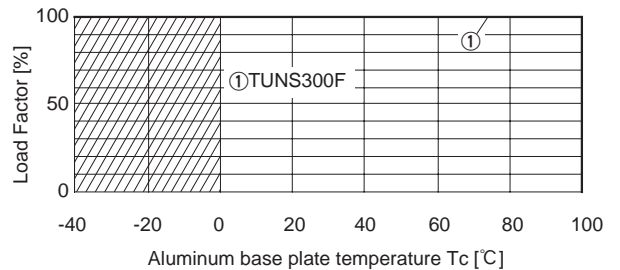

TUNS300F / TUNS500F

Fig.6.2 Derating curve

## 7 Peak current

### ●TUNS500F

■The unit can generate the peak current under the following conditions.

- $t1 \leq 10[\text{sec}]$
- $I_p \leq \text{Rated peak current}$
- $I_{\text{ave}} \leq \text{Rated current}$
- $\text{Duty} = t1 / (t1+t2) \times 100[\%] \leq 35\%$

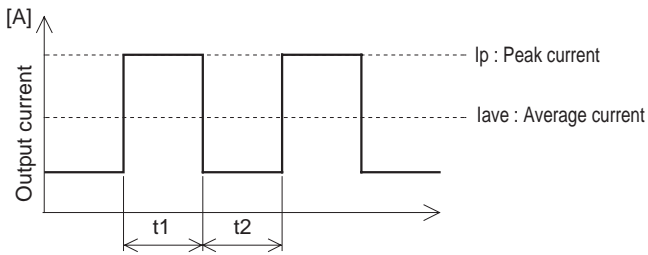

Fig. 7.1 Peak current

## 8 Lifetime expectancy depends on stress by temperature difference

■Regarding lifetime expectancy design of solder joint, following contents must be considered.

It must be careful that the soldering joint is stressed by temperature rise and down which is occurred by self-heating and ambient temperature change.

The stress is accelerated by thermal-cycling, therefore the temperature difference should be minimized as much as possible if temperature rise and down is occurred frequently.

■Product lifetime expectancy depends on the aluminum base plate central temperature difference ( $\Delta T_c$ ) and number of cycling in a day is shown in Fig.8.1.

If the aluminum base plate center part temperature changes frequently by changing output load factor etc., the above the lifetime expectancy design should be applied as well.

Please contact us for details.

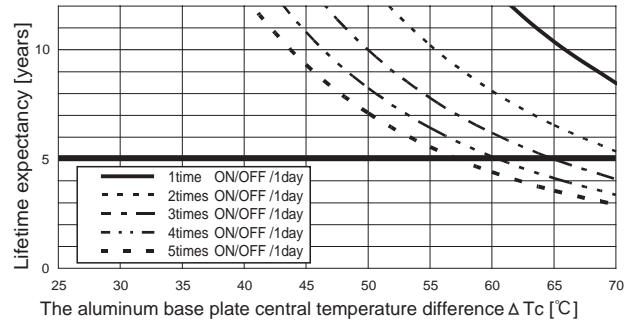

Fig.8.1 Lifetime expectancy against rise/fall temperature difference

Application manuals available at our website.

Recommended external components are also introduced for your reference.