

Material:

Housing: PA9T+30% Glass Fiber, UL 94V-0
Terminal: Copper Alloy, Gold Plated
Shell: SUS304, Nickel Plated.

PIN	SIGNAL NAME	PIN	SIGNAL NAME
A1	GND	B12	GND
A2	SSTXp1	B11	SSTXp1
A3	SSTXn1	B10	SSTXn1
A4	V _{bus}	B9	V _{bus}
A5	CC1	B8	CC1
A6	Dp1	B7	Dp1
A7	Dn1	B6	Dn1
A8	RFU1	B5	RFU1
A9	V _{bus}	B4	V _{bus}
A10	SSTXn2	B3	SSTXn2
A11	SSTXp2	B2	SSTXp2
A12	GND	B1	GND

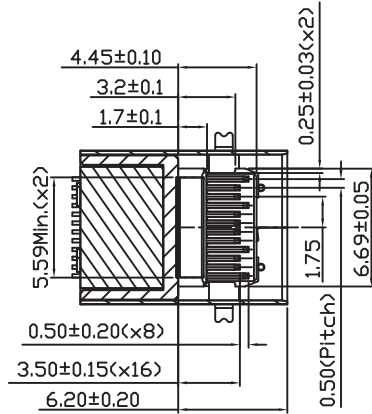
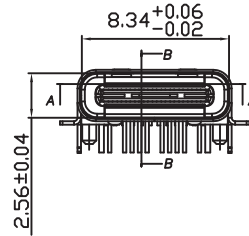
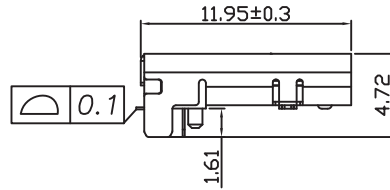
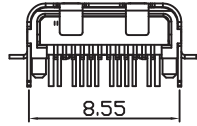

SECTION A-A

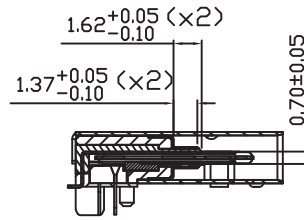
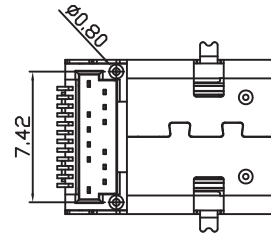

SECTION B-B

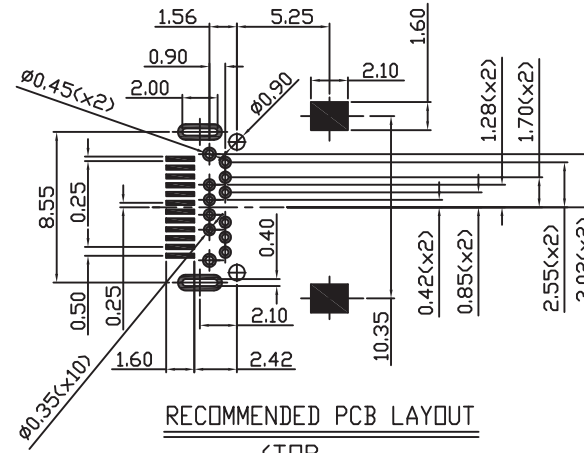

RECOMMENDED PCB LAYOUT
(TOP VIEW)

RoHS Compliant

TOLERANCES ARE

DRAWING BY CY	X ± 0.30
CHECKED BY GENIUS	.X ± 0.25
UNIT / mm	.XX ± 0.20
SCALE 1 : 1	.XXX ± 0.10
DATE	ANG ± 5°

SIZE A4

P PROJECTION

照片框

ORDER INFORMATION

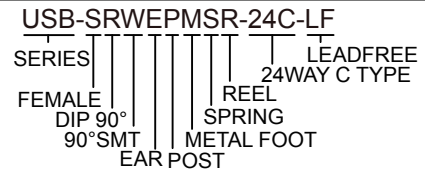

DESCRIPTION: USB TYPE C RECEPTACLE 母座板上