

- 说明：  
 1、产品料号：ZL2542-Y  
 2、塑胶材质：PA66 UL94V-2  
 3、额定电压：250V.AC/DC  
 4、额定电流：4A  
 5、耐压值：1500AC/minute  
 6、接触电阻：20mΩ (MAX)  
 7、绝缘电阻：1000MΩ (MIN)  
 8、使用温度：-25° C~+85° C

序号 SUITE	重点尺寸 Major Dimension	工具 TITL
△		卡尺
△		投影机
△		投影机
△		投影机
△		卡尺
△		投影机
△		投影机
△		卡尺

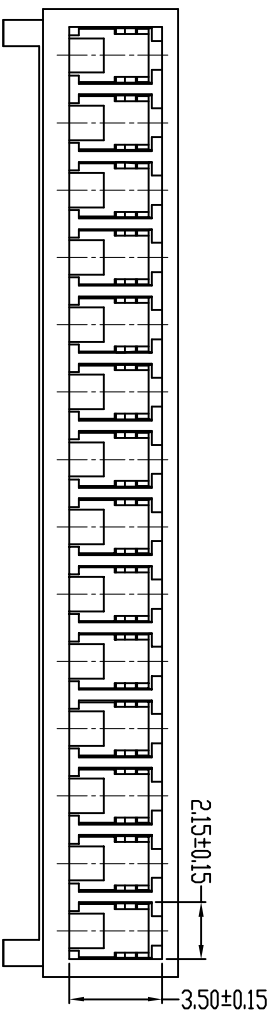
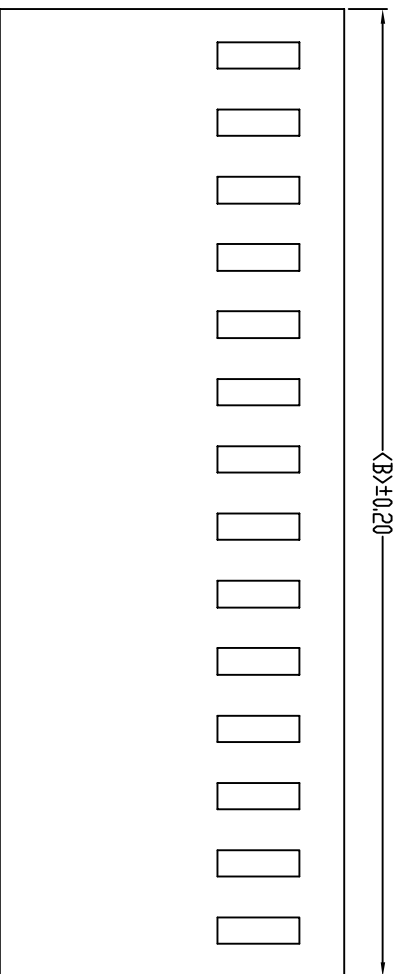

PART NO	Dimensions	
	A	B
ZL2542-Y-2P	2.54	5.80
ZL2542-Y-3P	5.08	8.35
ZL2542-Y-4P	7.62	10.80
ZL2542-Y-5P	10.16	13.45
ZL2542-Y-6P	12.70	16.10
ZL2542-Y-7P	15.24	18.60
ZL2542-Y-8P	17.78	21.15
ZL2542-Y-9P	20.32	23.75
ZL2542-Y-10P	22.86	26.15
ZL2542-Y-11P	25.40	28.90
ZL2542-Y-12P	27.94	31.35
ZL2542-Y-13P	30.48	33.90
ZL2542-Y-14P	33.02	36.40
ZL2542-Y-15P	35.56	38.90
ZL2542-Y-16P	38.10	41.40

PART NO	Dimensions	
	A	B
ZL2542-Y-2P	2.54	5.80
ZL2542-Y-3P	5.08	8.35
ZL2542-Y-4P	7.62	10.80
ZL2542-Y-5P	10.16	13.45
ZL2542-Y-6P	12.70	16.10
ZL2542-Y-7P	15.24	18.60
ZL2542-Y-8P	17.78	21.15
ZL2542-Y-9P	20.32	23.75
ZL2542-Y-10P	22.86	26.15
ZL2542-Y-11P	25.40	28.90
ZL2542-Y-12P	27.94	31.35
ZL2542-Y-13P	30.48	33.90
ZL2542-Y-14P	33.02	36.40
ZL2542-Y-15P	35.56	38.90
ZL2542-Y-16P	38.10	41.40

修改记录 REC	日期 DATE	初版发行 MODIFICATION DRAWN	变更内容 DRAWN	核准 APPROVED	图号 FILE NO	品名 TITLE	料号 PART NO	模具号 MOLD NO.	图号 DRAWN	审核 CHECKED	图号 DRAWN	审核 CHECKED	图号 DRAWN	审核 CHECKED	图号 DRAWN	审核 CHECKED	图号 DRAWN	审核 CHECKED	图号 DRAWN	审核 CHECKED	图号 DRAWN	审核 CHECKED	图号 DRAWN	审核 CHECKED
1	08/05/18	初版发行	变更内容		ZL2542-Y	2510孔座	ZL2542-Y	XXXX																

ZL2542-5PS

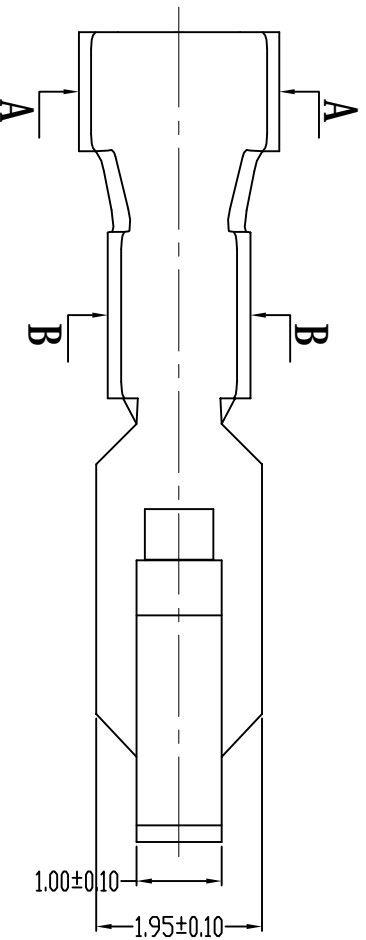

13	14
序号 SUITE	重点尺寸 Major Dimension
△1	卡尺
△2	投影机
△3	投影机
△4	投影机
△5	卡尺
△6	投影机
△7	卡尺
△8	卡尺

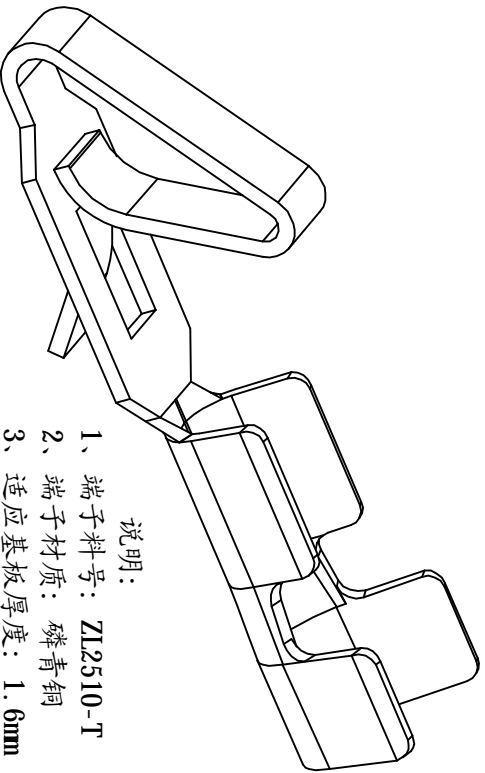
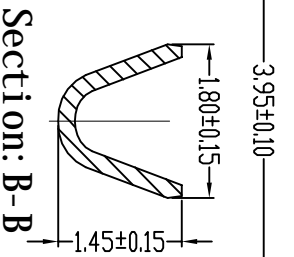
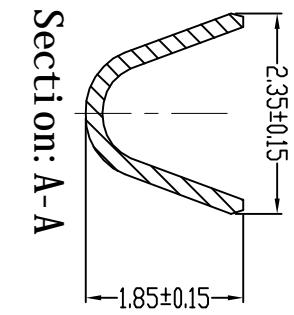
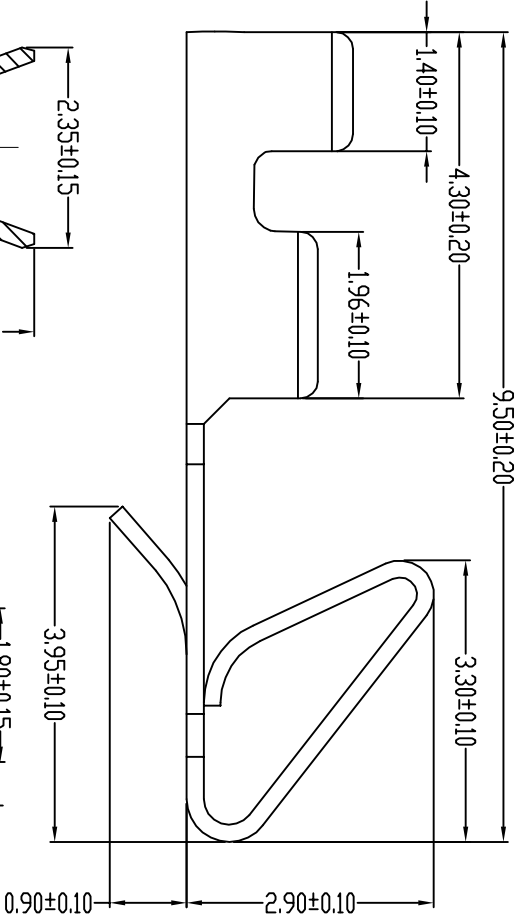

说明:

- 1、端子料号: ZL2510-T
- 2、端子材质: 磷青铜
- 3、适应基板厚度: 1.6mm
- 4、温度范围: -25° C-85° C
- 5、额定电压: 250V.AC/DC
- 6、额定电流: 4A
- 7、接触电阻: ≤ 0.02Ω
- 8、绝缘电阻: ≥ 1000MΩ
- 9、适用线规: AWG#28 ~ #22
- 10、铜皮厚度: T=0.2 ± 0.05MM

1	2	3	4	5	6	7	8	9	10	11	12	13	14	
修改日期 REC PA	日期 DATE	初版发行	变更内容 MODIFICATION DRAWN	编号 SERIAL NUMBER	更改 DRAWN	批准 APPROVED	图号 FILE NO	图名 TITLE	料号 PART NO	图号 HEAD NO	图名 DRAWN	审核 CHECKED	批准 APPROVED	页码 SHEET
1	08/10/10					⑦	ZL2510-T	2542端子	ZL2510-T					1/1

材料 MATERIAL	颜色 COLOR	比例 SCALE	SIZE
磷青铜 UNIT	mm	1:1	A4

ZL2542-5PS