

1	2	3	4	5	6	7	8	9	10	11	12	13	14																																																																																											
<p>说明:</p> <p>1、产品料号: ZL2543-Y</p> <p>2、塑胶材质: PP0 UL94V-0</p> <p>3、额定电压: 250V. AC/DC</p> <p>4、额定电流: 2.5A</p> <p>5、耐压值: 800AC/minute</p> <p>6、接触电阻: 10MΩ (MAX)</p> <p>7、绝缘电阻: 1000MΩ (MIN)</p> <p>8、使用温度: -25° C~+85° C</p>													14																																																																																											
													14																																																																																											
													14																																																																																											
													14																																																																																											
<table border="1"> <thead> <tr> <th>序号 SUITE</th> <th>重点尺寸 Major Dimension</th> <th>工具 TOOL</th> </tr> </thead> <tbody> <tr> <td>△</td> <td></td> <td>卡尺</td> </tr> <tr> <td>△</td> <td></td> <td>投影机</td> </tr> <tr> <td>△</td> <td></td> <td>投影机</td> </tr> <tr> <td>△</td> <td></td> <td>投影机</td> </tr> <tr> <td>△</td> <td></td> <td>卡尺</td> </tr> <tr> <td>△</td> <td></td> <td>投影机</td> </tr> <tr> <td>△</td> <td></td> <td>卡尺</td> </tr> <tr> <td>△</td> <td></td> <td>卡尺</td> </tr> </tbody> </table>													序号 SUITE	重点尺寸 Major Dimension	工具 TOOL	△		卡尺	△		投影机	△		投影机	△		投影机	△		卡尺	△		投影机	△		卡尺	△		卡尺	14																																																																
序号 SUITE	重点尺寸 Major Dimension	工具 TOOL																																																																																																						
△		卡尺																																																																																																						
△		投影机																																																																																																						
△		投影机																																																																																																						
△		投影机																																																																																																						
△		卡尺																																																																																																						
△		投影机																																																																																																						
△		卡尺																																																																																																						
△		卡尺																																																																																																						
<table border="1"> <thead> <tr> <th rowspan="2">PART NO</th> <th colspan="2">Dimensions</th> </tr> <tr> <th>A</th> <th>B</th> </tr> </thead> <tbody> <tr> <td>ZL2543-Y-1x2P</td> <td>2.54</td> <td>5.08</td> </tr> <tr> <td>ZL2543-Y-1x3P</td> <td>5.08</td> <td>7.62</td> </tr> <tr> <td>ZL2543-Y-1x4P</td> <td>7.62</td> <td>10.16</td> </tr> <tr> <td>ZL2543-Y-1x5P</td> <td>10.16</td> <td>12.70</td> </tr> <tr> <td>ZL2543-Y-1x6P</td> <td>12.70</td> <td>15.24</td> </tr> <tr> <td>ZL2543-Y-1x7P</td> <td>15.24</td> <td>17.78</td> </tr> <tr> <td>ZL2543-Y-1x8P</td> <td>17.78</td> <td>20.32</td> </tr> <tr> <td>ZL2543-Y-1x9P</td> <td>20.32</td> <td>22.86</td> </tr> <tr> <td>ZL2543-Y-1x10P</td> <td>22.86</td> <td>25.40</td> </tr> <tr> <td>ZL2543-Y-1x11P</td> <td>25.40</td> <td>27.94</td> </tr> <tr> <td>ZL2543-Y-1x12P</td> <td>27.94</td> <td>30.48</td> </tr> <tr> <td>ZL2543-Y-1x13P</td> <td>30.48</td> <td>33.02</td> </tr> <tr> <td>ZL2543-Y-1x14P</td> <td>33.02</td> <td>35.56</td> </tr> <tr> <td>ZL2543-Y-1x15P</td> <td>35.56</td> <td>38.10</td> </tr> <tr> <td>ZL2543-Y-1x16P</td> <td>38.10</td> <td>40.64</td> </tr> <tr> <td>ZL2543-Y-1x17P</td> <td>40.64</td> <td>43.18</td> </tr> <tr> <td>ZL2543-Y-1x18P</td> <td>43.18</td> <td>45.72</td> </tr> <tr> <td>ZL2543-Y-1x19P</td> <td>45.72</td> <td>48.26</td> </tr> </tbody> </table>													PART NO	Dimensions		A	B	ZL2543-Y-1x2P	2.54	5.08	ZL2543-Y-1x3P	5.08	7.62	ZL2543-Y-1x4P	7.62	10.16	ZL2543-Y-1x5P	10.16	12.70	ZL2543-Y-1x6P	12.70	15.24	ZL2543-Y-1x7P	15.24	17.78	ZL2543-Y-1x8P	17.78	20.32	ZL2543-Y-1x9P	20.32	22.86	ZL2543-Y-1x10P	22.86	25.40	ZL2543-Y-1x11P	25.40	27.94	ZL2543-Y-1x12P	27.94	30.48	ZL2543-Y-1x13P	30.48	33.02	ZL2543-Y-1x14P	33.02	35.56	ZL2543-Y-1x15P	35.56	38.10	ZL2543-Y-1x16P	38.10	40.64	ZL2543-Y-1x17P	40.64	43.18	ZL2543-Y-1x18P	43.18	45.72	ZL2543-Y-1x19P	45.72	48.26	14																																
PART NO	Dimensions																																																																																																							
	A	B																																																																																																						
ZL2543-Y-1x2P	2.54	5.08																																																																																																						
ZL2543-Y-1x3P	5.08	7.62																																																																																																						
ZL2543-Y-1x4P	7.62	10.16																																																																																																						
ZL2543-Y-1x5P	10.16	12.70																																																																																																						
ZL2543-Y-1x6P	12.70	15.24																																																																																																						
ZL2543-Y-1x7P	15.24	17.78																																																																																																						
ZL2543-Y-1x8P	17.78	20.32																																																																																																						
ZL2543-Y-1x9P	20.32	22.86																																																																																																						
ZL2543-Y-1x10P	22.86	25.40																																																																																																						
ZL2543-Y-1x11P	25.40	27.94																																																																																																						
ZL2543-Y-1x12P	27.94	30.48																																																																																																						
ZL2543-Y-1x13P	30.48	33.02																																																																																																						
ZL2543-Y-1x14P	33.02	35.56																																																																																																						
ZL2543-Y-1x15P	35.56	38.10																																																																																																						
ZL2543-Y-1x16P	38.10	40.64																																																																																																						
ZL2543-Y-1x17P	40.64	43.18																																																																																																						
ZL2543-Y-1x18P	43.18	45.72																																																																																																						
ZL2543-Y-1x19P	45.72	48.26																																																																																																						
<table border="1"> <thead> <tr> <th>图号 FILE NO.</th> <th>品名 TITLE</th> <th>社封2.54单排孔座 PART NO.</th> <th>模具号 MOLD NO.</th> <th>图号 DRAWN</th> <th>审核 CHECKED</th> <th>康靖 1/1</th> <th>材质 MATERIAL UNIT</th> <th>PP0</th> <th>颜色 COLOR SCALE</th> <th>黑色 1:1</th> <th>SIZE</th> <th>M</th> </tr> </thead> <tbody> <tr> <td>ZL2543-Y</td> <td>ZL2543-Y</td> <td>ZL2543-Y</td> <td>XXXX</td> <td></td> <td></td> <td></td> <td></td> <td></td> <td></td> <td></td> <td></td> <td></td> </tr> </tbody> </table>													图号 FILE NO.	品名 TITLE	社封2.54单排孔座 PART NO.	模具号 MOLD NO.	图号 DRAWN	审核 CHECKED	康靖 1/1	材质 MATERIAL UNIT	PP0	颜色 COLOR SCALE	黑色 1:1	SIZE	M	ZL2543-Y	ZL2543-Y	ZL2543-Y	XXXX										14																																																																	
图号 FILE NO.	品名 TITLE	社封2.54单排孔座 PART NO.	模具号 MOLD NO.	图号 DRAWN	审核 CHECKED	康靖 1/1	材质 MATERIAL UNIT	PP0	颜色 COLOR SCALE	黑色 1:1	SIZE	M																																																																																												
ZL2543-Y	ZL2543-Y	ZL2543-Y	XXXX																																																																																																					
<table border="1"> <thead> <tr> <th>图号 FILE NO.</th> <th>公差 TOL</th> <th>角度 Angle</th> <th>尺寸 DIM</th> <th>图号 DRAWN</th> <th>审核 CHECKED</th> <th>康靖 1/1</th> <th>材质 MATERIAL UNIT</th> <th>PP0</th> <th>颜色 COLOR SCALE</th> <th>黑色 1:1</th> <th>SIZE</th> <th>M</th> </tr> </thead> <tbody> <tr> <td>~ 3</td> <td>±0.06</td> <td></td> <td></td> <td></td> <td></td> <td></td> <td></td> <td></td> <td></td> <td></td> <td></td> <td></td> </tr> <tr> <td>3 ~ 10</td> <td>±0.10</td> <td></td> <td></td> <td></td> <td></td> <td></td> <td></td> <td></td> <td></td> <td></td> <td></td> <td></td> </tr> <tr> <td>10 ~ 20</td> <td>±0.15</td> <td></td> <td></td> <td></td> <td></td> <td></td> <td></td> <td></td> <td></td> <td></td> <td></td> <td></td> </tr> <tr> <td>20 ~ 30</td> <td>±0.20</td> <td></td> <td></td> <td></td> <td></td> <td></td> <td></td> <td></td> <td></td> <td></td> <td></td> <td></td> </tr> <tr> <td>30 ~</td> <td>±0.30</td> <td></td> <td></td> <td></td> <td></td> <td></td> <td></td> <td></td> <td></td> <td></td> <td></td> <td></td> </tr> <tr> <td>~ 3</td> <td>±1°</td> <td></td> <td></td> <td></td> <td></td> <td></td> <td></td> <td></td> <td></td> <td></td> <td></td> <td></td> </tr> </tbody> </table>													图号 FILE NO.	公差 TOL	角度 Angle	尺寸 DIM	图号 DRAWN	审核 CHECKED	康靖 1/1	材质 MATERIAL UNIT	PP0	颜色 COLOR SCALE	黑色 1:1	SIZE	M	~ 3	±0.06												3 ~ 10	±0.10												10 ~ 20	±0.15												20 ~ 30	±0.20												30 ~	±0.30												~ 3	±1°												14
图号 FILE NO.	公差 TOL	角度 Angle	尺寸 DIM	图号 DRAWN	审核 CHECKED	康靖 1/1	材质 MATERIAL UNIT	PP0	颜色 COLOR SCALE	黑色 1:1	SIZE	M																																																																																												
~ 3	±0.06																																																																																																							
3 ~ 10	±0.10																																																																																																							
10 ~ 20	±0.15																																																																																																							
20 ~ 30	±0.20																																																																																																							
30 ~	±0.30																																																																																																							
~ 3	±1°																																																																																																							
<table border="1"> <thead> <tr> <th>修改记事 REC</th> <th>日期 DATE</th> <th>初版发行</th> <th>变更内容 MODIFICATION DRAWN</th> <th>变更 DRAWN</th> <th>核准 APPROVED</th> </tr> </thead> <tbody> <tr> <td>PA</td> <td>08/09/27</td> <td></td> <td></td> <td></td> <td></td> </tr> </tbody> </table>													修改记事 REC	日期 DATE	初版发行	变更内容 MODIFICATION DRAWN	变更 DRAWN	核准 APPROVED	PA	08/09/27					14																																																																															
修改记事 REC	日期 DATE	初版发行	变更内容 MODIFICATION DRAWN	变更 DRAWN	核准 APPROVED																																																																																																			
PA	08/09/27																																																																																																							
<table border="1"> <thead> <tr> <th>修改记事 REC</th> <th>日期 DATE</th> <th>变更内容 MODIFICATION DRAWN</th> <th>变更 DRAWN</th> <th>核准 APPROVED</th> </tr> </thead> <tbody> <tr> <td>1</td> <td></td> <td></td> <td></td> <td></td> </tr> </tbody> </table>													修改记事 REC	日期 DATE	变更内容 MODIFICATION DRAWN	变更 DRAWN	核准 APPROVED	1					14																																																																																	
修改记事 REC	日期 DATE	变更内容 MODIFICATION DRAWN	变更 DRAWN	核准 APPROVED																																																																																																				
1																																																																																																								

ZL2543-6PS

1	2	3	4	5	6	7	8	9	10	11	12	13	14	
												序号 SUITE	重点尺寸 Major Dimension	工具 TOOL
												△		卡尺
												△		投影机
												△		投影机
												△		投影机
												△		卡尺
												△		投影机
												△		卡尺
												△		卡尺

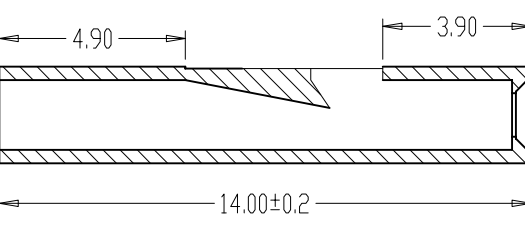
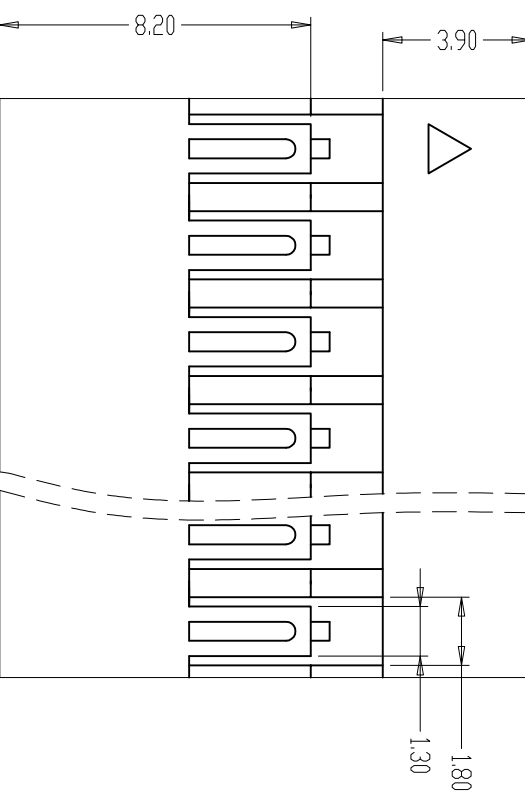
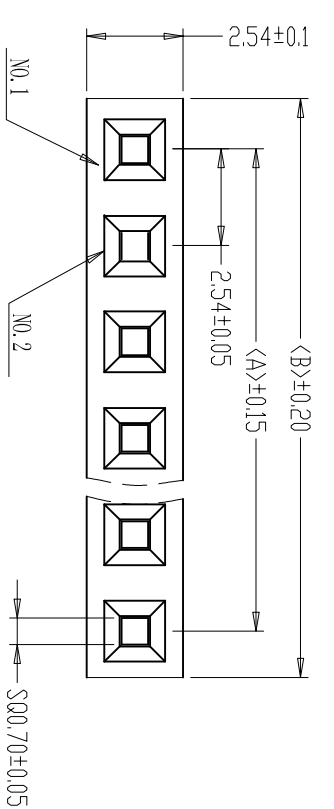
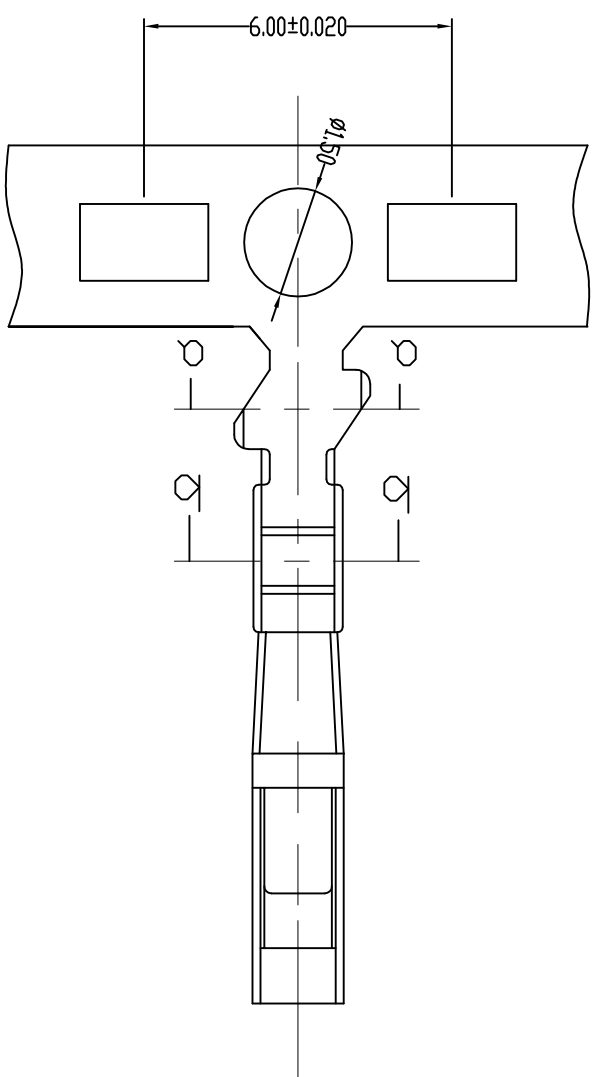

SECTION: a-a

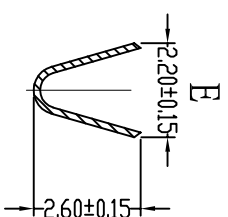

E

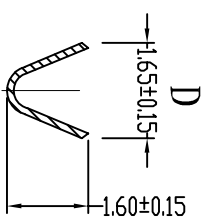

D

SECTION: b-b

- 说明:
- 1、端子料号: ZL2543-T
 - 2、端子材质: 磷青铜
 - 3、适应基板/厚度: 1.6mm
 - 4、温度范围: -25° C ~ +85° C
 - 5、额定电压: 250V. AC/DC
 - 6、额定电流: 2.5A
 - 7、接触电阻: ≤ 0.01Ω
 - 8、绝缘电阻: ≥ 1000MΩ
 - 9、适用线规: AWG#22 ~ #28

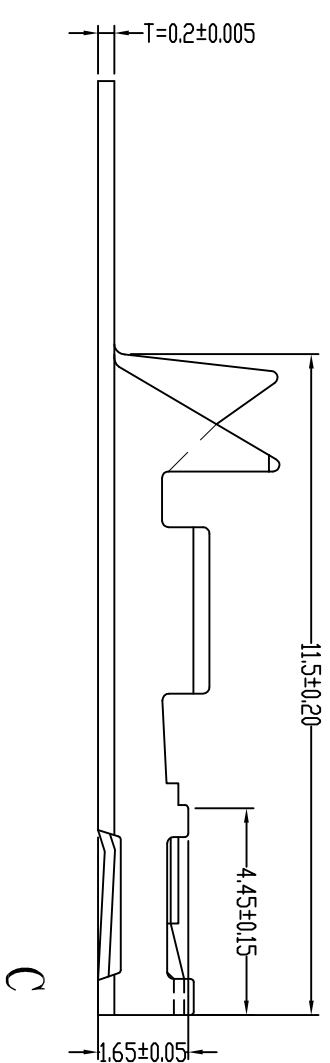

C

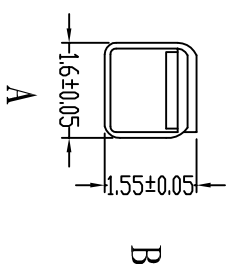

B

A

修改记事														
PA 08/9/27 初版发行														
REC 日期 08/9/27 初版发行														
MODIFICATION DRAWN 变更内容														
DRAWN 变更 DRAWN 变更 DRAWN 变更														
APPROVED 批准 APPROVED 批准 APPROVED 批准														
~ 3 ±0.06			图号 FILE NO.			ZL2543-T			DRAWN 绘图					
3 ~ 10 ±0.10			品名 TITLE			杜邦2.54端子			CHECKED 审核					
10 ~ 20 ±0.15			料号 PART NO.			ZL2543-T			APPROVED 批准					
20 ~ 30 ±0.20			模具号 MOLD NO.			XXXX			SHEET 页			1/1		
30 ~ ±0.30			Angle			± 1°			MATERIAL 材质			磷青铜		
DIM			TOL			MOLD NO.			UNIT 单位			mm		
			SCALE 比例			1:1			SIZE			M		
ZL2543-6PS												A		