

NOTES:

PART NO: ZL3963-Y

Current Rating:5A AC,DC

Voltage Rating:250V AC,DC

Temperature Range:-25°C~+120°C

Contact Resistance:20mΩ (MAX.)

Insulation Resistance:1000mΩ/min

Withstanding Voltage:1500V AC/minute

PIN Material:BRASS/TIN-Plated

Material:PA66 UL94V-0

ACCEPTS TERMINAL: ZL3963-T

ACCEPTS WAFER: ZL3963-A&A&W&AW1

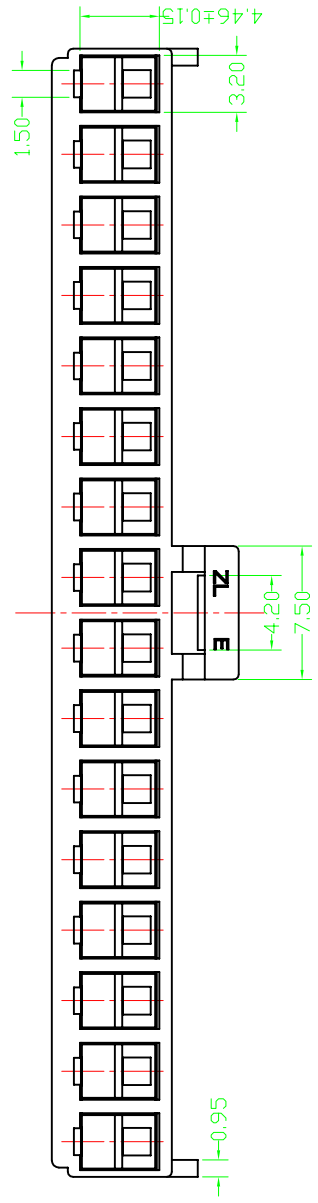
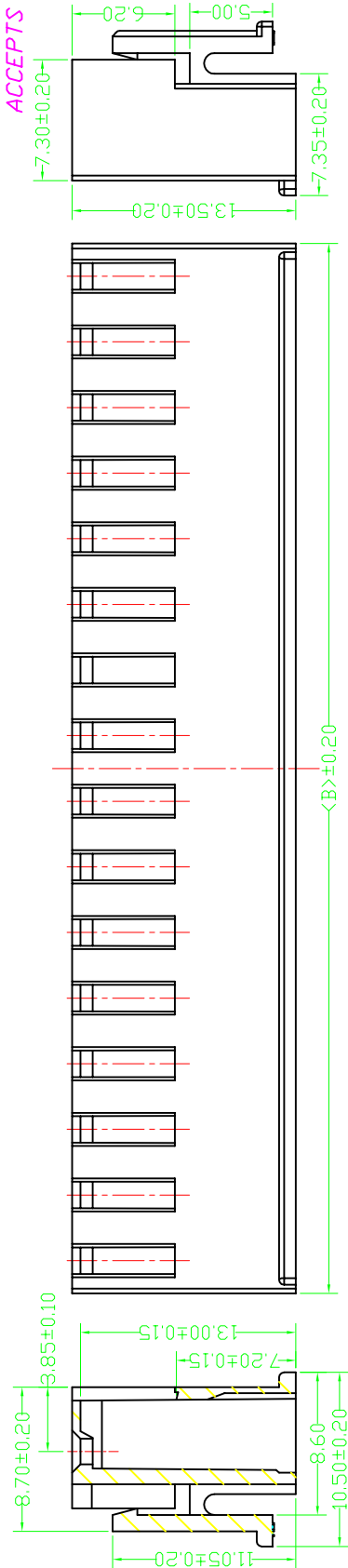
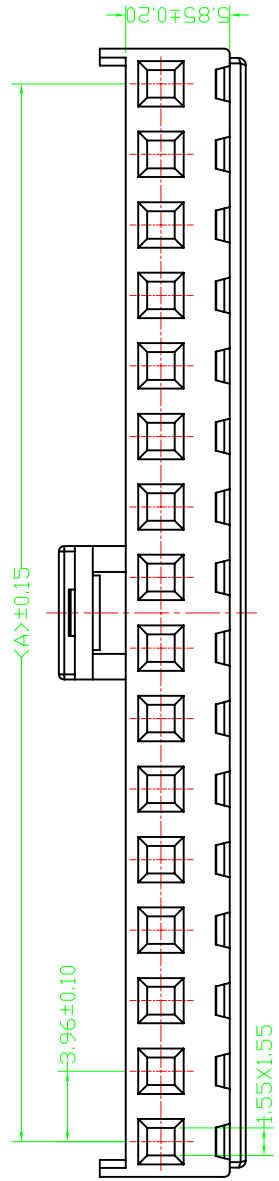

PART NO	Dimensions	
	A	B
ZL3963-Y-2P	3.96	7.92
ZL3963-Y-3P	7.92	11.88
ZL3963-Y-4P	11.88	15.84
ZL3963-Y-5P	15.84	19.80
ZL3963-Y-6P	19.80	23.76
ZL3963-Y-7P	23.76	27.72
ZL3963-Y-8P	27.72	31.68
ZL3963-Y-9P	31.68	35.64
ZL3963-Y-10P	35.64	39.60
ZL3963-Y-11P	39.60	43.56
ZL3963-Y-12P	43.56	47.52
ZL3963-Y-13P	47.52	51.48
ZL3963-Y-14P	51.48	55.44
ZL3963-Y-15P	55.44	59.40
ZL3963-Y-16P	59.40	63.36

~ 3	±0.10	FILE NO.	ZL3963-Y	DRAWN	康靖	DATE	06/07/12	SCALE		MATERIAL		UNIT		COLOR	PROJ.
3 ~ 10	±0.15	TITLE	VH3.96孔座	CHECKED				1:1		PA66	mm			白色	⊙
10 ~ 20	±0.20	PART NO.	ZL3963-Y	APPROVED				SHEET							
20 ~ 30	±0.25	REV	PA	SIZE	A4			1/1							
30 ~	±0.35														
Angle	± 2°														
DIM	TOL														
1	2	3	4	5	6	7	8	9	10	11	12	13	14		

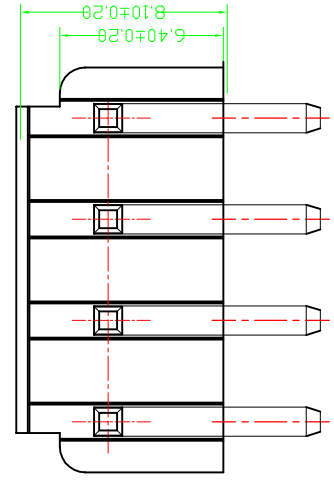
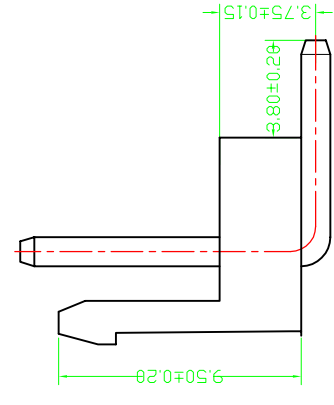
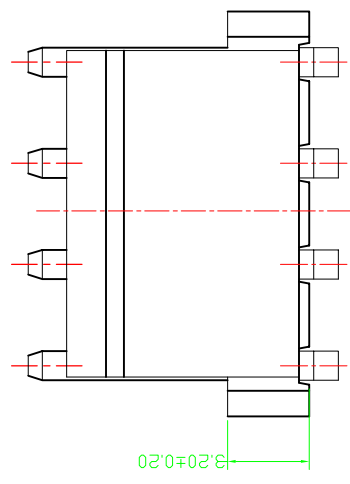
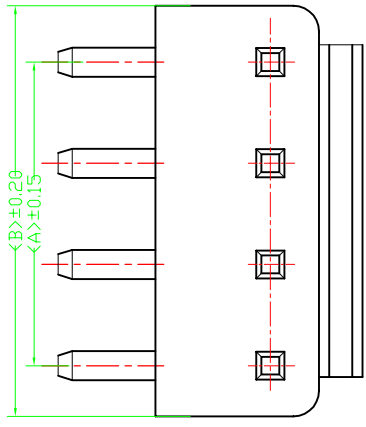

NOTES:

PART NO: ZL3963-AW
Current Rating:5A AC,DC
Voltage Rating:250V AC,DC
Temperature Range:-25°C~+120°C
Contact Resistance:20mΩ (MAX.)
Insulation Resistance:1000mΩ/ min
Withstanding Voltage:1500V AC/minute
PIN Material:BRASS/TIN-Plated
Material:PA66 UL94V-0
ACCEPTS HOUSING: ZL3963-Y

PART NO	Dimensions	
	A	B
ZL3963-AW-2P	3.96	8.44
ZL3963-AW-3P	7.92	12.40
ZL3963-AW-4P	11.88	16.36
ZL3963-AW-5P	15.84	20.32
ZL3963-AW-6P	19.80	24.28
ZL3961-AW-7P	23.76	28.24
ZL3963-AW-8P	27.72	32.20
ZL3963-AW-9P	31.68	36.16
ZL3963-AW-10P	35.64	40.12
ZL3963-AW-11P	39.60	44.08
ZL3963-AW-12P	43.56	48.04
ZL3963-AW-13P	47.52	52.00
ZL3963-AW-14P	51.48	55.96
ZL3963-AW-15P	55.44	59.92
ZL3963-AW-16P	59.40	63.88

~ 3	±0.10	FILE NO.	ZL3963-AW	DRAWN	康靖	06/07/12	SCALE	MATERIAL	UNIT	COLOR	PROJ.		
3 ~ 10	±0.15	TITLE	MX3.96 针座	CHECKED			1 : 1		mm		⊙		
10 ~ 20	±0.20	PART NO.	ZL3963-AW	APPROVED			SHEET						
20 ~ 30	±0.25	REV	PA	SIZE	A4		1/1						
30 ~	±0.35												
Angle	± 2°												
DIM	TOL												
1	2	3	4	5	6	7	8	9	10	11	12	13	14

J	I	H	G	F	E	D	C	B	A				
1	2	3	4	5	6	7	8	9	10	11	12	13	14
~ 3	±0.10	FILE NO.	ZL3963-T	DRAWN	康靖	06/07/12	SCALE	MATERIAL	UNIT	COLOR	PROJ.		
3 ~ 10	±0.15	TITLE	VH3.96端子	CHECKED			1 : 1		mm				
10 ~ 20	±0.20	PART NO.	ZL3963-T	APPROVED			SHEET						
20 ~ 30	±0.25	REV	PA	SIZE	A4		1/1						
30 ~	±0.35												
Angle	± 2°												
DIM	TOL												

NOTES:

PART NO: ZL3963-T
 MATERI: Brass
 PLATING, TIN PLATED
 THICKNESS: 0.25MM
 WIRE RANGE:#-22#
 RATED VOLTAGE: 250V AC/DC
 RATED CURRENT:5A AC/DC
 CONTACT RESISTANCE:10MΩ(MAX)
 TEMPERATURE RANGE:-25°C~+120°C
 INSULATION RESISTANCE: 1000mΩ/min
 ACCEPTS HOISING : ZL3963-Y

