

R1LV1616HBG-I Series

Wide Temperature Range Version
16 M SRAM (1-Mword × 16-bit)

REJ03C0263-0102

Rev. 1.02

Feb.20.2020

Description

The R1LV1616HBG-I Series is 16-Mbit static RAM organized 1-Mword × 16-bit with embedded ECC. R1LV1616HBG-I Series has realized higher density, higher performance and low power consumption by employing CMOS process technology (6-transistor memory cell). It offers low power standby power dissipation; therefore, it is suitable for battery backup systems. It is packaged in 48-ball plastic FBGA for high density surface mounting.

Features

- Single 3.0 V supply: 2.7 V to 3.6 V
- Fast access time: 45/55 ns (max)
- Power dissipation:
 - Active: 9 mW/MHz (typ)
 - Standby: 1.5 μW (typ)
- Completely static memory.
 - No clock or timing strobe required
- Equal access and cycle times
- Common data input and output.
 - Three state output
- Battery backup operation.
 - 2 chip selection for battery backup
- Temperature range: -40 to +85°C
- Embedded ECC (error checking and correction) for single-bit error correction

Ordering Information

Type No.	Access time	Package
R1LV1616HBG-4SI	45 ns	48-ball plastic FBGA with 0.75 mm ball pitch
R1LV1616HBG-5SI	55 ns	PTBG0048HF (48FHJ)

Pin Arrangement

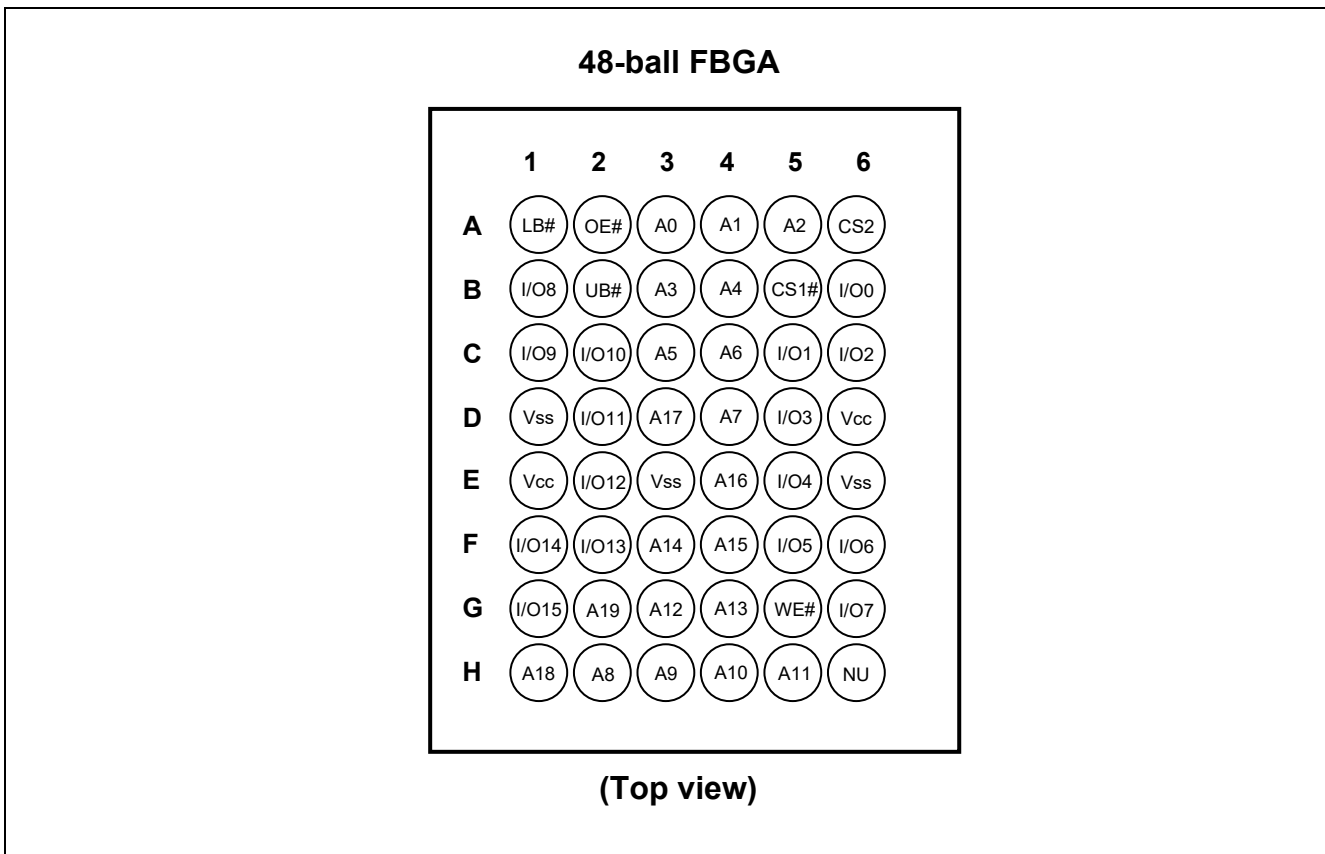

Pin Description

Pin name	Function
A0 to A19	Address input
I/O0 to I/O15	Data input/output
CS1# ($\overline{CS1}$)	Chip select 1
CS2	Chip select 2
WE# (\overline{WE})	Write enable
OE# (\overline{OE})	Output enable
LB# (\overline{LB})	Lower byte select
UB# (\overline{UB})	Upper byte select
Vcc	Power supply
Vss	Ground
NU*1	Not used (test mode pin)

Note: 1. This pin should be connected to a ground (Vss), or not be connected (open).

Block Diagram

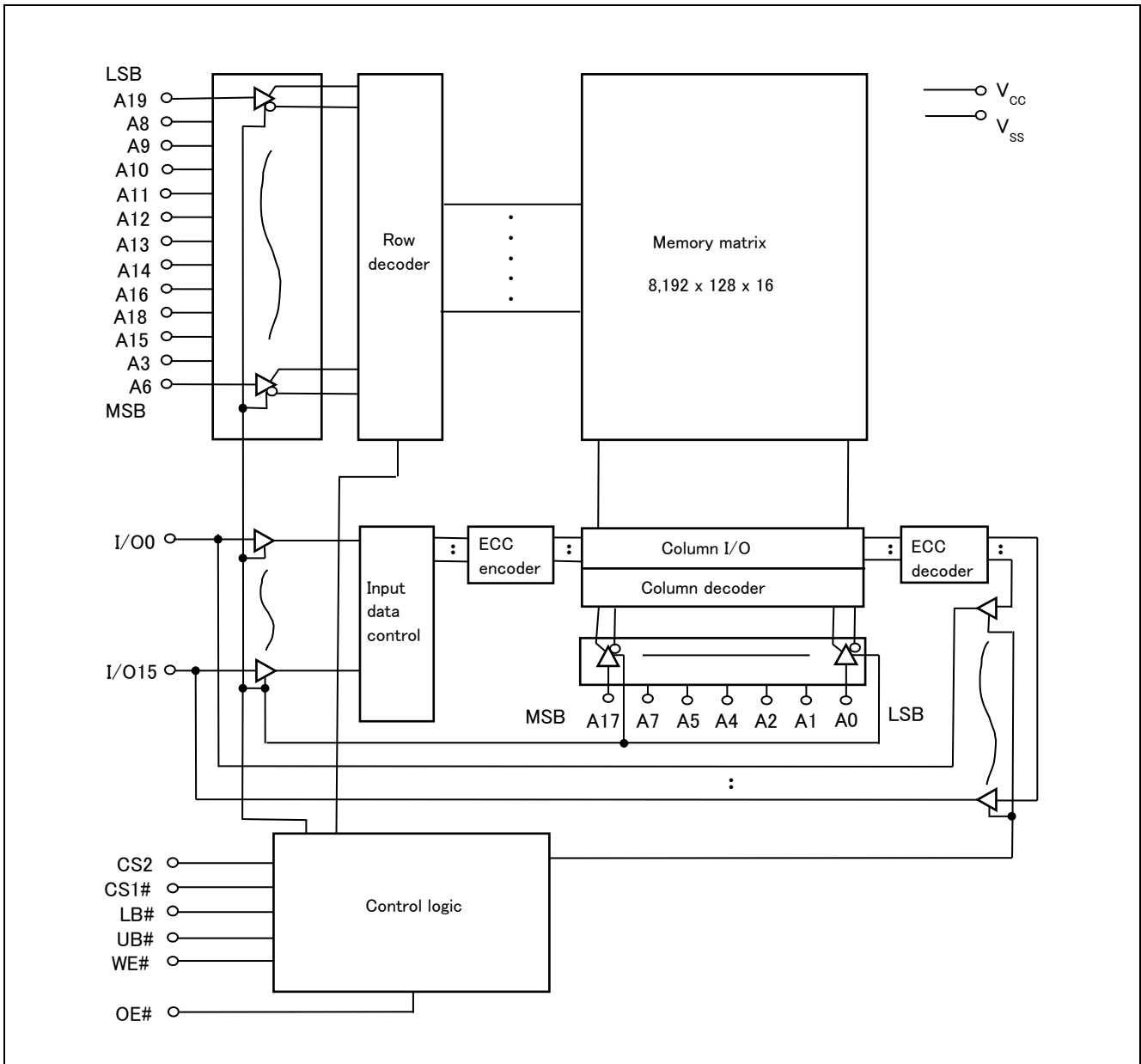

Operation Table

CS1#	CS2	WE#	OE#	UB#	LB#	I/O0 to I/O7	I/O8 to I/O15	Operation
H	×	×	×	×	×	High-Z	High-Z	Standby
×	L	×	×	×	×	High-Z	High-Z	Standby
×	×	×	×	H	H	High-Z	High-Z	Standby
L	H	H	L	L	L	Dout	Dout	Read
L	H	H	L	H	L	Dout	High-Z	Lower byte read
L	H	H	L	L	H	High-Z	Dout	Upper byte read
L	H	L	×	L	L	Din	Din	Write
L	H	L	×	H	L	Din	High-Z	Lower byte write
L	H	L	×	L	H	High-Z	Din	Upper byte write
L	H	H	H	×	×	High-Z	High-Z	Output disable

Note: H: V_{IH} , L: V_{IL} , ×: V_{IH} or V_{IL}

Absolute Maximum Ratings

Parameter	Symbol	Value	Unit
Power supply voltage relative to V_{SS}	V_{CC}	-0.5 to +4.6	V
Terminal voltage on any pin relative to V_{SS}	V_T	-0.5* ¹ to $V_{CC} + 0.3$ * ²	V
Power dissipation	P_T	1.0	W
Storage temperature range	T_{stg}	-55 to +125	°C
Storage temperature range under bias	T_{bias}	-40 to +85	°C

Notes: 1. V_T min: -2.0 V for pulse half-width ≤ 10 ns.

2. Maximum voltage is +4.6 V.

DC Operating Conditions

Parameter	Symbol	Min	Typ	Max	Unit	Note
Supply voltage	V_{CC}	2.7	3.0	3.6	V	
	V_{SS}	0	0	0	V	
Input high voltage	V_{IH}	2.2	—	$V_{CC} + 0.3$	V	
Input low voltage	V_{IL}	-0.3	—	0.6	V	1
Ambient temperature range	T_a	-40	—	+85	°C	

Note: 1. V_{IL} min: -2.0 V for pulse half-width ≤ 10 ns.

DC Characteristics

Parameter	Symbol	Min	Typ	Max	Unit	Test conditions
Input leakage current	$ I_{LI} $	—	—	1	μA	$V_{in} = V_{SS}$ to V_{CC}
Output leakage current	$ I_{LO} $	—	—	1	μA	CS1# = V_{IH} or CS2 = V_{IL} or OE# = V_{IH} or WE# = V_{IL} or LB# = UB# = V_{IH} , $V_{I/O} = V_{SS}$ to V_{CC}
Operating current	I_{CC}	—	—	20	mA	CS1# = V_{IL} , CS2 = V_{IH} , Others = V_{IH}/V_{IL} , $I_{I/O} = 0$ mA
Average operating current	I_{CC1} (READ)	—	22*1	35	mA	Min. cycle, duty = 100%, $I_{I/O} = 0$ mA, CS1# = V_{IL} , CS2 = V_{IH} , WE# = V_{IH} , Others = V_{IH}/V_{IL}
	I_{CC1}	—	30*1	50	mA	Min. cycle, duty = 100%, $I_{I/O} = 0$ mA, CS1# = V_{IL} , CS2 = V_{IH} , Others = V_{IH}/V_{IL}
	I_{CC2} (READ)	—	3*1	8	mA	Cycle time = 70 ns, duty = 100%, $I_{I/O} = 0$ mA, CS1# = V_{IL} , CS2 = V_{IH} , WE# = V_{IH} , Others = V_{IH}/V_{IL} Address increment scan or decrement scan
	I_{CC2}	—	20*1	30	mA	Cycle time = 70 ns, duty = 100%, $I_{I/O} = 0$ mA, CS1# = V_{IL} , CS2 = V_{IH} , Others = V_{IH}/V_{IL} Address increment scan or decrement scan
	I_{CC3}	—	3*1	8	mA	Cycle time = 1 μs , duty = 100%, $I_{I/O} = 0$ mA, CS1# ≤ 0.2 V, CS2 $\geq V_{CC} - 0.2$ V $V_{IH} \geq V_{CC} - 0.2$ V, $V_{IL} \leq 0.2$ V
Standby current	I_{SB}	—	0.1*1	0.5	mA	CS2 = V_{IL}
	I_{SB1}	—	0.5*1	8	μA	$0 \text{ V} \leq V_{in}$ (1) $0 \text{ V} \leq \text{CS2} \leq 0.2 \text{ V}$ or (2) CS1# $\geq V_{CC} - 0.2 \text{ V}$, CS2 $\geq V_{CC} - 0.2 \text{ V}$ or (3) LB# = UB# $\geq V_{CC} - 0.2 \text{ V}$, CS2 $\geq V_{CC} - 0.2 \text{ V}$, CS1# $\leq 0.2 \text{ V}$ Average value
Output high voltage	V_{OH}	2.4	—	—	V	$I_{OH} = -1$ mA
	V_{OH}	$V_{CC} - 0.2$	—	—	V	$I_{OH} = -100$ μA
Output low voltage	V_{OL}	—	—	0.4	V	$I_{OL} = 2$ mA
	V_{OL}	—	—	0.2	V	$I_{OL} = 100$ μA

Notes: 1. Typical values are at $V_{CC} = 3.0$ V, $T_a = +25^\circ\text{C}$ and not guaranteed.

Capacitance

(Ta = +25°C, f = 1.0 MHz)

Parameter	Symbol	Min	Typ	Max	Unit	Test conditions	Note
Input capacitance	C _{in}	—	—	8	pF	V _{in} = 0 V	1
Input/output capacitance	C _{I/O}	—	—	10	pF	V _{I/O} = 0 V	1

Note: 1. This parameter is sampled and not 100% tested.

AC Characteristics

(Ta = -40 to +85°C, V_{CC} = 2.7 V to 3.6 V)

Test Conditions

- Input pulse levels: V_{IL} = 0.4 V, V_{IH} = 2.4 V
- Input rise and fall time: 5 ns
- Input and output timing reference levels: 1.4 V
- Output load: See figures (Including scope and jig)

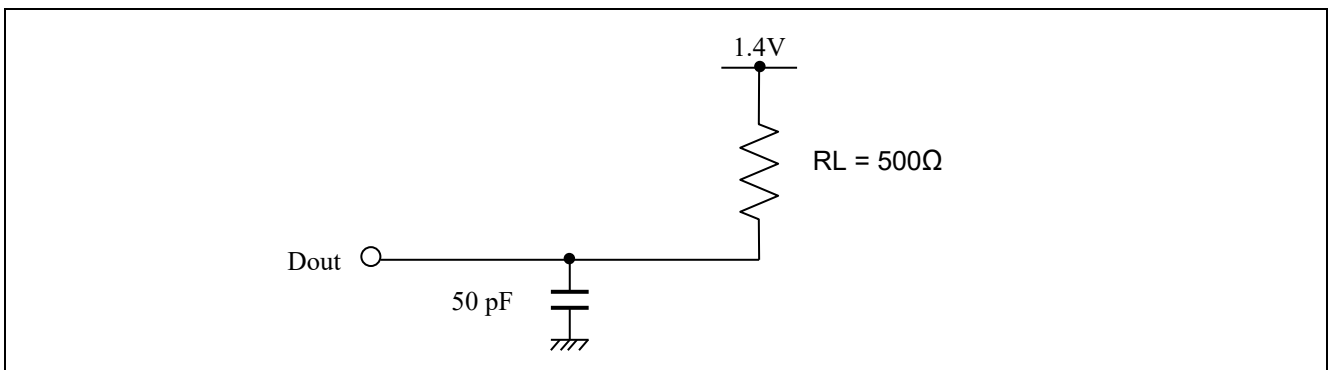

Read Cycle

Parameter	Symbol	R1LV1616HBG-I				Unit	Notes
		-4SI		-5SI			
		Min	Max	Min	Max		
Read cycle time	t _{RC}	45	—	55	—	ns	
Address access time	t _{AA}	—	45	—	55	ns	
Chip select access time	t _{ACS1}	—	45	—	55	ns	
	t _{ACS2}	—	45	—	55	ns	
Output enable to output valid	t _{OE}	—	30	—	35	ns	
Output hold from address change	t _{OH}	10	—	10	—	ns	
LB#, UB# access time	t _{BA}	—	45	—	55	ns	
Chip select to output in low-Z	t _{CLZ1}	10	—	10	—	ns	2, 3
	t _{CLZ2}	10	—	10	—	ns	2, 3
LB#, UB# enable to low-Z	t _{BLZ}	5	—	5	—	ns	2, 3
Output enable to output in low-Z	t _{OLZ}	5	—	5	—	ns	2, 3
Chip deselect to output in high-Z	t _{CHZ1}	0	20	0	20	ns	1, 2, 3
	t _{CHZ2}	0	20	0	20	ns	1, 2, 3
LB#, UB# disable to high-Z	t _{BHZ}	0	15	0	20	ns	1, 2, 3
Output disable to output in high-Z	t _{OHZ}	0	15	0	20	ns	1, 2, 3

Write Cycle

Parameter	Symbol	R1LV1616HBG-I				Unit	Notes
		-4SI		-5SI			
		Min	Max	Min	Max		
Write cycle time	t _{WC}	45	—	55	—	ns	
Address valid to end of write	t _{AW}	45	—	50	—	ns	
Chip selection to end of write	t _{CW}	45	—	50	—	ns	5
Write pulse width	t _{WP}	35	—	40	—	ns	4
LB#, UB# valid to end of write	t _{BW}	45	—	50	—	ns	
Address setup time	t _{AS}	0	—	0	—	ns	6
Write recovery time	t _{WR}	0	—	0	—	ns	7
Data to write time overlap	t _{DW}	25	—	25	—	ns	
Data hold from write time	t _{DH}	0	—	0	—	ns	
Output active from end of write	t _{OW}	5	—	5	—	ns	2
Output disable to output in high-Z	t _{OHZ}	0	15	0	20	ns	1, 2
Write to output in high-Z	t _{WHZ}	0	15	0	20	ns	1, 2

- Notes:
1. t_{CHZ}, t_{OHZ}, t_{WHZ} and t_{BHZ} are defined as the time at which the outputs achieve the open circuit conditions and are not referred to output voltage levels.
 2. This parameter is sampled and not 100% tested.
 3. At any given temperature and voltage condition, t_{HZ} max is less than t_{LZ} min both for a given device and from device to device.
 4. A write occurs during the overlap of a low CS1#, a high CS2, a low WE# and a low LB# or a low UB#. A write begins at the latest transition among CS1# going low, CS2 going high, WE# going low and LB# going low or UB# going low. A write ends at the earliest transition among CS1# going high, CS2 going low, WE# going high and LB# going high or UB# going high. t_{WP} is measured from the beginning of write to the end of write.
 5. t_{CW} is measured from the later of CS1# going low or CS2 going high to the end of write.
 6. t_{AS} is measured from the address valid to the beginning of write.
 7. t_{WR} is measured from the earliest of CS1# or WE# going high or CS2 going low to the end of write cycle.

Timing Waveform

Read Cycle

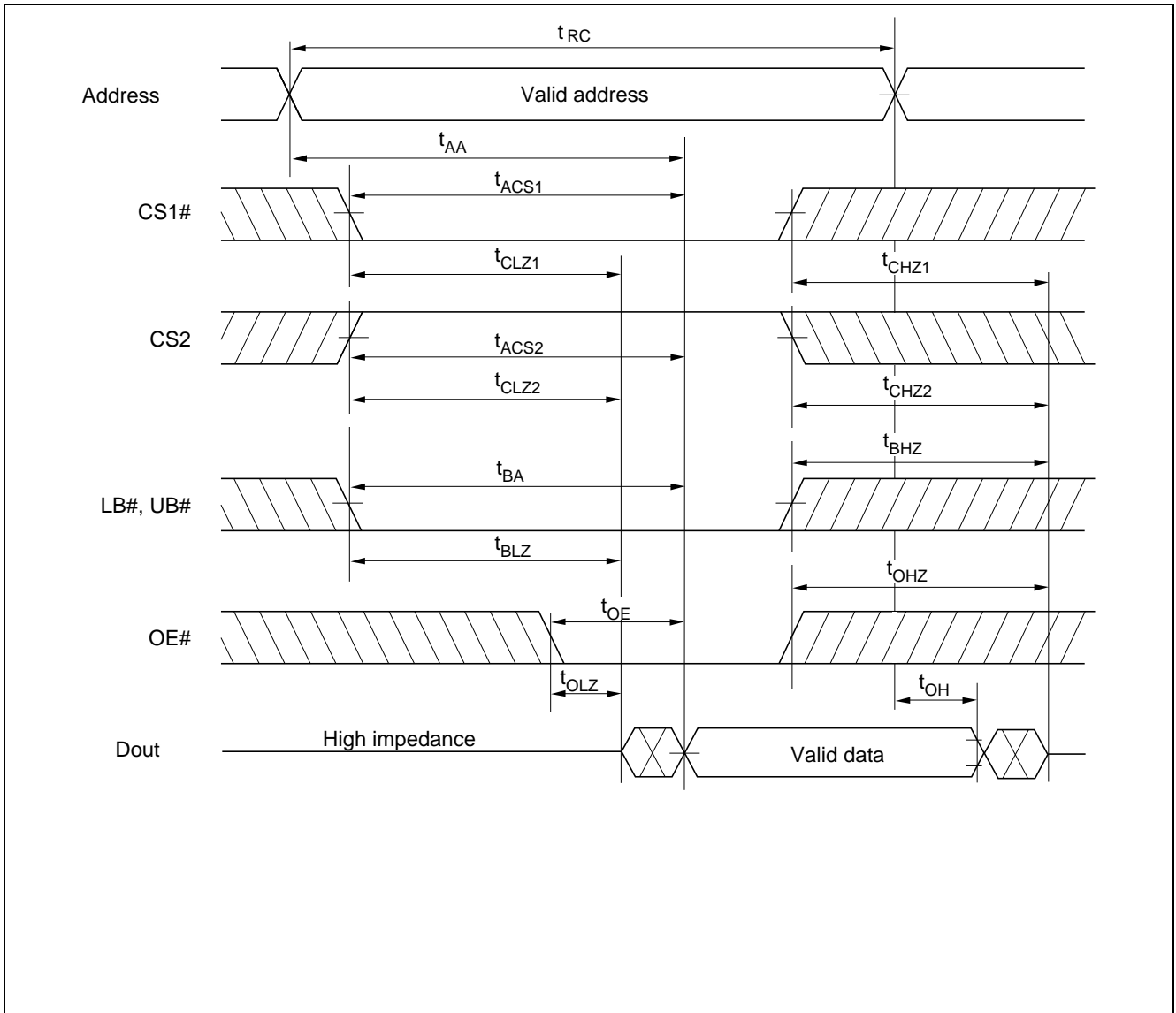

Write Cycle (1) (WE# Clock)

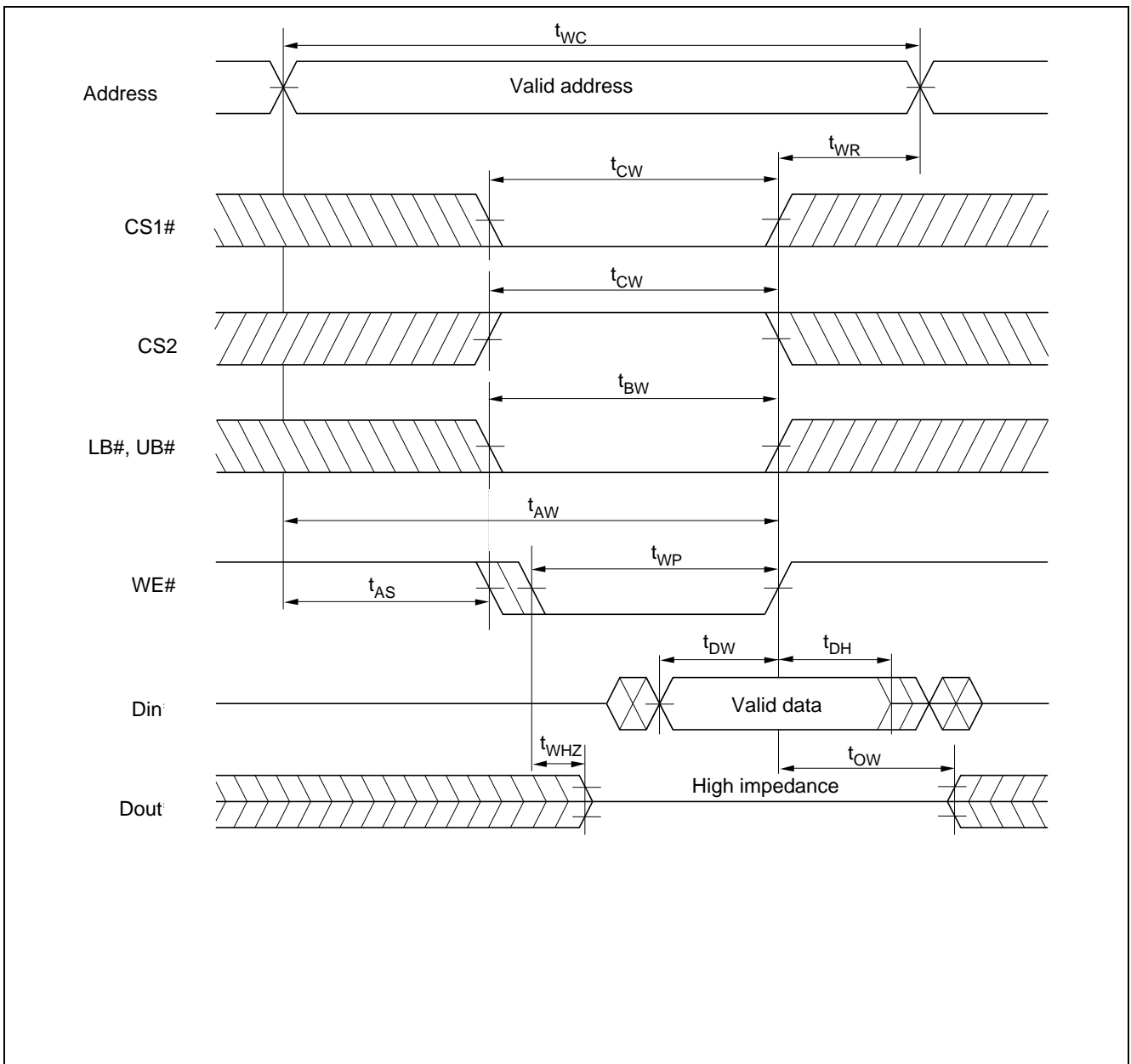

Write Cycle (2) (CS1#, CS2 Clock, OE# = V_{IH})

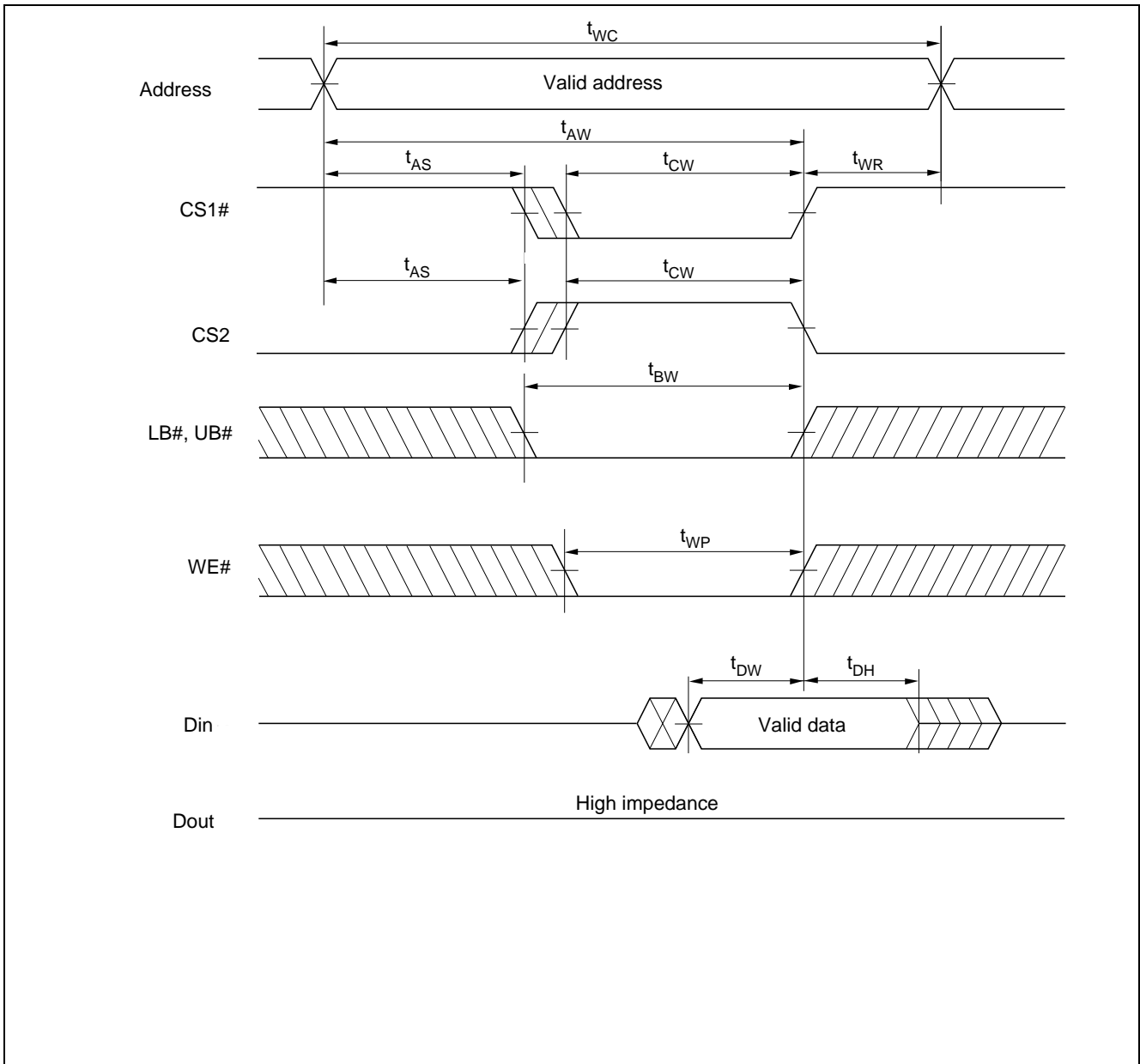

Write Cycle (3) (LB#, UB# Clock, OE# = V_{IH})

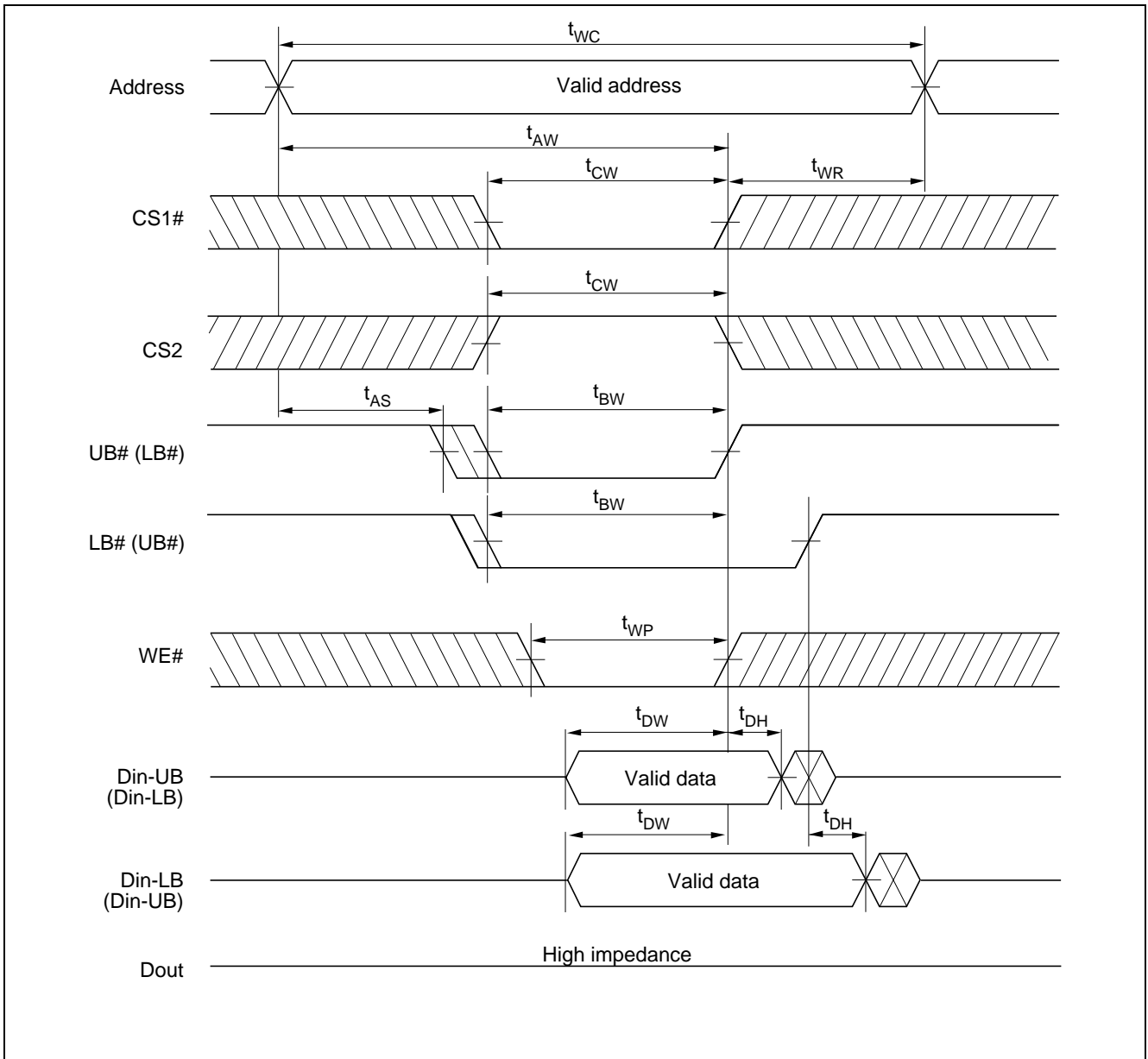

Low V_{CC} Data Retention Characteristics

(Ta = -40 to +85°C)

Parameter	Symbol	Min	Typ	Max	Unit	Test conditions*2
V_{CC} for data retention	V_{DR}	1.5	—	3.6	V	$V_{in} \geq 0$ V (1) 0 V \leq CS2 \leq 0.2 V or (2) CS2 \geq $V_{CC} - 0.2$ V, CS1# \geq $V_{CC} - 0.2$ V or (3) LB# = UB# \geq $V_{CC} - 0.2$ V, CS2 \geq $V_{CC} - 0.2$ V, CS1# \leq 0.2 V
Data retention current	I_{CCDR}	—	0.5*1	8	μ A	$V_{CC} = 3.0$ V, $V_{in} \geq 0$ V (1) 0 V \leq CS2 \leq 0.2 V or (2) CS2 \geq $V_{CC} - 0.2$ V, CS1# \geq $V_{CC} - 0.2$ V or (3) LB# = UB# \geq $V_{CC} - 0.2$ V, CS2 \geq $V_{CC} - 0.2$ V, CS1# \leq 0.2 V Average value
Chip deselect to data retention time	t_{CDR}	0	—	—	ns	See retention waveforms
Operation recovery time	t_R	5	—	—	ms	

Notes: 1. Typical values are at $V_{CC} = 3.0$ V, Ta = +25°C and not guaranteed.

2. CS2 controls address buffer, WE# buffer, CS1# buffer, OE# buffer, LB#, UB# buffer and Din buffer. If CS2 controls data retention mode, V_{in} levels (address, WE#, OE#, CS1#, LB#, UB#, I/O) can be in the high impedance state. If CS1# controls data retention mode, CS2 must be CS2 \geq $V_{CC} - 0.2$ V or 0 V \leq CS2 \leq 0.2 V. The other input levels (address, WE#, OE#, LB#, UB#, I/O) can be in the high impedance state.

Low V_{CC} Data Retention Timing Waveform (1) (CS1# Controlled)

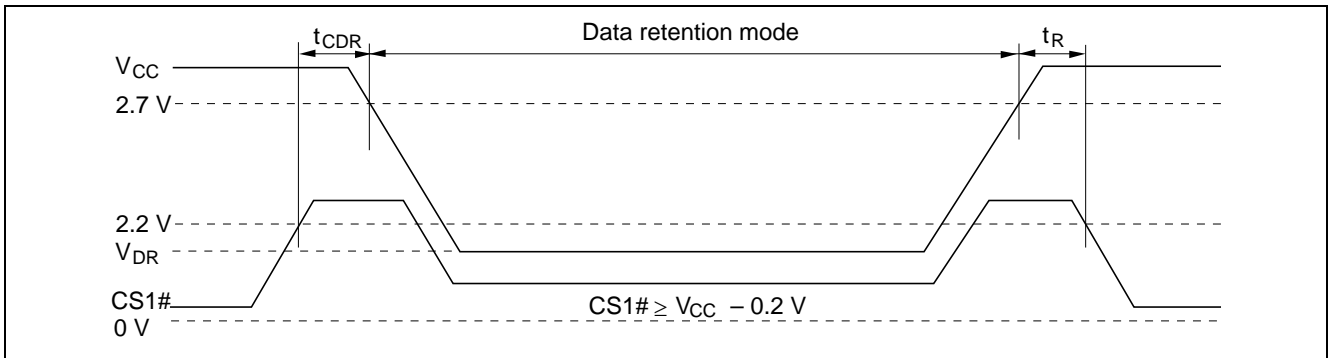

Low V_{CC} Data Retention Timing Waveform (2) (CS2 Controlled)

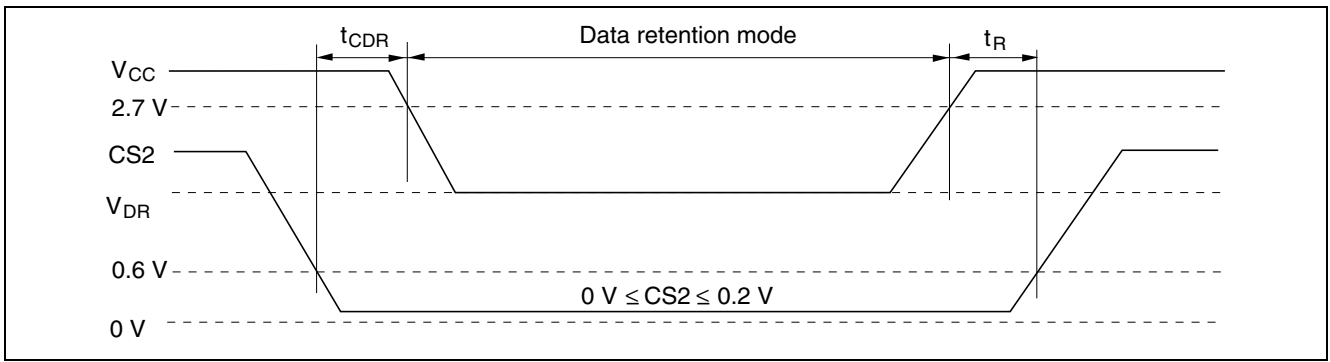

Low V_{CC} Data Retention Timing Waveform (3) (LB#, UB# Controlled)

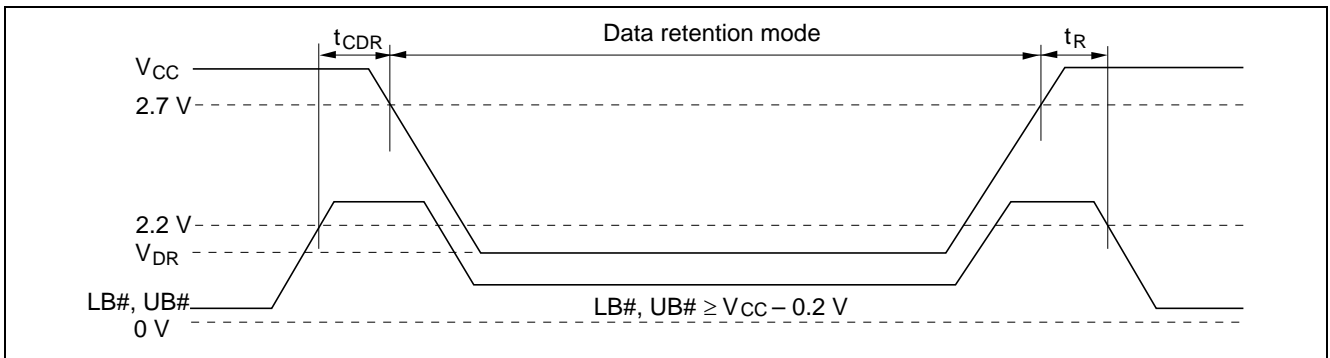

Revision History

R1LV1616HBG-I Series Data Sheet

Rev.	Date	Contents of Modification	
		Page	Description
0.01	Apr.29.2005	—	Initial issue
1.00	Sep.21.2005	—	Deletion of Preliminary
1.01	Feb.23.2017	p.1,p.3	Disclosed embedded ECC features
1.02	Feb.20.2020	Last page	Updated the Notice to the latest version

IMPORTANT NOTICE AND DISCLAIMER

RENESAS ELECTRONICS CORPORATION AND ITS SUBSIDIARIES (“RENESAS”) PROVIDES TECHNICAL SPECIFICATIONS AND RELIABILITY DATA (INCLUDING DATASHEETS), DESIGN RESOURCES (INCLUDING REFERENCE DESIGNS), APPLICATION OR OTHER DESIGN ADVICE, WEB TOOLS, SAFETY INFORMATION, AND OTHER RESOURCES “AS IS” AND WITH ALL FAULTS, AND DISCLAIMS ALL WARRANTIES, EXPRESS OR IMPLIED, INCLUDING, WITHOUT LIMITATION, ANY IMPLIED WARRANTIES OF MERCHANTABILITY, FITNESS FOR A PARTICULAR PURPOSE, OR NON-INFRINGEMENT OF THIRD PARTY INTELLECTUAL PROPERTY RIGHTS.

These resources are intended for developers skilled in the art designing with Renesas products. You are solely responsible for (1) selecting the appropriate products for your application, (2) designing, validating, and testing your application, and (3) ensuring your application meets applicable standards, and any other safety, security, or other requirements. These resources are subject to change without notice. Renesas grants you permission to use these resources only for development of an application that uses Renesas products. Other reproduction or use of these resources is strictly prohibited. No license is granted to any other Renesas intellectual property or to any third party intellectual property. Renesas disclaims responsibility for, and you will fully indemnify Renesas and its representatives against, any claims, damages, costs, losses, or liabilities arising out of your use of these resources. Renesas' products are provided only subject to Renesas' Terms and Conditions of Sale or other applicable terms agreed to in writing. No use of any Renesas resources expands or otherwise alters any applicable warranties or warranty disclaimers for these products.

(Rev.1.0 Mar 2020)

Corporate Headquarters

TOYOSU FORESIA, 3-2-24 Toyosu,
Koto-ku, Tokyo 135-0061, Japan
www.renesas.com

Contact Information

For further information on a product, technology, the most up-to-date version of a document, or your nearest sales office, please visit:
www.renesas.com/contact/

Trademarks

Renesas and the Renesas logo are trademarks of Renesas Electronics Corporation. All trademarks and registered trademarks are the property of their respective owners.