

Device Modeling Report

COMPONENTS: Digital transistors (built-in resistors)
PART NUMBER: DTC114YM
MANUFACTURER: ROHM



Bee Technologies Inc.

PSpice model parameter	Model description
IS	Saturation Current
BF	Ideal Maximum Forward Beta
NF	Forward Current Emission Coefficient
VAF	Forward Early Voltage
IKF	Forward Beta Roll-off Knee Current
ISE	Non-ideal Base-Emitter Diode Saturation Current
NE	Non-ideal Base-Emitter Diode Emission Coefficient
BR	Ideal Maximum Reverse Beta
NR	Reverse Emission Coefficient
VAR	Reverse Early Voltage
IKR	Reverse Beta Roll-off Knee Current
ISC	Non-ideal Base-Collector Diode Saturation Current
NC	Non-ideal Base-Collector Diode Emission Coefficient
NK	Forward Beta Roll-off Slope Exponent
RE	Emitter Resistance
RB	Base Resistance
RC	Series Collector Resistance
CJE	Zero-bias Emitter-Base Junction Capacitance
VJE	Emitter-Base Junction Potential
MJE	Emitter-Base Junction Grading Coefficient
CJC	Zero-bias Collector-Base Junction Capacitance
VJC	Collector-base Junction Potential
MJC	Collector-base Junction Grading Coefficient
FC	Coefficient for Onset of Forward-bias Depletion Capacitance
TF	Forward Transit Time
XTF	Coefficient for TF Dependency on Vce
VTF	Voltage for TF Dependency on Vce
ITF	Current for TF Dependency on Ic
PTF	Excess Phase at $f=1/2\pi*TF$
TR	Reverse Transit Time
EG	Activation Energy
XTB	Forward Beta Temperature Coefficient
XTI	Temperature Coefficient for IS

Input voltage vs. output current (ON characteristics)

Circuit simulation result

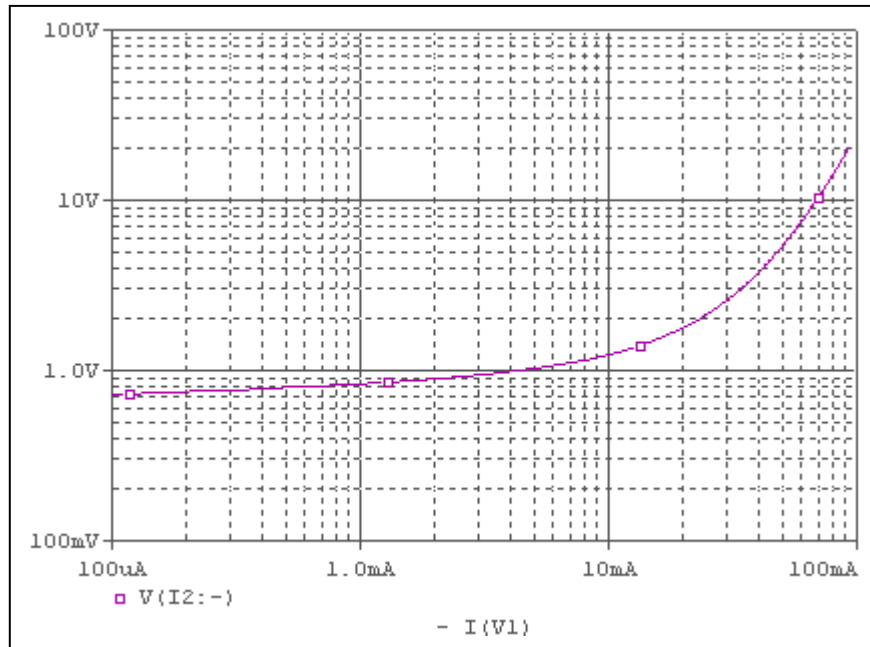

Evaluation circuit

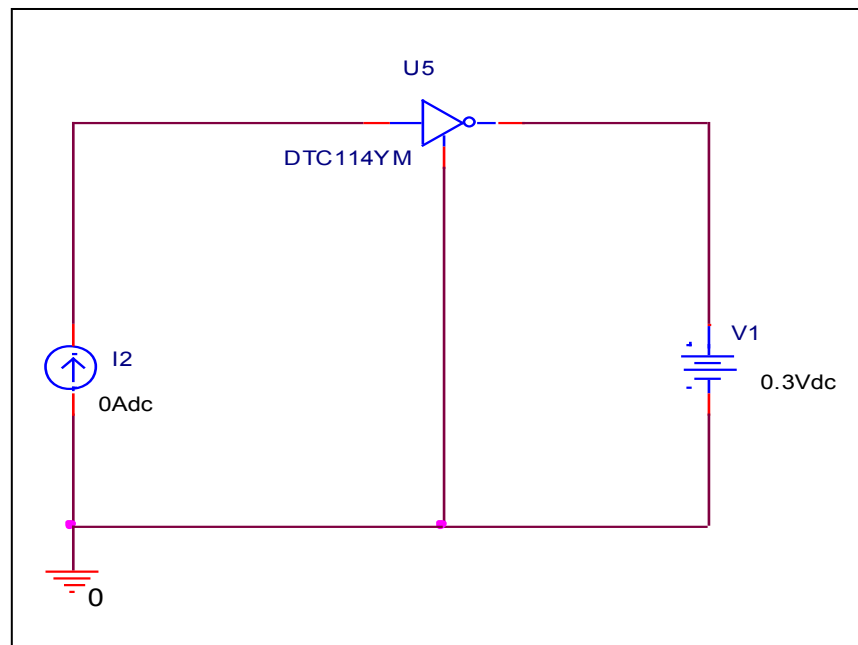

Comparison Graph

Circuit Simulation Result

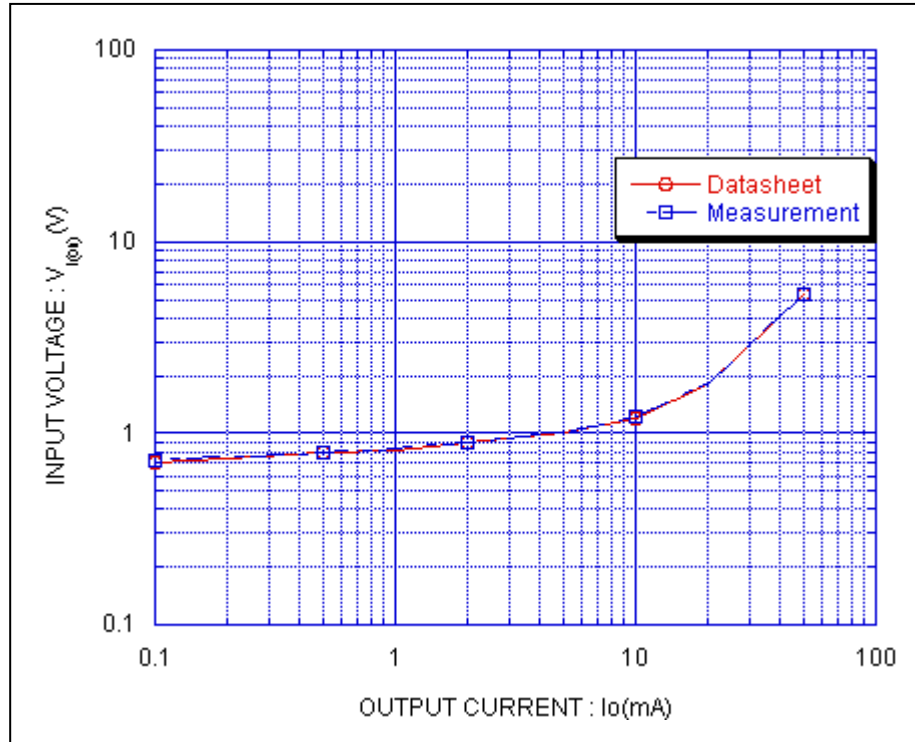

Simulation Result

Condition @ $V_o = 0.3$ V

I_o (A)	$V_{I(ON)}$ (V)		Error (%)
	Datasheet	Simulation	
100u	0.71	0.721	1.549
200u	0.74	0.75	1.351
500u	0.79	0.794	0.506
1m	0.82	0.835	1.829
2m	0.9	0.892	-0.888
5m	1	1.02	2
10m	1.2	1.23	2.5
20m	1.8	1.78	-1.111
50m	5.3	5.34	0.754

Output current vs. input voltage (OFF characteristics)

Circuit simulation result

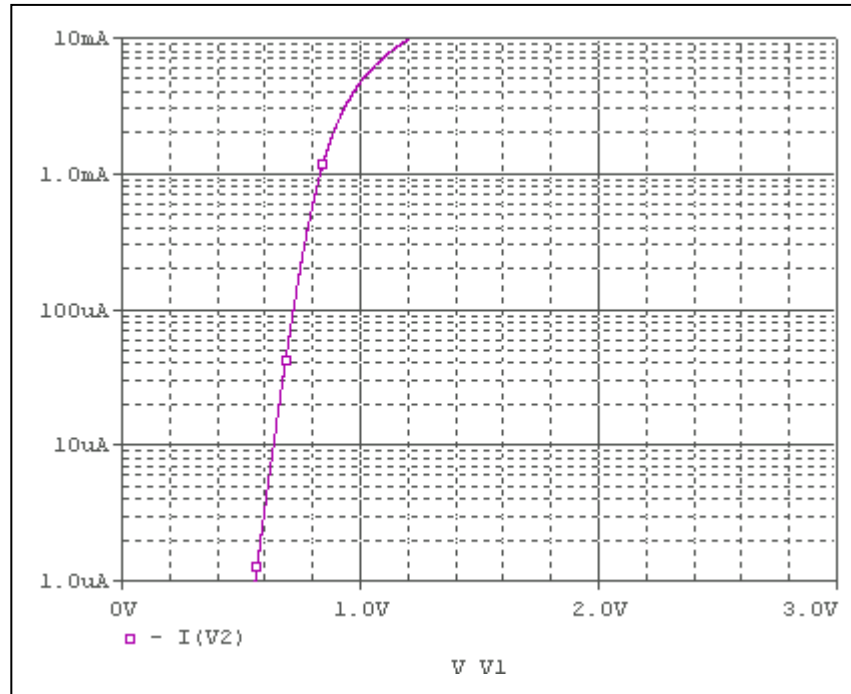

Evaluation circuit

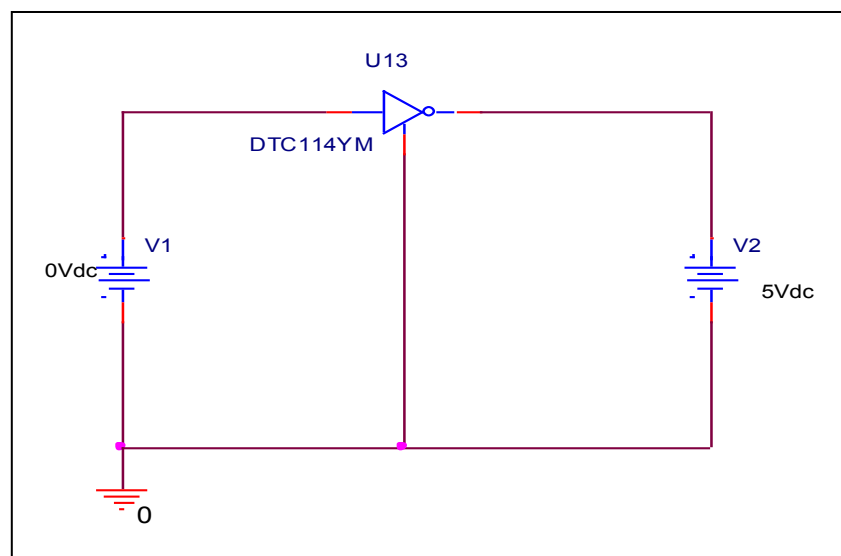

Comparison Graph

Circuit Simulation Result

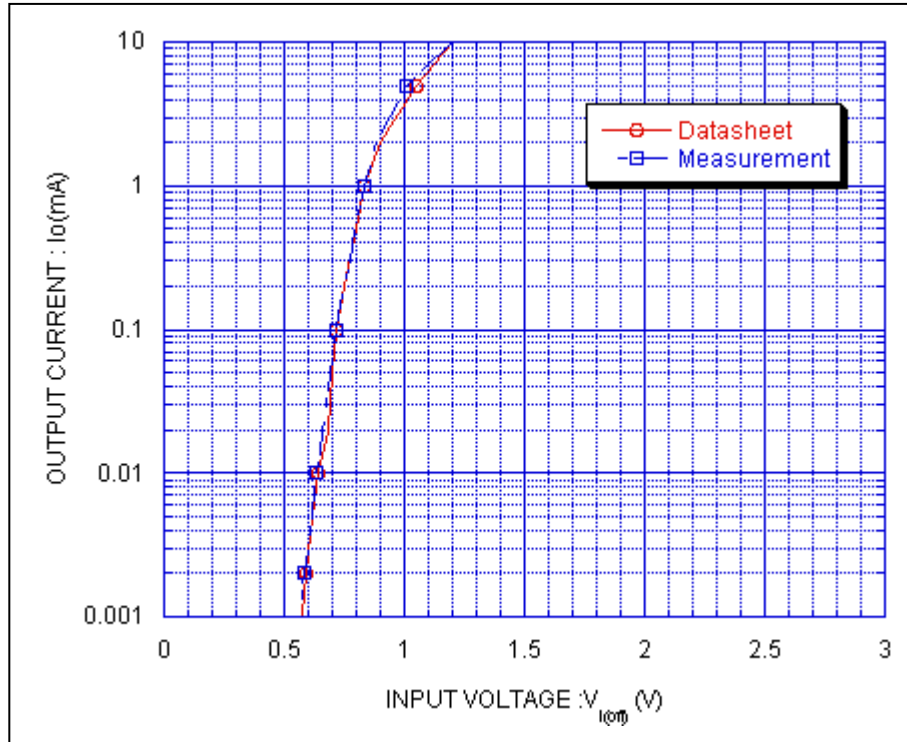

Simulation Result

Condition @ $V_{CC} = 5\text{ V}$

I_o (A)	$V_{I(off)}$ (V)		Error (%)
	Datasheet	Simulation	
1u	0.57	0.558	-2.105
2u	0.59	0.581	-1.525
5u	0.62	0.613	-1.129
10u	0.64	0.635	-0.781
20u	0.68	0.66	-2.941
50u	0.7	0.693	-1
100u	0.72	0.719	-0.138
200u	0.75	0.748	-0.266
500u	0.8	0.79	-1.25
1m	0.83	0.831	0.120
2m	0.9	0.887	-1.444
5m	1.05	1.01	-3.809
10m	1.2	1.2	0

DC current gain vs. output current

Circuit simulation result

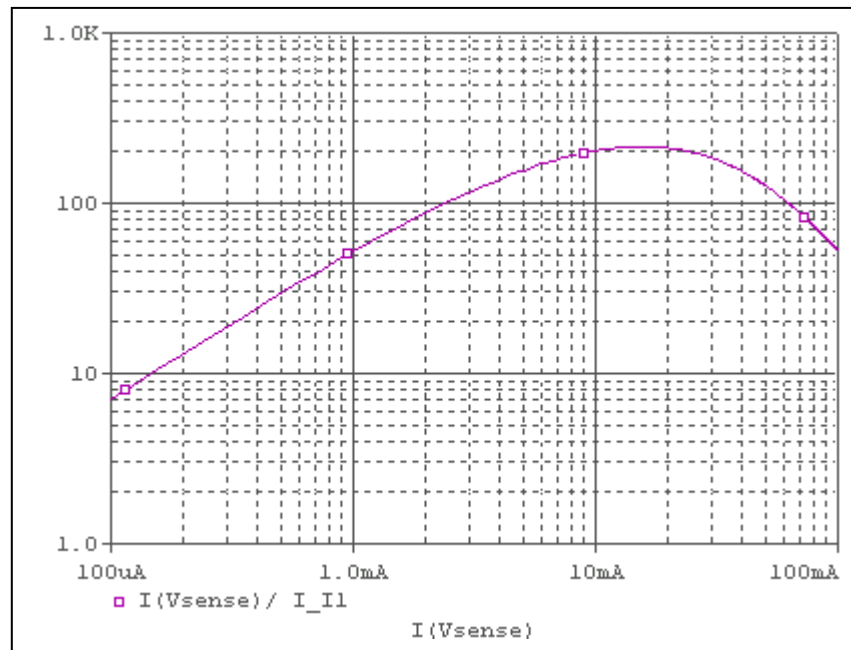

Evaluation circuit

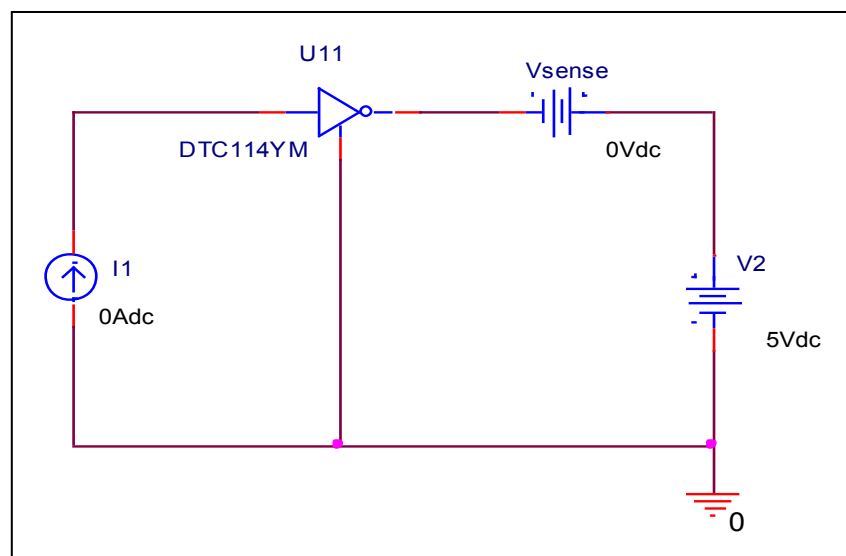

Comparison Graph

Circuit Simulation Result

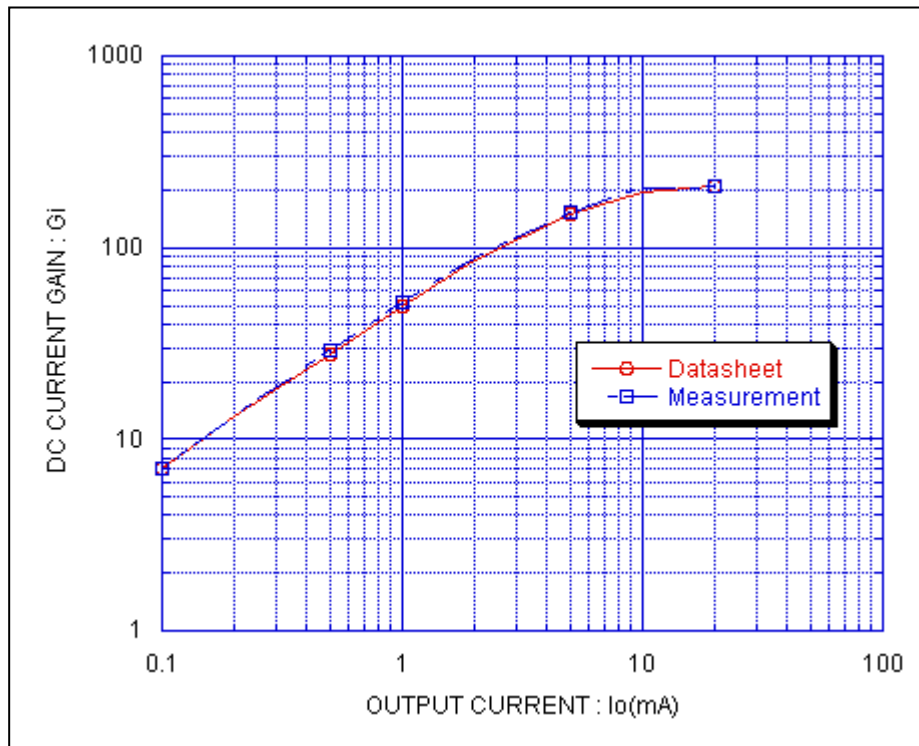

Simulation Result

Condition @ $V_{CC} = 5V$

Io(A)	Vi(Off) (V)		Error (%)
	Datasheet	Simulation	
100u	7	7.05	0.714
200u	13	13.2	1.538
500u	28	29.4	5
1m	50	52.03	4.06
2m	85	88.27	3.847
5m	150	155	3.333
10m	195	203	4.102
20m	210	210	0

Output voltage VS. output current

Circuit simulation result

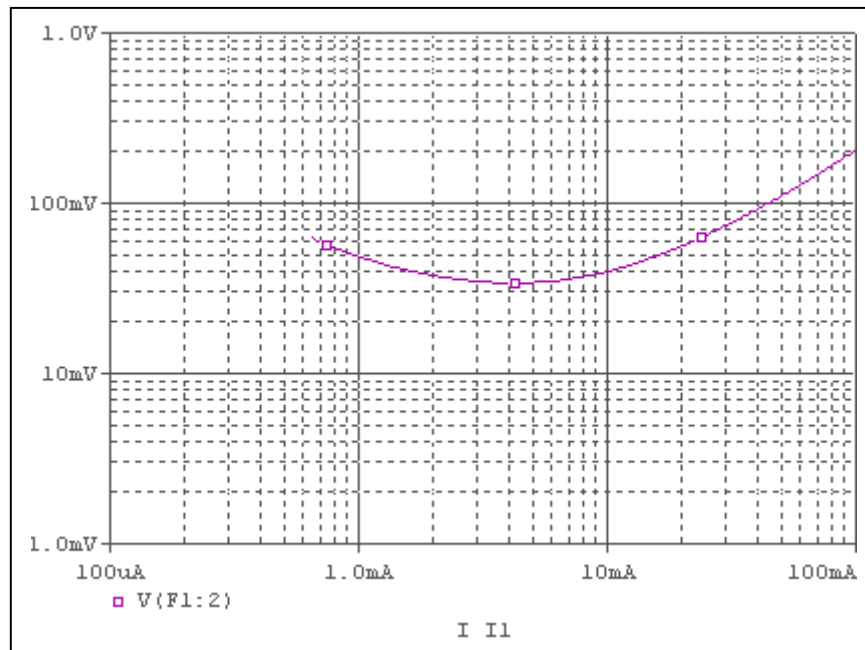

Evaluation circuit

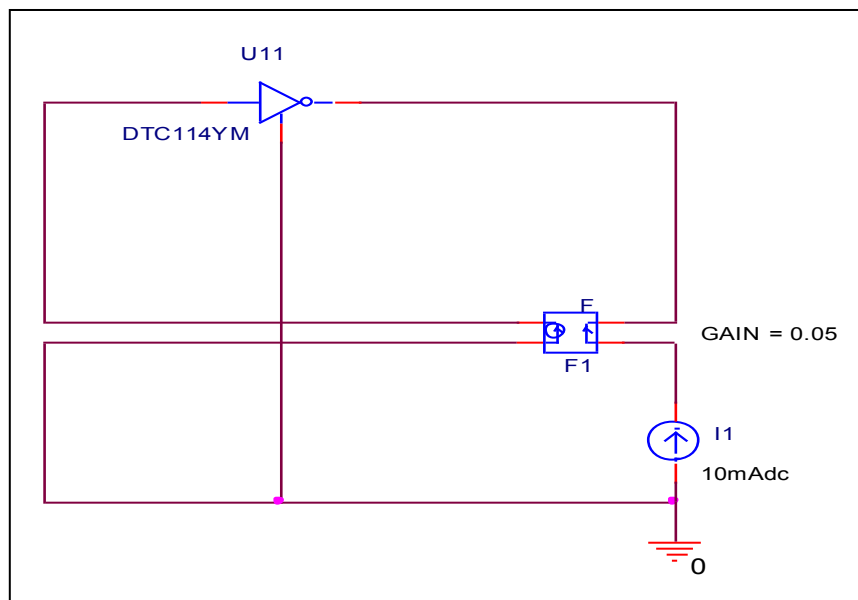

Comparison Graph

Circuit Simulation Result

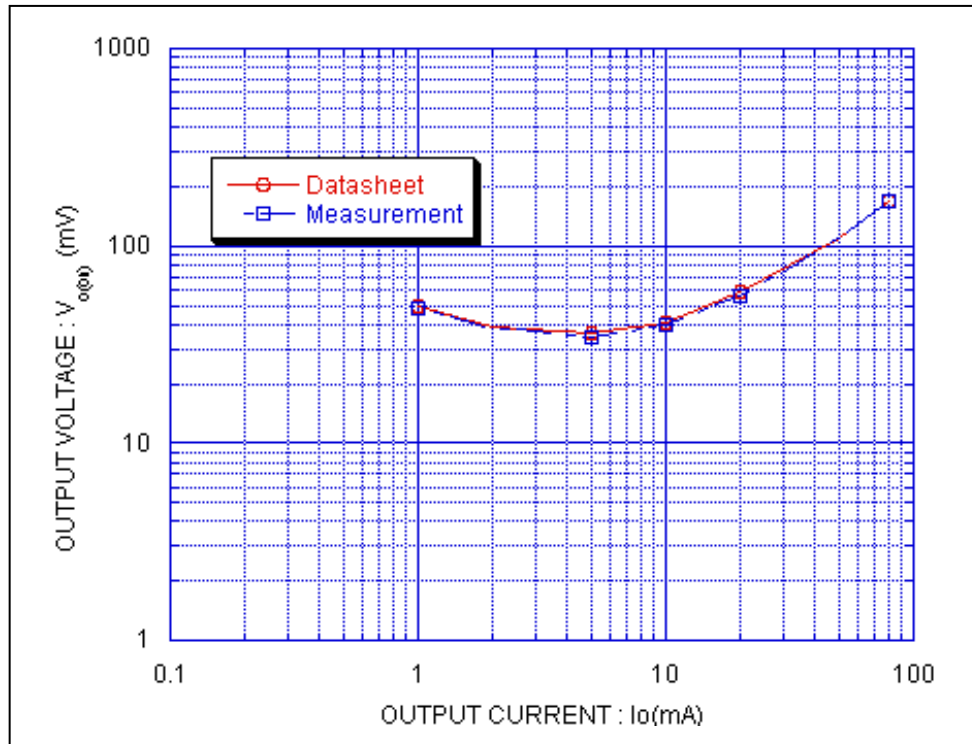

Simulation Result

Condition @ $I_o/I_i = 20$

I_o (A)	$V_{I(off)}$ (mV)		Error (%)
	Datasheet	Simulation	
1m	49	48.58	-0.857
2m	39	37.62	-3.538
5m	36	34.23	-4.916
10m	41	39.75	-3.048
20m	59	56.3	-4.576
50m	110	110	0
80m	170	167	-1.764